

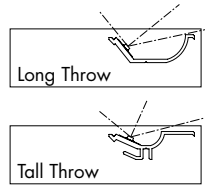

**Features**

- mCove Rectangle is a continuous wall-mounted cove system designed to provide a smooth, uniform wash of indirect light across the ceiling plane.
- mCove Rec System is a turn-key solution for complex layouts and runs - coming with pre-welded corners for installation ease.
- Shipped as field configurable strip and channel
- Suitable for wall mount applications
- Available with long throw and tall throw reflectors
- Class 2 listed for damp locations
- Warm Dim follows the incandescent dimming curve and is compatible with MLV, ELV, and Incandescent dimmers.
- Tunable White allows individual control of CCT and output, can be paired with Vintage Dim power supply for warm dim effect
- RGB offers balanced output across the color gamut and a true white with RGBW
- Smart Pixel allows for infinite color combinations with cascading and chasing effects.
- Average Life (L70): 50,000hrs
- 7 year warranty

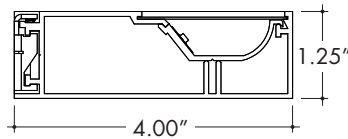
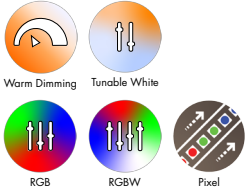

**Finish Options**

- Paint Ready
- Black powder coated
- White powder coated



**Technical Information**

TYPE	Warm Dim			Tunable White				RGB		RGBW		Pixel	
	WD51 (18K-30K)			TW51 (27K-65K)				RGB42		RGBW36		RGBX18	RGBWX18
OUTPUT OPTIONS	SO	HO	VHO	SO	HO	VHO	X2VHO	SO	HO	SO	HO	SO	SO
Lumens Output <small>(All On w/ Clear Lens)</small>	170 lm/ft	358 lm/ft	509 lm/ft	379 lm/ft	470 lm/ft	636 lm/ft	835 lm/ft	190 lm/ft	280 lm/ft	192 lm/ft	318 lm/ft	153 lm/ft	232 lm/ft
Average Power Consumption <small>(for a 4' section)</small>	2.3 W/ft	4.7 W/ft	6.9 W/ft	4.4 W/ft	5.4 W/ft	7.6 W/ft	9.5 W/ft	4.5 W/ft	8.3 W/ft	4 W/ft	7.6 W/ft	4.5 W/ft	5.7 W/ft
Efficacy	74 lm/W	76 lm/W	74 lm/W	86 lm/W	87 lm/W	84 lm/W	88 lm/W	42 lm/W	34 lm/W	48 lm/W	42 lm/W	34 lm/W	41 lm/W
Max Run Length <small>(in series)</small>	37 ft	22 ft	15 ft	27.9 ft	22 ft	15 ft	11.9 ft	28ft	14ft	26ft	13ft	30ft	20ft
Ambient Operating Temperature Range*	-4°F - 122°F <small>(-20°C - 50°C)</small>			-4°F - 122°F <small>(-20°C - 50°C)</small>				-4°F - 122°F <small>(-20°C - 50°C)</small>		-4°F - 122°F <small>(-20°C - 50°C)</small>		-4°F - 122°F <small>(-20°C - 50°C)</small>	-4°F - 122°F <small>(-20°C - 50°C)</small>
Control/Dimming Protocol	0-10V, DALI, DALI2, MLV (Triac), ELV, Inc.			0-10V, DMX, DALI-DT8				DMX, DALI-DT8		DMX, DALI-DT8		SPI Protocol UCS 2903	SPI Protocol UCS 2904

\* Ambient Operating Temperature Range to maintain L70 of 50k+ hours in normal mounting conditions for the fixture. Exceeding Ambient Operating Temperature Range may result in decreased life/output. Consult Technical Support for specific inquiries.

**Warm Dim (WD51)**

CCT	Multiplier <small>(ref. - 18K30K)</small>	TM-30			
		CRI	R <sub>f</sub>	R <sub>g</sub>	R <sub>9</sub>
18K24K	1800K	92	85	91	86
	2400K	96	95	104	97
18K27K	1800K	92	85	91	86
	2700K	96	95	104	96
18K30K	1800K	92	85	91	86
	3000K	95	95	104	90

**Tunable White (TW51)**

CCT	Multiplier <small>(ref. - 27K65K)</small>	TM-30			
		CRI	R <sub>f</sub>	R <sub>g</sub>	R <sub>9</sub>
18K30K	1800K	92	85	91	86
	2400K	95	93	106	98
	3000K	97	94	104	95
27K65K	2700K	97	95	103	93
	4200K	96	93	105	95
	6500K	91	90	101	63

**RGBW (3000K)**

Tape	TM-30			
	CRI	R <sub>f</sub>	R <sub>g</sub>	R <sub>9</sub>
RGBW36	95	93	106	84
RGBWX18	93	91	99	64

**Dominant Wavelength**

Color	RGB42/RGBW36	RGBX18/RGBWX18
Red	620nm	621nm
Green	525nm	519nm
Blue	467nm	465nm

**Ordering Code**

MODEL	SHAPE	LENGTH <sup>1</sup>	OUTPUT <sup>2</sup>	CCT	REFLECTOR	FINISH
MREC - mCove Rectangle	STR - Straight Run CMX - Complex Shape	Overall System Length in Inches (1/16) EX: <u>1249.0625</u>	WD51SO - Standard WD51HO - High WD51VHO - Very High	18K24K - 1800K - 2400K 18K27K - 1800K - 2700K 18K30K - 1800K - 3000K	LT - Long Throw TT - Tall Throw	BASE PR - Paint Ready
	UIC - U-Shape, Inside Corner UOC - U-Shape, Outside Corner	Leg 1 X Leg 2 X Leg 3 in Inches (1/16) EX: <u>115.0625 X 13.50 X 235.125</u>	TW51SO - Standard TW51HO - High TW51VHO - Very High TW51X2VHO - Very High	18K30K - 1800K - 3000K 27K65K - 2700K - 6500K		POWDER COAT BK - Black WH - White
	LIC - L-Shape, Inside Corner LOC - L-Shape, Outside Corner RECIC - Rectangle, Inside Corner RECOC - Rectangle, Outside Corner	Leg 1 X Leg 2 in Inches (1/16) EX: <u>115.0625 X 13.50</u>	RGBW36SO - Standard RGBW36HO - High RGB42SO - Standard RGB42HO - High	CLR - Color		
			RGBWX18SO - Standard RGBX18SO - Standard	PXSPI - Smart Pixel Control		

1 - Length written in decimal format to the closest sixteenth of an inch.  
2 - Title 24 JA8 achievable depending on Output, CCT, and Lens selections. See multiplier charts to calculate specific efficacies.

**Applications**

Wall Mount Cove

Fixture mounted on wall for indirect uplight.

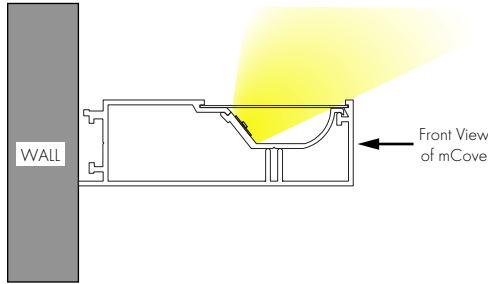

**Light Transmission and Dotting**

Output Options	Lens/Accessory							
	Long Throw Reflector				Tall Throw Reflector			
	100%	50%	10%	1%	100%	50%	10%	1%
WD51SO	CD	CD	CD	CD	CD	CD	CD	CD
WD51HO	CD	CD	CD	CD	CD	CD	CD	CD
WD51VHO	CD	CD	CD	CD	CD	CD	CD	CD
TW51SO (All On)	CD	CD	CD	CD	CD	CD	CD	CD
TW51HO (All On)	CD	CD	CD	CD	CD	CD	CD	CD
TW51VHO (All On)	CD	CD	CD	CD	CD	CD	CD	CD
TW51SO (1 CH)	CD	CD	CD	CD	CD	CD	CD	CD
TW51HO (1 CH)	CD	CD	CD	CD	CD	CD	CD	CD
TW51VHO (1 CH)	CD	CD	CD	CD	CD	CD	CD	CD
TW51X2VHO (All On)	CD	CD	CD	CD	CD	CD	CD	CD
TW51X2VHO (1 CH)	CD	CD	CD	CD	CD	CD	CD	CD
RGBW36SO	CD	CD	CD	CD	CD	CD	CD	CD
RGBW36HO	CD	CD	CD	CD	CD	CD	CD	CD
RGB42SO	CD	CD	CD	CD	CD	CD	CD	CD
RGB42HO	CD	CD	CD	CD	CD	CD	CD	CD
RGBWX18SO	CD	CD	CD	CD	CD	CD	CD	CD
RGBX18SO	CD	CD	CD	CD	CD	CD	CD	CD
<b>Transmission Percentage</b>	100%				100%			

Fixture uses indirect lighting, will have clear dotting if looking from above the fixture

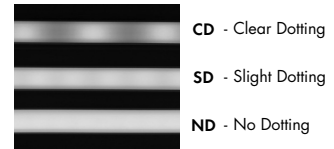

Use complete Dotting Chart Tool online for more dotting information

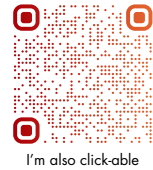

I'm also click-able

**Product Dimensions**

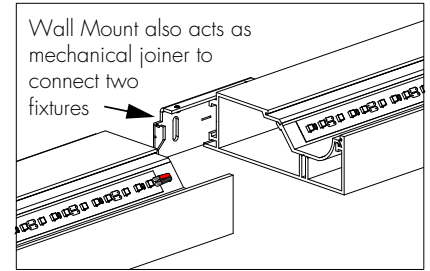
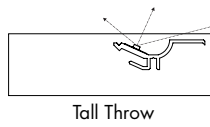
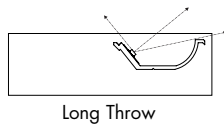
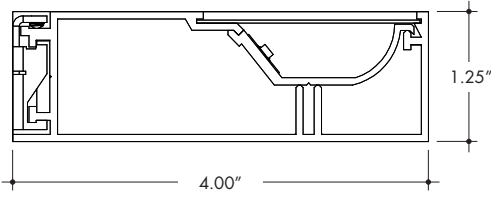

**Finish Options**

- Finish options are available in a wide variety, allowing for complete customization of style and aesthetic.
- Non Base finishes may have extended lead times and price adder.
- Custom RALs are available, please consult Inside Sales with specific request.

**Paint Ready Base**



Paint Ready is designed for easy field painting and custom color matching

**Black Powder Coat**



Black is a true deep black with a glossy finish.

**White Powder Coat**



White is a polar bright white and field paintable.

**mCove Rectangle (Remote) - What's Included**

**A - MCove Rec Straight Extrusion**

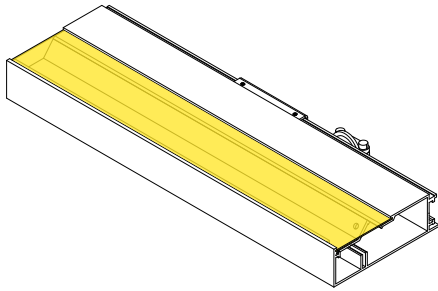

Included with mCove Rectangle System, the mCove Straight extrusion is the main architectural housing for the majority of the system run. It includes LED Strip, lens, mounting brackets, mounting screws, a conduit connector, and a reflector. Provided in lengths of 72"/144"

**B - MCove Rec Endcap**

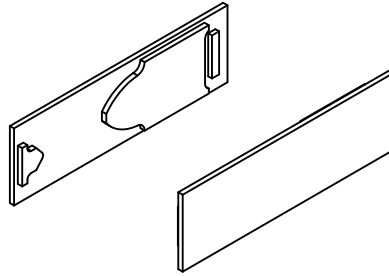

Included with the mCove System, end caps matching the fixture finish attach directly to the mCove Straight Extrusion

**C - LineLED**

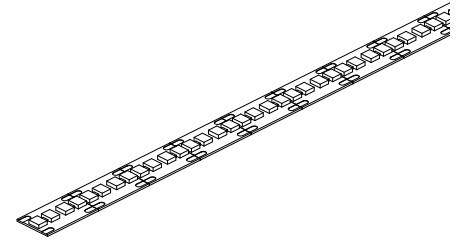

Included with MCove Rec System, the LineLED will be split into runs based on system layout and max run length of the LED strip. By default, the LineLED will come with soldered leads (SL) on end and no connector (NC) on the other. Additional configurations available upon request.

**D - MCove Rec Corner**

Based on ordered Run

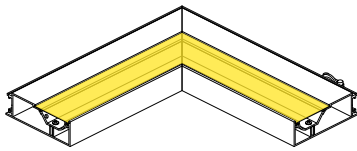

mCove Rec  
Inside Corner

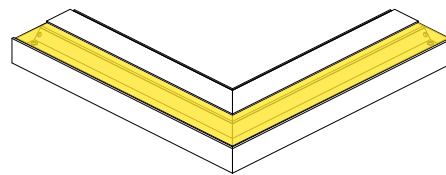

mCove Rec  
Outside Corner

Includes two welded mCove Rectangle extrusion pieces, two lenses, two mitered reflectors and a pair of joiners. Corners are nominally 12" x 12".

**MCove Rec System - Sample Run**

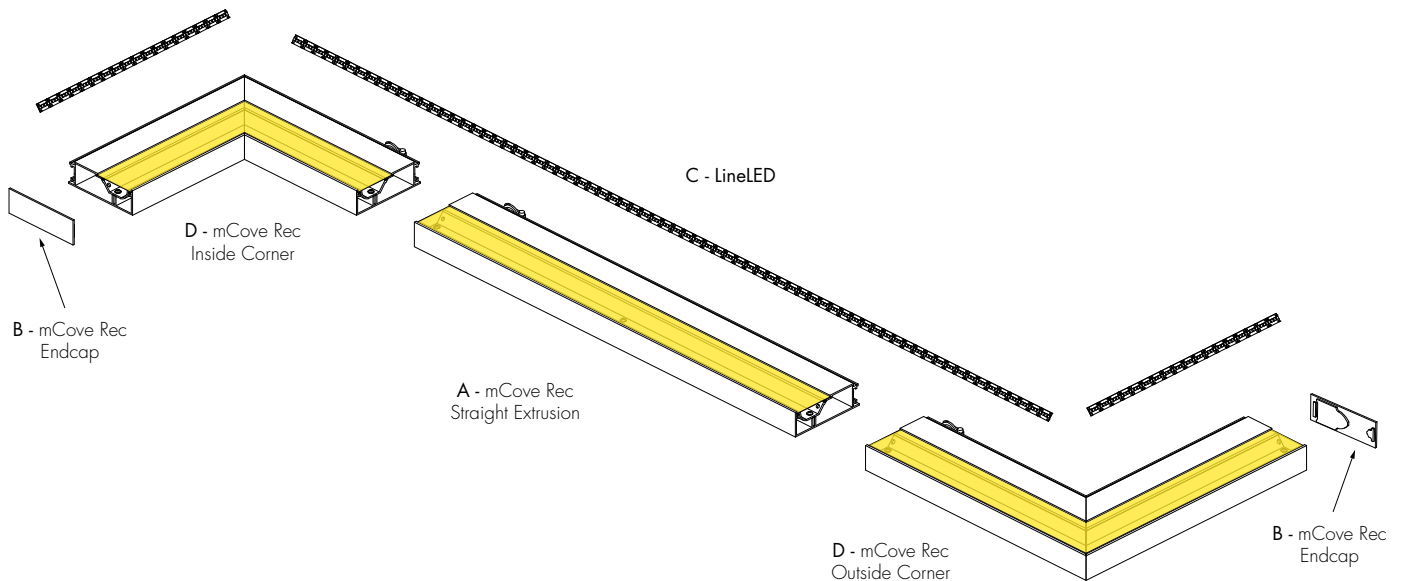

**Power Consumption**

Please visit the link/QR code below to access the Luminii Power Consumption Chart tool on our website.

There you will be able to select your fixture, output, and desired power feed to get a full power consumption table.



I'm also click-able

Desired Nominal Length: \_\_\_\_\_

Desired Output: \_\_\_\_\_

Desired CCT: \_\_\_\_\_

**Voltage Drop Calculator**

The below chart assumes nominal voltage of 24 Volts and a Voltage Drop Allowance of 3% through the wire

Wattage [W]	Maximum Wire Length From Power Supply to Start of Run [ft]						
	12 AWG	14 AWG	16 AWG	18 AWG	20 AWG	22 AWG	24 AWG
5	1088.2	684.4	430.3	270.6	170.2	107.1	67.3
10	544.1	342.2	215.1	135.3	85.1	53.5	33.7
15	362.7	228.1	143.4	90.2	56.7	35.7	22.4
20	272.0	171.1	107.6	67.7	42.6	26.8	16.8
25	217.6	136.9	86.1	54.1	34.0	21.4	13.5
30	181.4	114.1	71.7	45.1	28.4	17.8	11.2
35	155.5	97.8	61.5	38.7	24.3	15.3	9.6
40	136.0	85.5	53.8	33.8	21.3	13.4	8.4
45	120.9	76.0	47.8	30.1	18.9	11.9	7.5
50	108.8	68.4	43.0	27.1	17.0	10.7	6.7
55	98.9	62.2	39.1	24.6	15.5	9.7	6.1
60	90.7	57.0	35.9	22.6	14.2	8.9	5.6
65	83.7	52.6	33.1	20.8	13.1	8.2	5.2
70	77.7	48.9	30.7	19.3	12.2	7.6	4.8
75	72.5	45.6	28.7	18.0	11.3	7.1	4.5
80	68.0	42.8	26.9	16.9	10.6	6.7	4.2
85	64.0	40.3	25.3	15.9	10.0	6.3	4.0
90	60.5	38.0	23.9	15.0	9.5	5.9	3.7
96	56.7	35.6	22.4	14.1	8.9	5.6	3.5

## Power Supplies

See fixture and power supply instructions & spec sheet for wiring information. Dimming possible in select models - view Luminii website for list of compatible dimmers.

### For use with Warm Dim

#### Ordering Code - Universal Dimming Power Supplies 0.1% 120VAC - 277VAC

MODEL	INPUT CONTROL	WATTAGE	OUTPUT
PS-Power Supply, 120-277VAC	UNI - 0-10V Dimming (0.1%), Phase Dimming (0.1%)	30 - 30 Watts 60 - 60 Watts 96 - 96 Watts 3x96 - 3x96 Watts	24 - 24 VDC

Compatibility: View a complete list of compatible dimmers on the PS-UNI product page.

0-10V - 0.1% dimming  
MLV/ELV/TRIAC - 0.1% dimming, consult dimming compatibility chart

MODELS	PS-UNI-30W	PS-UNI-60W	PS-UNI-96W	PS-UNI-3X96W
<b>Length</b>	6.50"	7.40"	8.66"	11.85"
<b>Width</b>	3.73"	3.73"	3.73"	4.32"
<b>Depth</b>	1.61"	1.61"	1.61"	1.81"

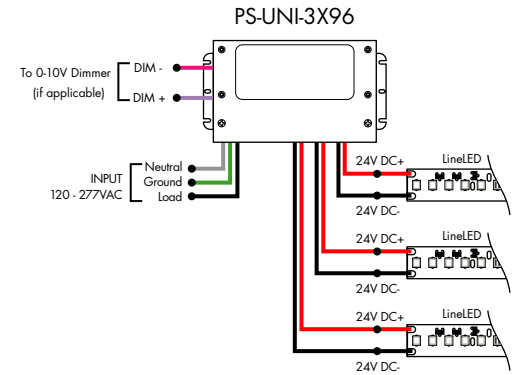
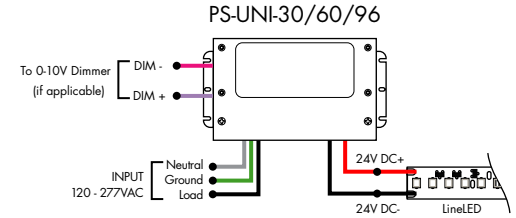

#### Ordering Code - DALI 2 Dimming Power Supplies 0.1% 120VAC - 277VAC

MODEL	INPUT CONTROL	ENVIRONMENT	WATTAGE	OUTPUT
PS-Power Supply, 120-277VAC	DALI2-DT6 - DALI2 DT6 (0.1%)	D - Dry	96-96 Watts	24 - 24 VDC

<b>Model</b>	<b>96W</b>
<b>Length</b>	14.40"
<b>Width</b>	5.20"
<b>Depth</b>	2.60"

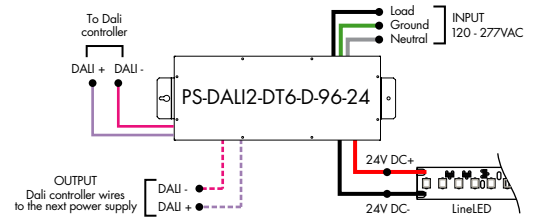

## Power Supplies

See fixture and power supply instructions & spec sheet for wiring information. Dimming possible in select models - view Luminii website for list of compatible dimmers.

### For use with Warm Dim

#### Ordering Code - 0-10V Dimming Power Supplies 0.1% 120VAC - 277VAC

MODEL	INPUT CONTROL	ENVIRONMENT	WATTAGE	OUTPUT
PS - Power Supply, 120-277VAC	010V-LIN - 0-10V Dimming (0.1%), Linear 010V-LOG - 0-10V Dimming (0.1%), Logarithmic	D - Dry	96-96 Watts 3x96-3x96 Watts	24-24 VDC

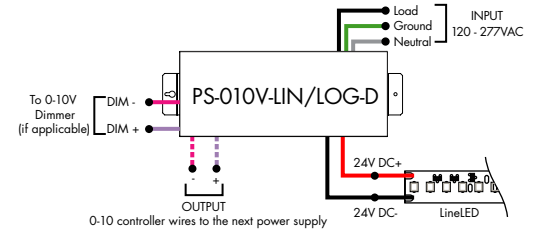

PS-010V-LIN/LOG-D-3X96

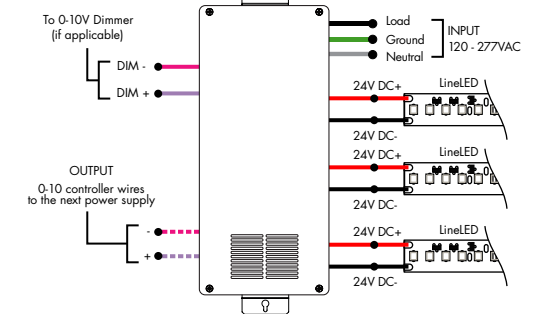

MODELS	96W	3X96
<b>Length</b>	14.40"	15.00"
<b>Width</b>	5.20"	6.62"
<b>Depth</b>	2.60"	4.45"

#### Ordering Code - Athena 0-10V LED Driver

MODEL	INPUT CONTROL	ENVIRONMENT	WATTAGE	OUTPUT	FEATURE
PS - Power Supply, 120-277VAC	010V-LIN - 0-10V Dimming (0.1%), Linear 010V-LOG - 0-10V Dimming (0.1%), Logarithmic	D - Dry	96-96 Watts	24-24 VDC	AWNR - Athena Wireless Node

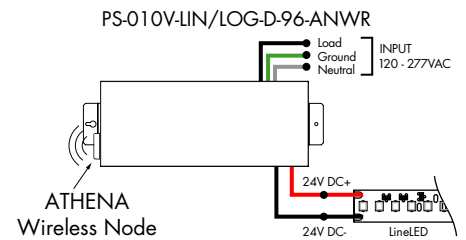

MODELS	96W
<b>Length</b>	14.40"
<b>Width</b>	5.20"
<b>Depth</b>	2.60"

## Power Supplies

See fixture and power supply instructions & spec sheet for wiring information. Dimming possible in select models - view Luminii website for list of compatible dimmers.

### For use with Tunable White

#### Ordering Code - DALI2 Dimming Power Supplies 0.1% 120VAC - 277VAC

MODEL	INPUT CONTROL	ENVIRONMENT	WATTAGE	OUTPUT
PS - Power Supply, 120-277VAC	DALI2-DT8 - DALI DT8 Tunable White (0.1%)	D - Dry	96 - 96 Watts	24 - 24 VDC

MODELS	96W
Length	14.40"
Width	5.20"
Depth	2.60"

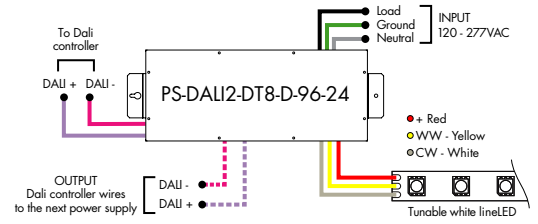

#### Ordering Code - Athena DALI2 Dimming Power Supplies 0.1% 120VAC - 277VAC

MODEL	INPUT CONTROL	ENVIRONMENT	WATTAGE	OUTPUT	FEATURE
PS - Power Supply, 120-277VAC	DALI2-DT8 - DALI DT8 Tunable White (0.1%)	D - Dry	96 - 96 Watts	24 - 24 VDC	AWN - Athena

MODELS	96W
Length	14.40"
Width	5.20"
Depth	2.60"

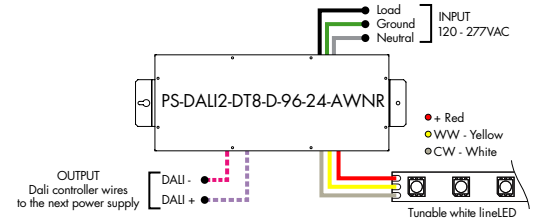

#### Ordering Code - DALI2 Dimming Power Supplies 0.1% 120VAC - 277VAC - for Dim-to-Warm functionality with Tunable White Output

MODEL	INPUT CONTROL	ENVIRONMENT	WATTAGE	OUTPUT
PS - Power Supply, 120-277VAC	DALI2-WD - DALI2 DT6 Warm Dim (0.1%)	D - Dry	96 - 96 Watts	24 - 24 VDC

MODELS	96W
Length	14.40"
Width	5.20"
Depth	2.60"

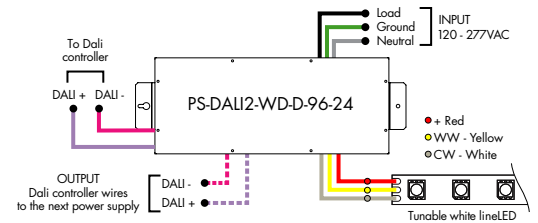

#### Ordering Code - DMX Dimming Power Supplies 0.1% 120VAC - 277VAC

MODEL	INPUT CONTROL	ENVIRONMENT	WATTAGE	OUTPUT
PS - Power Supply, 120-277VAC	DMX - DMX (0.1%)	D - Dry	96 - 96 Watts 3X96 - 3X96 Watts	24 - 24 VDC

MODELS	96W	3X96
Length	14.40"	15.00"
Width	5.20"	6.62"
Depth	2.60"	4.56"

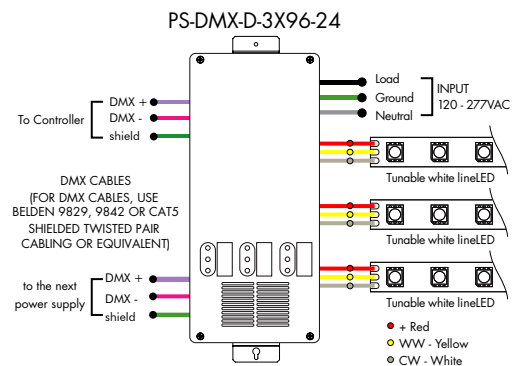
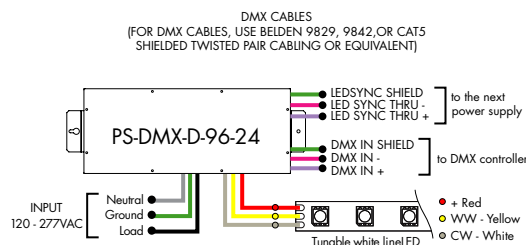

## Power Supplies

See fixture and power supply instructions & spec sheet for wiring information. Dimming possible in select models - view Luminii website for list of compatible dimmers.

### For use with Tunable White

#### Ordering Code - VintageDim® 0-10V Dimming Power Supplies 0.1% 120VAC - 277VAC

MODEL	INPUT CONTROL	ENVIRONMENT	WATTAGE	OUTPUT
PS - Power Supply, 120-277VAC	010V-WD - 0-10V Dimming (0.1%), Standard Warm Dim Curve (with Tunable White LED) 010V-TW - 0-10V Dimming (0.1%), Two Channel Control, Brightness and CCT1-CCT2 Ratio 010V-2CH - 0-10V Dimming (0.1%), Two Channel Control, LED1 Brightness and LED2 Brightness 010V-WDX - 0-10V Dimming (0.1%), Customizable Warm Dim Curve (with Tunable White LED)	D-Dry	96-96 Watts 3X96 - 3x96 Watts <sup>1</sup>	24-24 VDC

1 - 3x96 is only available with input control options 010V-WD and 010V-TW

MODELS	96W	3X96
<b>Length</b>	14.40"	15.00"
<b>Width</b>	5.20"	6.62"
<b>Depth</b>	2.60"	4.56"

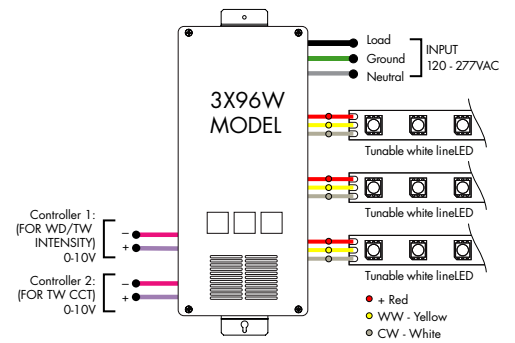
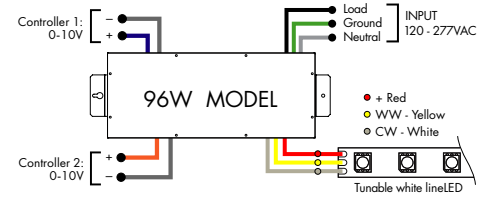

#### Ordering Code - Athena VintageDim® 0-10V Power Supply 0.1% 120VAC - 277VAC - for Dim-to-Warm functionality with Tunable White Output

MODEL	INPUT CONTROL	ENVIRONMENT	WATTAGE	OUTPUT	FEATURE
PS - Power Supply, 120-277VAC	010V-WD - 0-10V Dimming, Standard Warm Dim Curve (with Tunable White LED)	D-Dry	96-96 W	24-24 VDC	AWN - Athena

MODELS	96W
<b>Length</b>	14.40"
<b>Width</b>	5.20"
<b>Depth</b>	2.60"

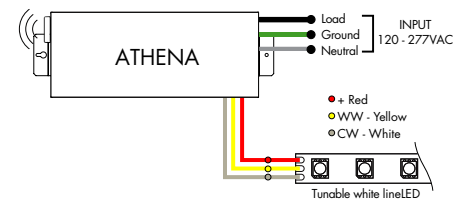

#### Ordering Code - Athena VintageDim® 0-10V Two Channel LED Driver, 0.1% 120VAC - 277VAC

MODEL	INPUT CONTROL	ENVIRONMENT	WATTAGE	OUTPUT	FEATURE
PS - Power Supply, 120-277VAC	010V-2CH - 0-10V Dimming Two Channel Control, LED1 Brightness and LED2 Brightness	D-Dry	96-96 W	24-24 VDC	AWN - Athena

MODELS	96W
<b>Length</b>	14.40"
<b>Width</b>	5.20"
<b>Depth</b>	2.60"

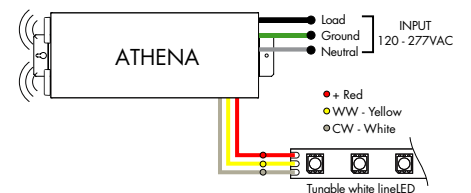

### Power Supplies

See fixture and power supply instructions & spec sheet for wiring information. Dimming possible in select models - view Luminii website for list of compatible dimmers.

#### For use with RGB/RGBW

#### Ordering Code - Universal Dimming Power Supplies 0.1% 120VAC - 277VAC

MODEL	INPUT CONTROL	WATTAGE	OUTPUT
PS - Power Supply, 120-277VAC	UNI - 0-10V Dimming (0.1%), Phase Dimming (0.1%)	30 - 30 Watts 60 - 60 Watts 96 - 96 Watts 3x96 - 3x96 Watts	24 - 24 VDC

MODELS	PS-UNI-30W	PS-UNI-60W	PS-UNI-96W	PS-UNI-3X96W
<b>Length</b>	6.50"	7.40"	8.66"	11.85"
<b>Width</b>	3.73"	3.73"	3.73"	4.32"
<b>Depth</b>	1.61"	1.61"	1.61"	1.81"

REQUIRES A CONTROLLER AND A DECODER TO WORK PROPERLY

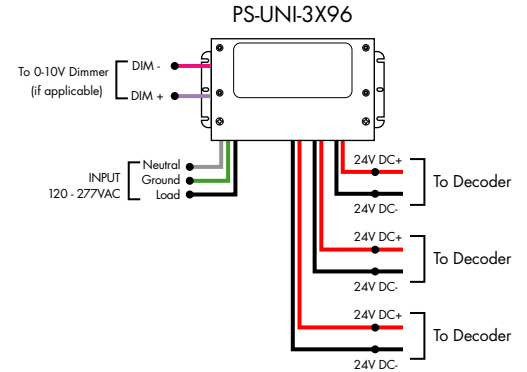
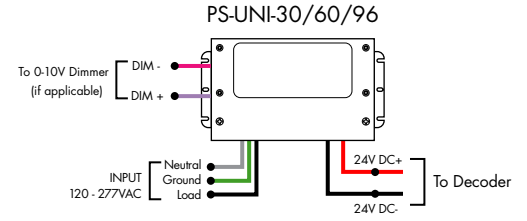

#### For use with RGB/RGBW

#### Ordering Code - DMX Dimming Power Supplies 0.1% 120VAC - 277VAC

MODEL	INPUT CONTROL	ENVIRONMENT	WATTAGE	OUTPUT
PS - Power Supply, 120-277VAC	DMX - DMX (0.1%)	D - Dry	96 - 96 Watts 3X96 - 3X96 Watts	24 - 24 VDC

MODELS	96W	3X96
<b>Length</b>	14.40"	15.00"
<b>Width</b>	5.20"	6.62"
<b>Depth</b>	2.60"	4.56"

DMX CABLES (FOR DMX CABLES, USE BELDEN 9829, 9842 OR CAT5 SHIELDED TWISTED PAIR CABLING OR EQUIVALENT)

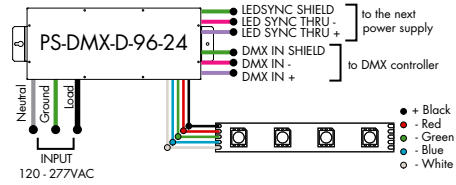

PS-DMX-D-3X96-24

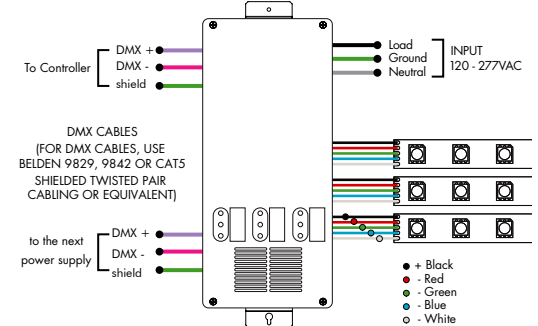

#### For use with RGB/RGBW/Pixel

#### Ordering Code - Non-Dimming Power Supply 120VAC - 277VAC

MODEL	INPUT CONTROL	ENVIRONMENT	WATTAGE	OUTPUT
PS - PSV Series	ND - Non Dimming	D - Dry	96 - 96 Watts	24 - 24 VDC

MODELS	96W
<b>Length</b>	14.40"
<b>Width</b>	5.20"
<b>Depth</b>	2.60"

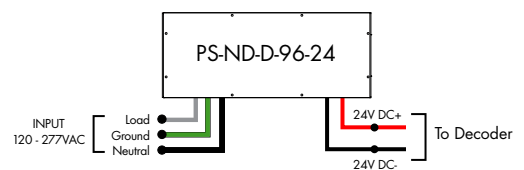

REQUIRES A CONTROLLER AND A DECODER TO WORK PROPERLY

**Controllers and Decoders**

**For use with Tunable White Power Supplies**



ORDERING CODE

MODEL

**DTW-MC**

DTW-MC - Tunable White controller

Tunable White wall-mount controller controls lighting fixtures, wireless control of TW lighting fixture. Fits in any standard US switch box. Includes all the outputs in the back of the controller.

**Features**

- Switch & dimming control function, control range > 20M.
- Smooth transition between light levels.
- Separately operate dimming and color temperature functions.
- Able to control 1 zone with endless receivers. Each receiver can maximally be controlled by 8 remotes.
- Power, temperature color and dimming functions operated by push button after receivers are connected.

**Operating Voltage**

3V DC battery

**Color Parameters**

- Brightness
- Saturation
- Fading



ORDERING CODE

MODEL

**TW-DMX**

TW-DMX - DMX controller

Tunable White DMX wall-mount controller is a fully touch sensitive controller designed in accordance with standard dimming protocol DMX512. Offers fast and accurate color temperature adjustment and brightness dimming of natural white, warm white and cold white. Designed with a touch color wheel, the DMX512 controller can adjust color temperature and brightness for all white LEDs smoothly and accurately. The DMX controller can control 1 zone with endless decoders.

**Features**

- 1 zone
- 6 color scenes
- DMX Control
- Touch Sensitive Glass Surface
- Dimming and Speed Control
- Memory Function
- Easily Fits Standard US Switch Boxes

**Operating Voltage**

12 - 24V DC

**Color Parameters**

- Brightness
- Saturation
- Primary colors
- Fading
- Color changing speed



ORDERING CODE

MODEL

**SLD-DIMTW**

SLD-DIMTW - Tunable white LED dimming module

The SLD DimTW is a constant voltage warm dimming LED dimming module. The unique dimming module accepts 0-10V control and mimics a smooth, incandescent dimming curve.

**Features**

- Flicker free 0-100% dimming
- High efficiency up to 97%
- High precision dimming ratio:>1:1000
- Fully isolated plastic housing
- Comply with EN55015 and FCC part 15 without additional input filter and capacitors
- compact size, high reliability
- 3 years warranty

**Operating Voltage**

8-48 VDC

**Controllers and Decoders**

**For use with Tunable White, RGB/RGBW Power Supplies**



Translates controller DMX512 programs for RGB and white LED strips.

Unique DMX address for the decoder can be set easily and displayed by the numeric display on the case. Changing and resetting the DMX address requires manual input.

Use power repeater to expand output.

**Operating Voltage**

12-36 VDC

**Power Capacity**

up to 96W at 24V

**Operating Temperature Range**

from -4°F to +122°F in case

ORDERING CODE

MODEL

**DDMX-RGBW**

DDMX-RGBW - DMX decoder



The RGBW receiver is easily paired with controller by the click of a button. Receiver can be reset to factory settings at any time.

Each receiver can store one static RGB color, one color sequence, and one brightness setting for the white LED strip. Receivers assigned to the same scene within the same zone will have the same LED static color and color sequence.

**Operating Voltage**

12-36 VDC

**Power Capacity**

up to 96W at 24V

**Operating Temperature Range**

from -4°F to +122°F in case

ORDERING CODE

MODEL

**RGBW-RC-R**

RGBW-RC-R - RGBW receiver



Extends identical signal when connected in series to an RGBW LED control system. The RGBW signal repeater works with Luminii RGB and RGBW controllers, receivers, and decoders.

RGBW signal can be extended indefinitely when adequate power supply (not included) is connected to the system.

**Operating Voltage**

12-36 VDC

**Power Capacity**

up to 96W at 24V

**Operating Temperature Range**

from -4°F to +122°F in case

ORDERING CODE

MODEL

**RGBW-SR**

RGBW-SR - RGBW signal repeater

**Controllers and Decoders**

**For use with RGB/RGBW Power Supplies**



ORDERING CODE

MODEL

**RGBW-MC3**

RGBW-MC3 - 4-zone RGBW controller

Easy to operate wireless interface suitable for static or color changing scenes. Control 4 different color zones separately or at the same time. RGBW receiver (RGBW-RC-R) required for operation. Assign multiple receivers per zone to cover a large area.

Color wheel enables highly stable and sensitive color control functionality. Create your own color changing sequences with ease and flexibility.

**Power**

qty 3 AAA batteries

**Scenes**

up to 4 unique zones

**Signal**

Wireless (RF)

**Energy Saving**

Deactivates after 10 seconds of inactivity

**Color Parameters**

- Brightness
- Saturation
- Primary colors
- Speed of color changing sequence
- Fading

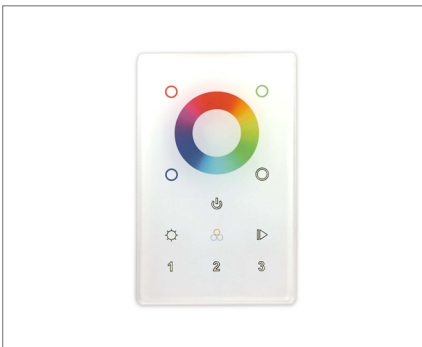

ORDERING CODE

MODEL

ZONES

COLOR

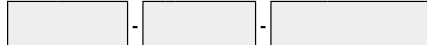

DMX-DMX Controller - 3Z-Three Zone 1Z-One Zone RGBW-Red,Green,Blue,& White

DMX /Wireless RGB-W wall-mount controller controls DMX lighting fixtures, wireless control of RGB-W lighting fixture or use both simultaneously. Fits in any standard US switch box. Includes all the outputs in the back of the controller.

Control brightness levels with a single touch, personalize and memorize 3 different scenes, and even create 3 variations of white.

**Features**

- 2 in 1 in-Wall Controller: DMX Control or Wireless RGB-W
- 65,000 Color Options, Dimming and Speed Control
- Memory Function
- 50 Foot Wireless Range
- Easily Fits Standard US Switch Boxes
- Touch Sensitive Glass Surface
- Includes 10 Built in Programs, or Create and Play Your Own

**Operating Voltage**

12 - 24V DC

**Color Parameters**

- Brightness
- Saturation
- Primary colors
- Fading
- Color changing speed

**For use with Tunable White, RGB/RGBW, Pixel Power Supplies**

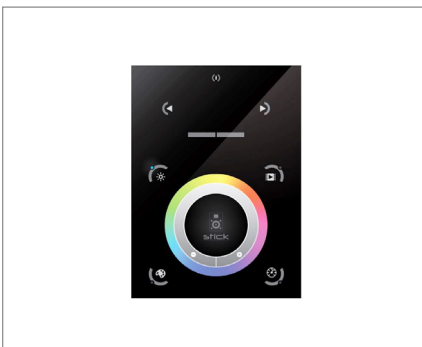

ORDERING CODE

MODEL

**TSDMX-E**

TSDMX-E - Touchscreen DMX controller

Programmable advanced DMX512 lighting controller featuring a touch-screen interface. Operates as stand alone controller or integrated with most architectural lighting control systems. Can controller endless DMX512 enabled devices.

Mounts to standard single or dual gang wall box with the included power supply inside the junction box. Terminal block design for power and data connections.

**Features**

- Sleek glass design which sits 0.43" from the wall
- Graphical color display to show selected environment
- Color/dimmer/speed palette
- Color temperature mixing
- Touch sensitive buttons. No mechanical parts
- Touch sensitive wheel allows for accurate color selection
- Multi-zone microSD memory
- Multi-room control with 500 scenes, 10 zones
- 1024 DMX channels. Control 340 RGB fixtures
- USB & Ethernet connectivity for programming and control

**Power Supply**

7 VDC (included)

**Programmability**

PC, Mac, Tablet, Smartphone

**Output Signal**

DMX512 (1024 channels)

**Color Parameters**

- Brightness
- Saturation
- Speed of color changing sequence
- Fading / dimming / brightness

**Controllers and Decoders**

**For use with Tunable White, RGB/RGBW Power Supplies**

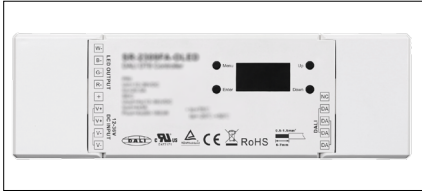

ORDERING CODE

MODEL

**DALI2-DT8-RGBW**

DALI2-DT8-RGBW - DALI-2 RGBW Decoder

A 4-channel DALI2 DT8 decoder designed to control RGB, RGBW, and TW LED fixtures, featuring adjustable color temperature and customizable lumen output.

**Voltage/Frequency**  
12-36VDC

**Max Output Power**  
4 output channels, 60-180W each

**Max Output Current**  
4 output channels, max of 5A each

**Ambient Operating Temperature Range**  
-20 to 50 °C

**Environment**  
Dry (IP20)



ORDERING CODE

MODEL

**DDMX-5CH-RDM-PRO**

DDMX-5CH-RDM-PRO - DMX512 Decoder

DMX512 decoder with RDM functionality features 5 PWM output channels with common anode. High PWM output frequency range allows the product to be used in HD video conferencing spaces. All DMX products to be installed per DMX512 Standard.

**Power**

96 Watt

**Inputs**

RJ45, XLR-5Pin, Terminal Block

**DMX Channels**

1 to 5 settable

**PWM Output Resolution Ratio**

8 or 16 bit

**PWM Output Frequency**

500Hz - 30KHz

**Output Dimming Curve Gamma Value**

0.1 ~ 9.9



ORDERING CODE

MODEL

**RGBW-WI-R**

RGBW-WI-R - WIFI generator

RGBW-WI-R creates a local network that enables any electronic device (phone, tablet, etc.) to control the RGB/W strip connected to a RGBW-RC-R receiver.

The control functions are achieved through a free application download for Android and iOS devices called REALCOLOR.

**Operating Voltage**

12-36 VDC

**Power Supply**

PI-130-24 (included)

**Operating Temperature Range**

from -4°F to +122°F in case

**For use with Pixel Power Supplies**

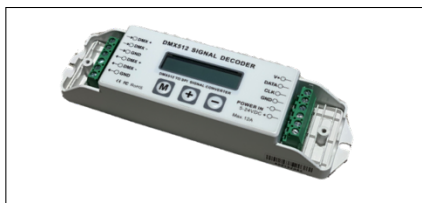

ORDERING CODE

MODEL

**SR-DMX-SPI**

SR-DMX-SPI - Smart Pixel Decoder

The SR-DMX-SPI is a smart LED pixel decoder that controls RGB/RGBW pixel LED strips with SPI signal. Designed with an OLED backlit panel, the pixel controller allows for easy configuration of most settings. Four push buttons are available for control of the LED functions.

\*For pixel only.

**Features**

- 2 in 1 in-Wall Controller: DMX Control or Wireless RGB-W
- SPI signal output for RGB/RGBW pixel light control
- DMX512 controllable and RF/WIFI remote controllable
- Capable of addressing up to 1020 RGB pixels & 765 RGBW pixels
- OLED panel allows for easy configuration

**Operating Voltage**

12 - 36V DC

**Power capacity**

up to 96W at 24V

**Operating temperature range**

from -4°F to +122°F in case