

mCove Rectangle Low Voltage - Installation Instructions

Models M-REC-XX

Please read all instructions prior to installation and keep for future reference!

1. PRODUCT TO BE INSTALLED BY A QUALIFIED ELECTRICIAN.
2. USE ONLY WITH CLASS 2 POWER UNIT.
3. 24 VOLTS DC.
4. SUITABLE FOR DAMP LOCATIONS.
5. UNDER-CABINET OR SURFACE MOUNT.

PLENUM FOR
SUCH USE IN
ACCORDANCE
WITH UL2043



REVO.1
01272026

1 / 5



7777 Merrimac Ave
Niles, IL 60714
T 224.333.6033
F 224.757.7557
info@luminii.com
www.luminii.com

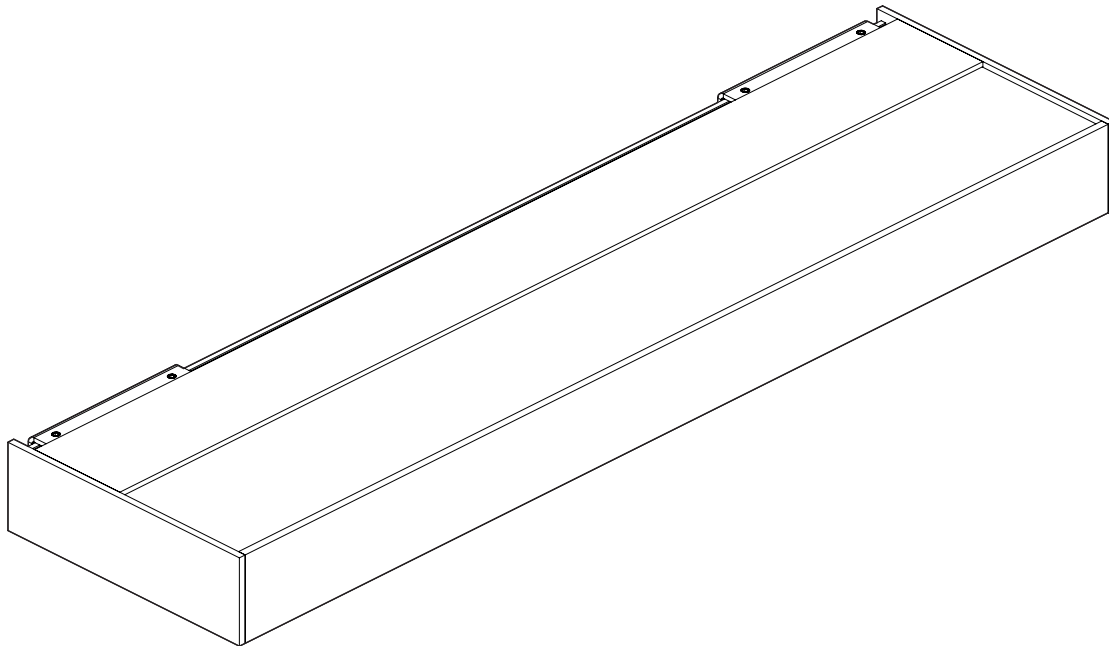

mCove Rectangle Low Voltage - Installation Instructions

Models M-REC-XX

Please read all instructions prior to installation and keep for future reference!

1. PRODUCT TO BE INSTALLED BY A QUALIFIED ELECTRICIAN. 5. UNDER-CABINET OR SURFACE MOUNT.
2. USE ONLY WITH CLASS 2 POWER UNIT.
3. 24 VOLTS DC.
4. SUITABLE FOR DAMP LOCATIONS.



7777 Merrimac Ave
Niles, IL 60714
T 224.333.6033
F 224.757.7557
info@luminii.com
www.luminii.com

PLENUM FOR SUCH USE IN ACCORDANCE WITH UL2043

REVO.1
01272026

2 / 5

1

1.1 cover →

1.2 screw →

fixture →

1.2

fixture →

1.3

fixture →

1.1 From the inside of the fixture, carefully insert a flathead screwdriver to the edge. Followed by carefully pulling on the cover to remove.

1.2 Loosen & remove all the screws from the center of the reflector.

1.3 Carefully, rotate and pull the reflector completely out.

2

BACK OF FIXTURE

2.1

NOTE: Prior to installing the fixture, power wires must be present near fixture installation.

NOTE: Mounting bracket quantities vary depending on size. Typically 1 bracket per every 30". If joining as a system, make sure to use a bracket inbetween fixtures to align to each other.

2.2

3

3.1

mark →

anchor →

anchor →

Phillips screwdriver →

3.2

mCove Rectangle Low Voltage - Installation Instructions

Models M-REC-XX



7777 Merrimac Ave
Niles, IL 60714
T 224.333.6033
F 224.757.7557
info@luminii.com
www.luminii.com

Please read all instructions prior to installation and keep for future reference!

1. PRODUCT TO BE INSTALLED BY A QUALIFIED ELECTRICIAN.
2. USE ONLY WITH CLASS 2 POWER UNIT.
3. 24 VOLTS DC.
4. SUITABLE FOR DAMP LOCATIONS.
5. UNDER-CABINET OR SURFACE MOUNT.

PLENUM FOR SUCH USE IN ACCORDANCE WITH UL2043

REVO.1
01272026

3 / 5

4

set screw
mounting bracket
fixture

4.1

4.1 Bring in the power wires into the fixture. Align the fixture to the mounting brackets and secure in place using the 2 set screws for each mounting bracket. Use the provided conduit connector if necessary, in accordance with local electrical codes.

5

reflector/LED
fixture

5.1

5.1 While holding the LED reflector connect the red & black wires to the power supply red (24VDC+) & black (24VDC-) wires. For additional wiring information refer to the power supply instruction.

5.2 Insert the LED panel into the fixture and secure using the provided screws. Snap-in the cover in the fixture (cover will fit loose inside the fixture).

cover
screw

5.1

Mask (not provided)

OPTIONAL IF PAINTING:
Mask and or cover the fixture by following the diagram above in highlighted area. To avoid any paint from entering the inside of the fixture.

mCove Rectangle Low Voltage - Installation Instructions

Models M-REC-XX

Please read all instructions prior to installation and keep for future reference!

1. PRODUCT TO BE INSTALLED BY A QUALIFIED ELECTRICIAN.
2. USE ONLY WITH CLASS 2 POWER UNIT.
3. 24 VOLTS DC.
4. SUITABLE FOR DAMP LOCATIONS.
5. UNDER-CABINET OR SURFACE MOUNT.



7777 Merrimac Ave
Niles, IL 60714
T 224.333.6033
F 224.757.7557
info@luminii.com
www.luminii.com

PLENUM FOR SUCH USE IN ACCORDANCE WITH UL2043

REVO.1
01272026

4 / 5

System wiring guide

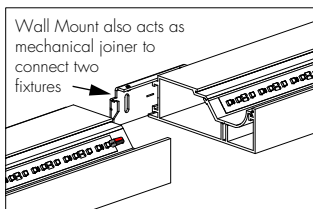
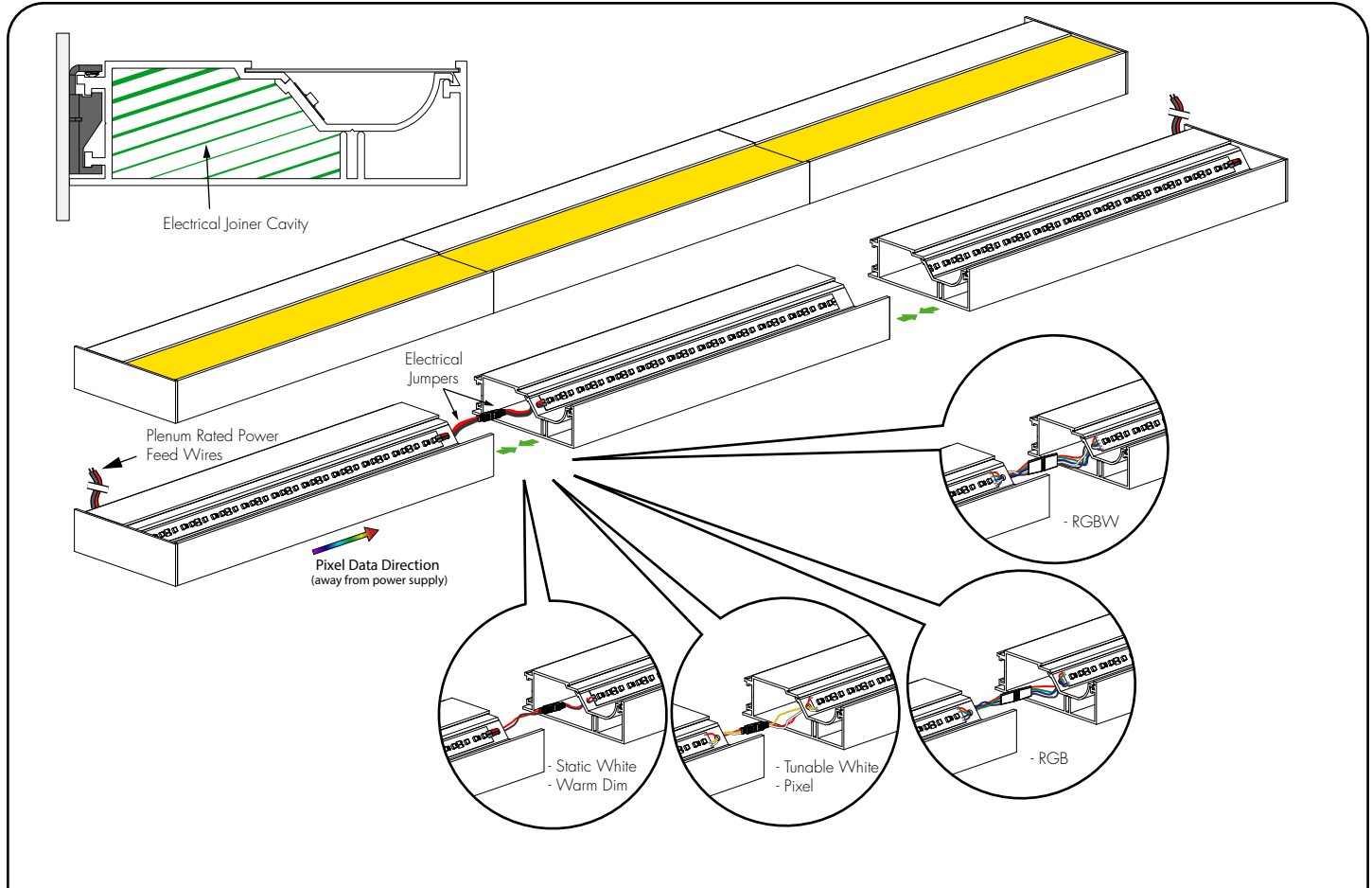

IF CONNECTING MULTIPLE FIXTURES TOGETHER:
The mounting bracket also acts as a joiner/aligner between multiple fixtures. Slide one of the mounting brackets to span across both fixtures, then secure by tightening the set screws on the mounting bracket.

Wall Mount also acts as mechanical joiner to connect two fixtures

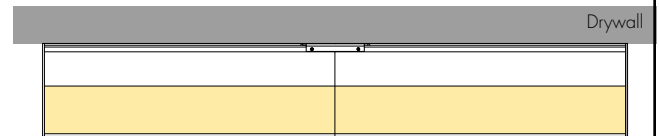
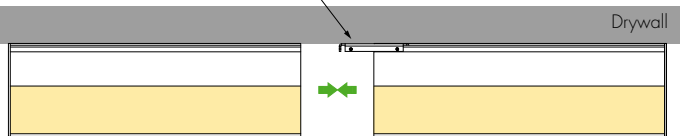

mCove Rectangle Low Voltage - Installation Instructions

Models M-REC-XX

Please read all instructions prior to installation and keep for future reference!

1. PRODUCT TO BE INSTALLED BY A QUALIFIED ELECTRICIAN.
2. USE ONLY WITH CLASS 2 POWER UNIT.
3. 24 VOLTS DC.
4. SUITABLE FOR DAMP LOCATIONS.
5. UNDER-CABINET OR SURFACE MOUNT.

PLENUM FOR
SUCH USE IN
ACCORDANCE
WITH UL2043



REVO.1
01272026

5 / 5



7777 Merrimac Ave
Niles, IL 60714
T 224.333.6033
F 224.757.7557
info@luminii.com
www.luminii.com

Power Supply Wiring Diagram

Note: Prior to installation all 24VDC wires must be present near fixture. Refer to the power supply installation instructions for additional information.

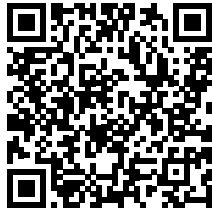

Static White
[Wiring Diagram PDF](#)

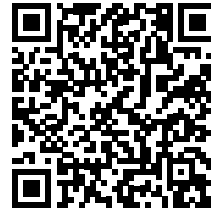

RGB/RGBW
[Wiring Diagram PDF](#)



Warm Dim
[Wiring Diagram PDF](#)

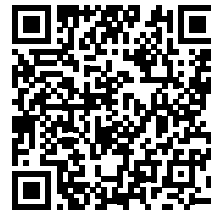

Pixel
[Wiring Diagram PDF](#)



Tunable White
[Wiring Diagram PDF](#)