

Features

- Full length seamless lenses range from 2 to 12 feet.
- Trimless design meant to blend directly into the environment
- Not limited to straight runs, available in L nodes, providing freedom to create seamless configurations, available in 22.5in increments.
- Integrated drivers and controls make this fixture easy to install and widely applicable
- The Vesta Recessed line features a powerful light in a clean, recessed format while not sacrificing the symmetrical, high-performance frosted lens which illuminates the surface evenly with no shadows or dark spots.
- Five Year Warranty.



Finish Options



Technical Information

OUTPUT OPTIONS (Frosted Lens)	04	06	08	10	12
Lumen Output	400 lm/ft	566 lm/ft	843 lm/ft	1034 lm/ft	1220 lm/ft
Average Power Consumption	3.8 W/ft	5.7 W/ft	9.4 W/ft	12.0 W/ft	15.1 W/ft
Efficacy	104 lm/W	100 lm/W	90 lm/W	87 lm/W	81 lm/W

CCT	Multiplier	CRI	TM-30		
			R _f	R _g	R ₉
2700K	0.92	93+	92	100	50+
3000K	0.97	93+	92	103	50+
3500K	1.00	93+	93	102	50+
4000K	1.07	93+	92	101	50+

OUTPUT OPTIONS (Asymmetric Lens)	04	06	08
Lumen Output	433 lm/ft	648 lm/ft	800 lm/ft
Average Power Consumption	8.1 W/ft	13.8 W/ft	17.3 W/ft
Efficacy	54 lm/W	47 lm/W	46 lm/W

Ordering Code

Integral Driver Example: Fixture VSD-L-6ft-06-35K-F-AF5-WH-010S-CSMB

Fixture

MODEL	LENGTH	OUTPUT DOWN	CCT	LENS DOWN
VSD-L - Vesta Dry, Recessed Trimless	2ft - 2 feet 4ft - 4 feet 6ft - 6 feet 8ft - 8 feet 10ft - 10 feet 12ft - 12 feet XX - System ¹²	04 - 400 lm/ft (3.8 W/ft) 06 - 566 lm/ft (5.7 W/ft) 08 - 843 lm/ft (9.4 W/ft) 10 - 1034 lm/ft (12 W/ft) 12 - 1220lm/ft (15W/ft)	27K - 2700K 30K - 3000K 35K - 3500K 40K - 4000K	F - Frosted Lens AS - Asymmetric Lens ^{1,2,3} BL - Black Lens

MOUNTING	FINISH	DRIVER	DRIVER OPTIONS
GS - Gypsum Surface Mounting Bracket AF5 - AC + Feed Cable, 5ft long AF8 - AC + Feed Cable, 8ft long AF10 - AC + Feed Cable, 10ft long	WH - White BK - Black SL - Silver	010S - 010V, 1% Dimming, 120V/277V 0103 - 010V, 1% Dimming, 347V Only ⁴ 010L - EldoLED, 010V, Linear, 0.1% Dimming, 120V/277V ⁵ 010G - EldoLED, 010V, Log, 0.1% Dimming, 120V/277V ⁵ DALI - EldoLED, DALI protocol 2, DF-6, Log, 0.1% Dimming, 120V/277V ⁵ LUTE - Lutron Hilume Ecodigital, 1% Dimming, 120V/277V ⁶ DMX - EldoLED, DMX, 0.1% Dimming, 120V/277V ⁵	NA - None EMG - Emergency Driver ^{7,8} CSMB - Casambi ⁹ AWN - Athena ¹⁰ MNOD - PIR Motion Sensor, Occupancy, Daylight Harvesting ¹¹

1 - Asymmetric lens not compatible with 2ft Length.
2 - Asymmetric lens is not compatible with 10 or 12 output.
3 - Asymmetric lens not compatible with 010L/010G/DALI/LUTE/DMX
4 - 0103 Driver (347V) not available with 2ft Length.
5 - OUTPUT 12 Not available for Drivers 010L/010G/DALI/DMX.
6 - OUTPUT 08/10/12 not available for LUTE driver.

7 - EMG Battery Back-Up not available on Length 2ft, 4ft or 6ft, illuminates 4ft or 6ft section based on lumen output.
8 - EMG not available with 0103/LUTE/DMX drivers.
9 - CSMB with 010S/010L/010G/DALI drivers only.
10 - AWNR contact manufacture for build assistance - (MOD Only).
11 - MNOD contact manufacturer for build assistance - (MOD Only).
12 - Customizable configurations available, contact factory (MOD only).

CONTACT FACTORY FOR MORE OPTIONS.

Dimensions

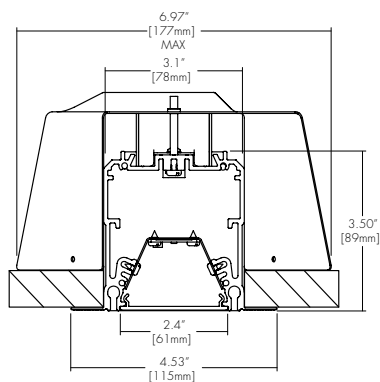

Lens

F
Frosted Lens



AS
Asymmetric Lens



BL
Black Lens

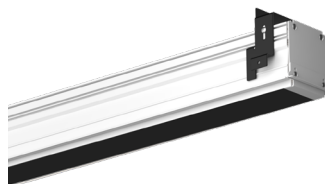

Cut Lengths

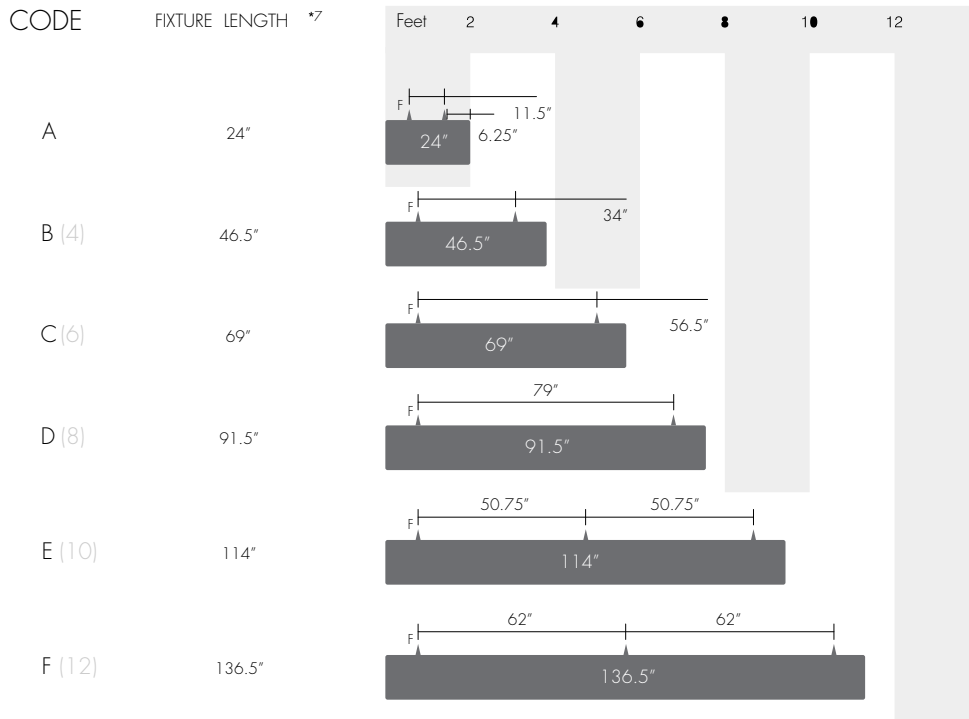

Legend

- ▲ : Mounting Point
- F : Feed Point

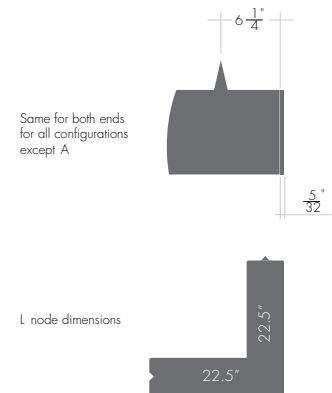

*7 Not including end-caps. End-caps are an additional 5/32"

*8 For custom lengths please customer service. Cover plates will be added to each end to avoid dark spaces on lense.

Standard Finish

BK
Black

WH
White

SL
Silver

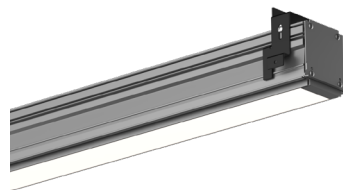
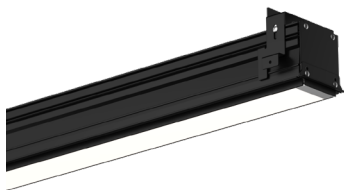

TM-30

2700K

COLOR VECTOR GRAPHIC

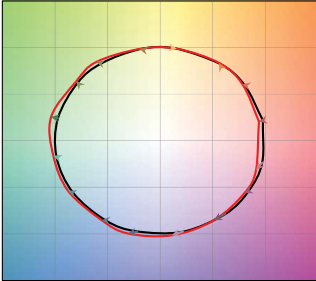

— Reference Source — Test Source

3000K

COLOR VECTOR GRAPHIC

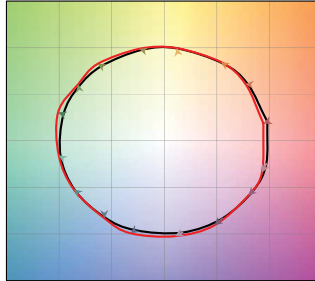

— Reference Source — Test Source

3500K

COLOR VECTOR GRAPHIC

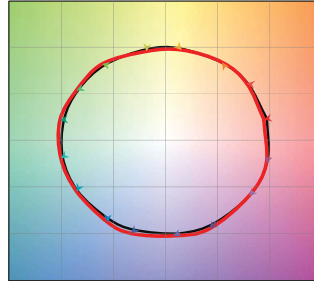

— Reference Source — Test Source

4000K

COLOR VECTOR GRAPHIC

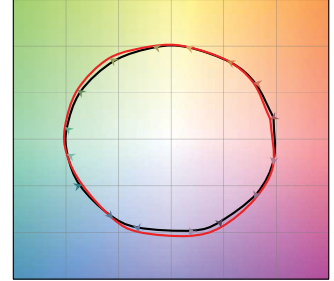

— Reference Source — Test Source

Photometry

Static White Down Frosted Lens

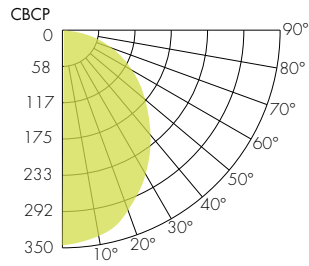
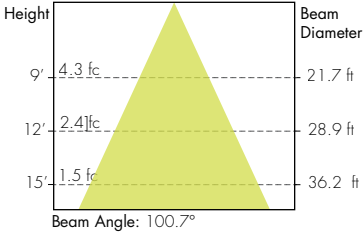

Static White Down Asymmetric Lens

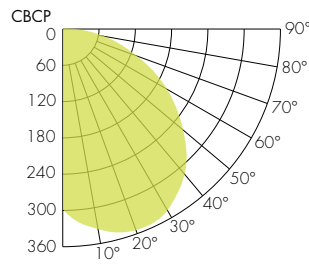
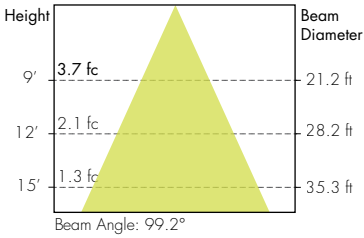

Static White Black Lens

