

# Plexineon Recessed Mount

RGB, RGBW and RGBW Pixel

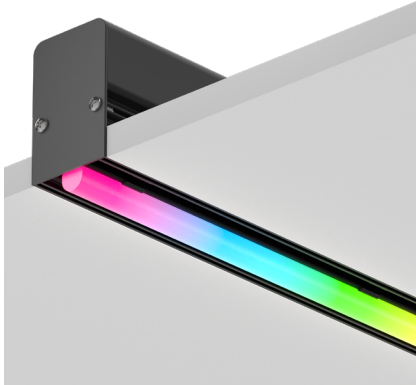

- For interior accent lighting.
- Neon look providing a crisp, clear line of light visible for miles
- Mounting Clips are included in the appropriate quantities
- Operating Temperature: -40° F to 140° F (-40° C to 60° C)
- 24VDC Class 2
- IK10 and 3G rated
- 5 year warranty

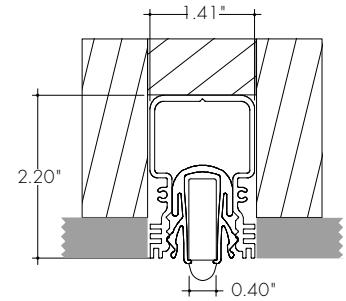

In Recessed Extrusion



## Technical Information

MODEL	Plexineon RGB	Plexineon RGBW	Plexineon Pixel RGBW
<b>OUTPUT OPTIONS</b>	SO		
<b>Lumens Output</b> <small>(all channels full on)</small>	72 lm/ft	110 lm/ft	84 lm/ft
<b>Average Power Consumption</b> <small>(for a 4' section)</small>	4.1 W/ft	5.4 W/ft	5.7 W/ft
<b>Efficacy</b>	17.5 lm/W	20.3 lm/W	14.7 lm/W
<b>Order Increment</b>	1.97"	3.94"	3.94"
<b>Max Run Length</b> <small>(in series)</small>	32 ft	17 ft	16 ft
<b>SPI Protocol</b>	N/A	N/A	UCS 2904
<b>DMX Addresses Occupied</b>	N/A	N/A	4-channels per pixel

RGBW (3000K)				
Model	TM-30			
	CRI	R <sub>f</sub>	R <sub>g</sub>	R <sub>g</sub>
RGBW	85	84	98	22
RGBW-PXSPI	85	84	98	22

Dominant Wavelength	
Color	RGB
Red	622nm
Green	525nm
Blue	468nm

## Ordering Code

MODEL	RUN LENGTH <sup>1</sup>	BEND	CCT	OUTPUT	LENS	MOUNTING <sup>2</sup>	FINISH	POWERFEED POSITION/TYPE
PX-Plexineon	____ -Run length in inches, 6" min, no max run length	SR-Straight Run	RGB-RGB RGBW-RGBW (3000K) RGBW-PXSPI-RGBW Pixel Control (3000K)	SO-Standard	F-Frosted	RM-Recessed Mount	BK-Matte Black	B-4-Male Quick Connect One End, Female Quick Connect Other End

1. RGB is available in 2" (1.97") order increments. RGBW and Pixel RGBW are available in 4" (3.94"), +/- 1/2" tolerance. Run Lengths over 96" (8ft) will be made of equal sections no longer than 96".  
 2. Recessed Mount includes all necessary hardware for either mud-in or hard ceiling (stone, marble) installation. Blocking above ceiling built by others.

# Plexineon Recessed Mount

RGB, RGBW and RGBW Pixel



## Installation Configurations

- Position of Plexineon fixtures within Extrusion Housing is adjustable in the field at time of install.

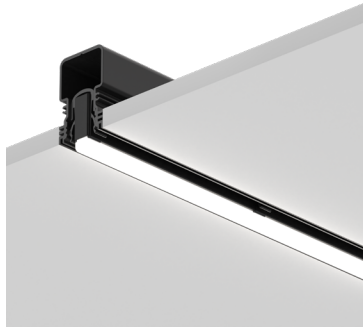

Exposed

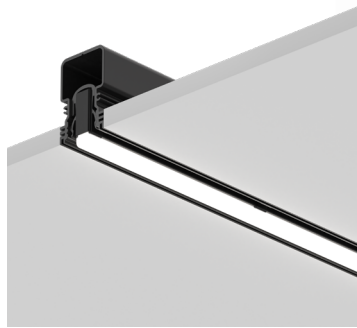
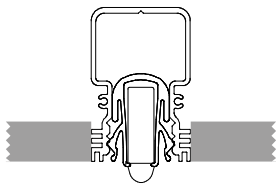

Semi-Recessed

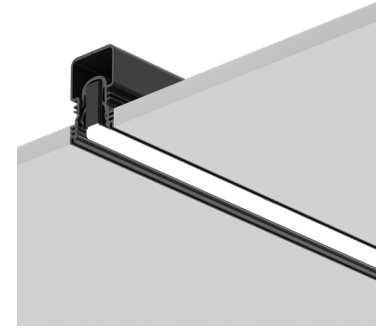
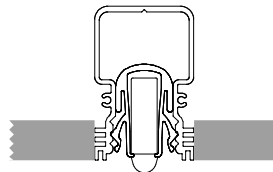

Fully Recessed

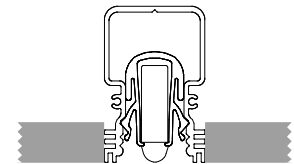

## Recessed Mounting Components & Tools

- Mounting Hardware is included with Plexineon runs in the appropriate quantity, including Extrusion Housing and Plaster Plate. Order extras as desired. Blocking above ceiling built by others.

**75-EXT01-001-00**  
Extrusion Housing (Black)

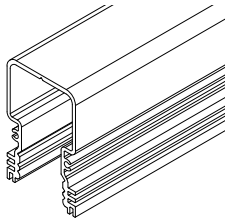

Mount to deck or support backing above ceiling. Ships in 96" sections, field cut to size

**75-CLP32-001-00**  
Recessed Mounting Clip



Placed approximately every 30" as well as 2" from the ends. **Use Glue to adhere with Plexineon fixture.**

**80-MTP01-001-00**  
End Plate

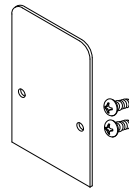

Two per continuous run

**80-PIN03-001-00**  
Alignment Pin

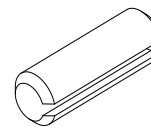

Two for every Extrusion to Extrusion connection.

**80-B5H02-001-00**  
Powerfeed Strain Relief

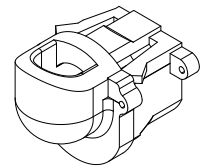

One per driver connection

**35-EXT01-001-00**  
Plaster Plate, Mud-in

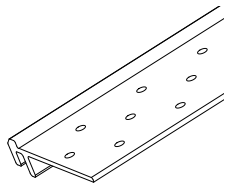

Used for drywall install and mud-in applications

**70-TOL03-001-00**  
Tool

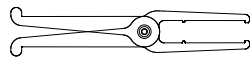

Allows for changing of installation configurations

**35-EXT03-001-00**  
Paint Mask

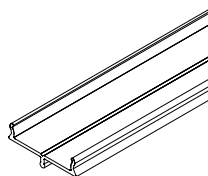

Protects interior of the Extrusion Housing during mud-in and paint

**45-GLU01-001-00**  
Glue



Used to adhere Recessed Mounting Clips to Plexineon fixture

# Plexineon Recessed Mount

RGB, RGBW and RGBW Pixel

## Powerfeed and Connectors

### For use with RGB

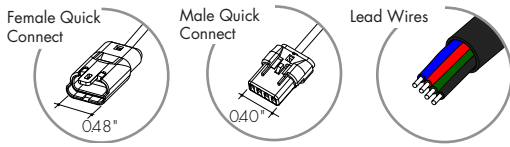

#### 60-SJ-C4-0002-01

Female RGB Quick Connect with 6" flying leads

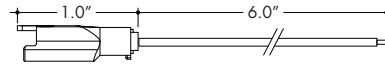

Female Quick Connect with flying leads can be connected to the Power Supply at the start of a run. Can also be used with the Male Quick Connect to make wire jumpers.

Also available with longer Flying Leads

#### 60-SJ-C4-0004-01

Female RGB Quick Connect with 120" flying leads

#### 60-SJ-C4-0001-01

Male RGB Quick Connect with 6" flying leads

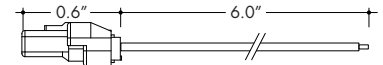

Male Quick Connect with flying leads can be used to make wire jumpers.

Also available with longer Flying Leads

#### 60-SJ-C4-0003-01

Male RGB Quick Connect with 120" flying leads

### For use with RGBW

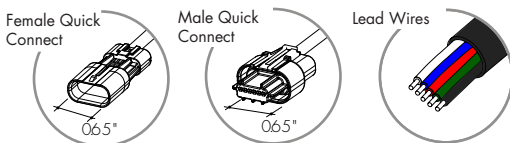

#### 60-SJ-C5-0002-01

Female RGBW Quick Connect with 6" flying leads

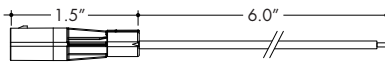

Female Quick Connect with flying leads can be connected to the Power Supply at the start of a run. Can also be used with the Male Quick Connect to make wire jumpers.

Also available with longer Flying Leads

#### 60-SJ-C5-0004-01

Female RGBW Quick Connect with 120" flying leads

#### 60-SJ-C5-0001-01

Male RGBW Quick Connect with 6" flying leads

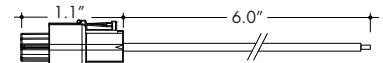

Male Quick Connect with flying leads can be used to make wire jumpers.

Also available with longer Flying Leads

#### 60-SJ-C5-0003-01

Male RGBW Quick Connect with 120" flying leads

### For use with Pixel

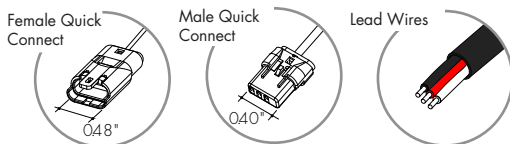

#### 60-SJ-C3-0002-01

Female Pixel Quick Connect with 6" flying leads

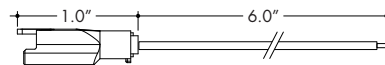

Female Quick Connect with flying leads can be connected to the Power Supply at the start of a run. Can also be used with the Male Quick Connect to make wire jumpers.

Also available with longer Flying Leads

#### 60-SJ-C3-0006-01

Female Pixel Quick Connect with 384" flying leads

#### 60-SJ-C3-0001-01

Male Pixel Quick Connect with 6" flying leads

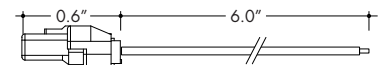

Male Quick Connect with flying leads can be used to make wire jumpers.

Also available with longer Flying Leads

#### 60-SJ-C3-0005-01

Male Pixel Quick Connect with 384" flying leads

#### 60-SJ-C3-0008-01

Female Pixel Quick Connect with 120" flying leads

#### 60-SJ-C3-0007-01

Male Pixel Quick Connect with 120" flying leads

# Plexineon Recessed Mount

RGB, RGBW and RGBW Pixel

## Sample Layout

- Note (Pixel Only): Pixel direction will be shown with a label on the side of the fixture.



### PX-108-SR-RGBW-PXSPI-SO-F-RM-BK-B-4 Plexineon Recessed

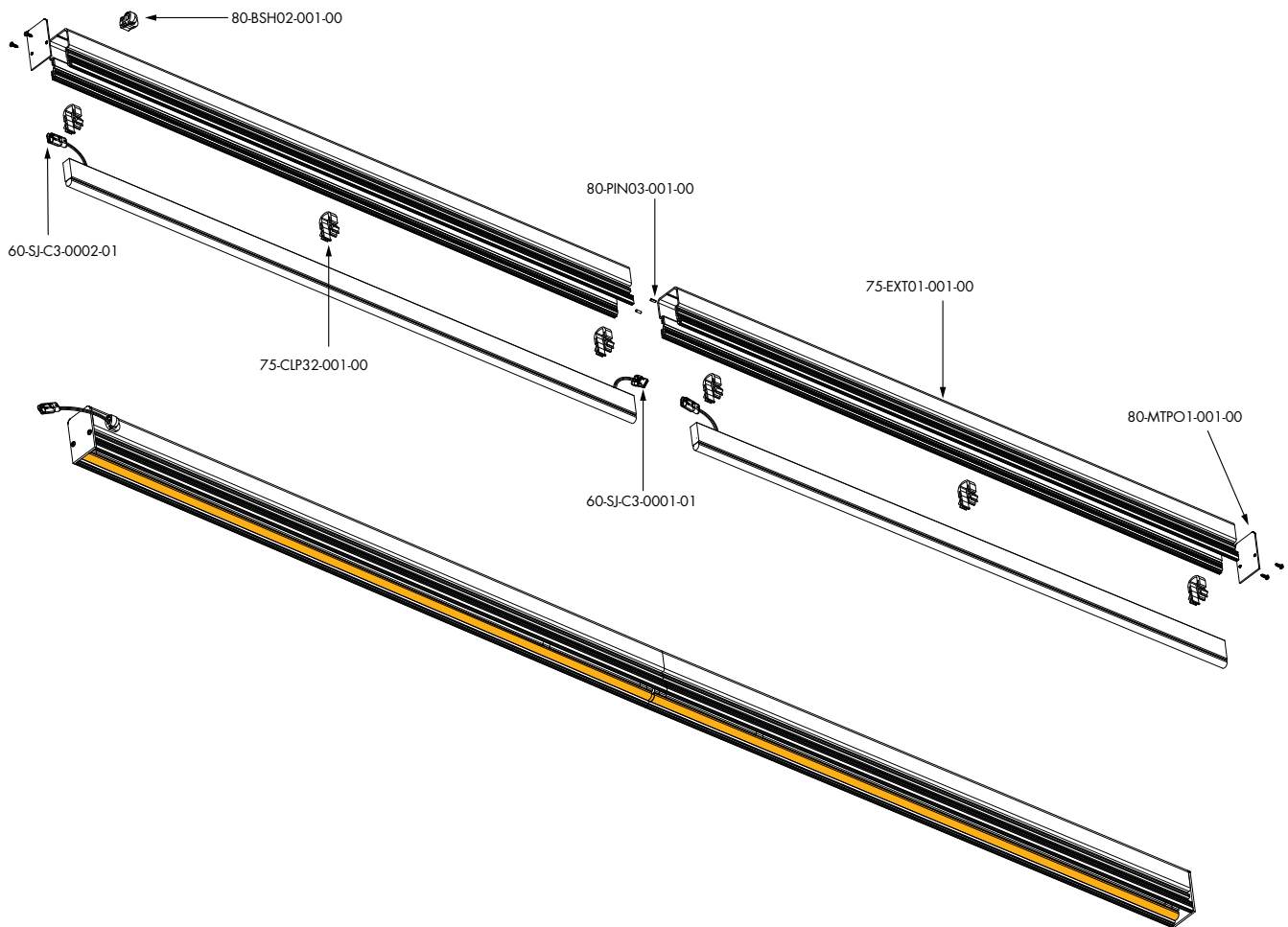

# Plexineon Recessed Mount

RGB, RGBW and RGBW Pixel

## Recessed Mounting Installation

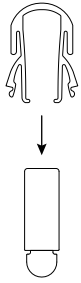

Install Recessed Mounting Clips onto plexineon straight run fixture. **Use glue to fill any gaps between clip and fixture.**

Note: use 1 clip per approximately every 30".

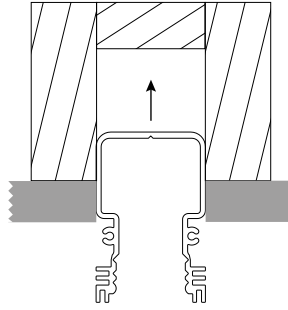

Build blocking above ceiling plane. Screw onto the support blocking or deck.

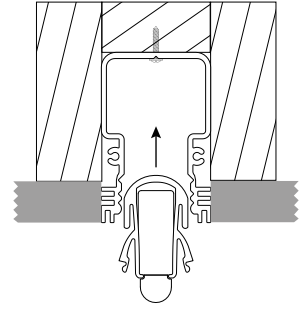

Install Plexineon with Recessed Mounting Clips into Extrusion Housing at desired position.

# Plexineon Recessed Mount

RGB, RGBW and RGBW Pixel



## Power Consumption

Tested at Full Power with PDC Series power supplies.

Standard Nominal Lengths offered provide minimal shadowing. For alternate lengths, please consult Inside Sales with specific request.

### RGB

Nominal Length (in)	Actual Length	Watts	Nominal Length (in)	Actual Length	Watts
7	6 6/16	1.9	54	53 10/16	19
9	8 6/16	2.9	56	55 10/16	19.5
11	10 5/16	3.6	58	57 9/16	20.2
13	12 5/16	4.1	60	59 9/16	21.2
15	14 4/16	4.9	62	61 8/16	21.7
17	16 4/16	5.5	64	63 8/16	22.4
19	18 3/16	6.5	66	65 7/16	23.1
20	20 3/16	7.2	68	67 7/16	23.6
22	22 2/16	7.7	70	69 6/16	24.3
24	24 2/16	8.4	72	71 6/16	25.1
26	26 1/16	9.2	74	73 5/16	25.5
28	28 1/16	10.1	76	75 5/16	26.2
30	30	10.6	78	77 4/16	27
32	32	11.6	80	79 4/16	27.7
34	33 15/16	12.1	82	81 3/16	28.4
36	35 15/16	12.8	83	83 3/16	28.9
38	37 14/16	13.5	85	85 2/16	29.6
40	39 14/16	14.2	87	87 2/16	30.3
42	41 13/16	15.2	89	89 1/16	30.8
44	43 13/16	15.7	91	91 1/16	31.6
46	45 12/16	16.2	93	93	32.2
48	47 12/16	17.1	95	95	32.2
50	49 11/16	17.8			
52	51 11/16	18.3			

### RGBW

Nominal Length (in)	Actual Length	Watts
9	8 6/16	3.8
13	12 5/16	5.5
17	16 4/16	7.7
20	20 3/16	9.4
24	24 2/16	11.5
28	28 1/16	13.5
32	32	15.4
36	35 15/16	17.1
40	39 14/16	18.9
44	43 13/16	20.6
48	47 12/16	22.5
52	51 11/16	24.2
56	55 10/16	25.9
60	59 9/16	27.7
64	63 8/16	29.4
68	67 7/16	31.1
72	71 6/16	32.9
76	75 5/16	34.6
80	79 4/16	35.8
83	83 3/16	37.4
87	87 2/16	38.7
91	91 1/16	40.4
95	95	42.2

### PIXEL

Nominal Length (in)	Actual Length	Watts	Pixel Qty
9	8 6/16	3.6	2
13	12 5/16	5.6	3
17	16 4/16	7.7	4
21	20 3/16	9.6	5
25	24 2/16	11.5	6
29	28 1/16	13.7	7
32	32	15.6	8
36	35 15/16	17.5	9
40	39 14/16	19.1	10
44	43 13/16	21.3	11
48	47 12/16	22.9	12
52	51 11/16	25	13
56	55 10/16	26.9	14
60	59 9/16	28.5	15
64	63 8/16	30.4	16
68	67 7/16	32.3	17
72	71 6/16	34.3	18
76	75 5/16	36.2	19
80	79 4/16	38.1	20
84	83 3/16	40	21
88	87 2/16	41.7	22
92	91 1/16	43.6	23
95	95	45.2	24



### Voltage Drop Calculator

The below chart assumes nominal voltage of 24 Volts and a Voltage Drop Allowance of 3% through the wire

Wattage [W]	Maximum Wire Length From Power Supply to Start of Run [ft]						
	12 AWG	14 AWG	16 AWG	18 AWG	20 AWG	22 AWG	24 AWG
<b>5</b>	1088.2	684.4	430.3	270.6	170.2	107.1	67.3
<b>10</b>	544.1	342.2	215.1	135.3	85.1	53.5	33.7
<b>15</b>	362.7	228.1	143.4	90.2	56.7	35.7	22.4
<b>20</b>	272.0	171.1	107.6	67.7	42.6	26.8	16.8
<b>25</b>	217.6	136.9	86.1	54.1	34.0	21.4	13.5
<b>30</b>	181.4	114.1	71.7	45.1	28.4	17.8	11.2
<b>35</b>	155.5	97.8	61.5	38.7	24.3	15.3	9.6
<b>40</b>	136.0	85.5	53.8	33.8	21.3	13.4	8.4
<b>45</b>	120.9	76.0	47.8	30.1	18.9	11.9	7.5
<b>50</b>	108.8	68.4	43.0	27.1	17.0	10.7	6.7
<b>55</b>	98.9	62.2	39.1	24.6	15.5	9.7	6.1
<b>60</b>	90.7	57.0	35.9	22.6	14.2	8.9	5.6
<b>65</b>	83.7	52.6	33.1	20.8	13.1	8.2	5.2
<b>70</b>	77.7	48.9	30.7	19.3	12.2	7.6	4.8
<b>75</b>	72.5	45.6	28.7	18.0	11.3	7.1	4.5
<b>80</b>	68.0	42.8	26.9	16.9	10.6	6.7	4.2
<b>85</b>	64.0	40.3	25.3	15.9	10.0	6.3	4.0
<b>90</b>	60.5	38.0	23.9	15.0	9.5	5.9	3.7
<b>96</b>	56.7	35.6	22.4	14.1	8.9	5.6	3.5

# Plexineon Recessed Mount

RGB, RGBW and RGBW Pixel



## Power Supplies

See fixture and power supply instructions & spec sheet for wiring information. Dimming possible in select models - view Luminii website for list of compatible dimmers.

### Ordering Code DMX Dimming Power Supplies 0.1% 120VAC - 277VAC Requires Controller

MODEL	INPUT CONTROL	ENVIRONMENT	WATTAGE	OUTPUT
PS-Power Supply, 120-277VAC	DMX-DMX (0.1%)	D-Dry	96-96 Watts 3X96-3X96 Watts	24-24 VDC

MODELS	96W	3X96
Length	14.40"	15.00"
Width	5.20"	6.62"
Depth	2.60"	4.56"

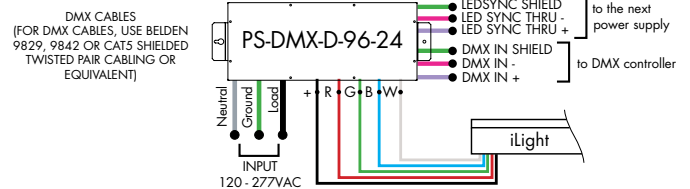
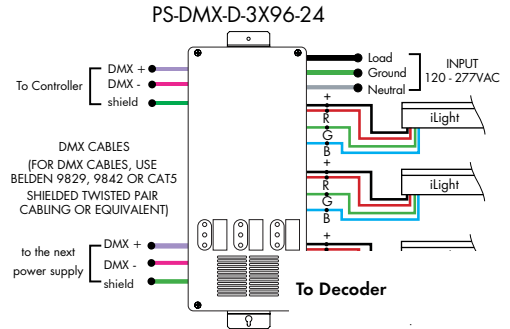

### Ordering Code Non-Dimming Power Supply 120VAC - 277VAC Requires Controller and Decoder

MODEL	INPUT CONTROL	ENVIRONMENT	WATTAGE	OUTPUT
PS-Power Supply, 120-277VAC	ND-Non Dimming	D-Dry	96-96 Watts	24-24 VDC

MODELS	96W
Length	14.40"
Width	5.20"
Depth	2.60"

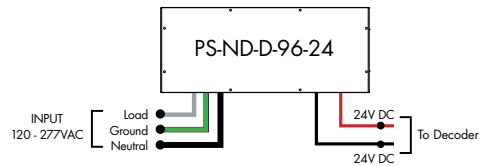

### Ordering Code Universal Dimming Power Supplies 1% 120VAC - 277VAC Requires Controller and Decoder

MODEL	INPUT CONTROL	ENVIRONMENT	WATTAGE	OUTPUT
PS-Power Supply, 120-277VAC	UNI-0-10V Dimming, Phase Dimming	D-Dry W-Wet	30-30 Watts 60-60 Watts 96-96 Watts 3x96-3x96 Watts	24-24 VDC

Compatibility: View a complete list of compatible dimmers on product page [\(Link\)](#)

0-10V - 1% dimming  
MLV/ELV/TRIAC - 1% dimming, consult dimming compatibility chart

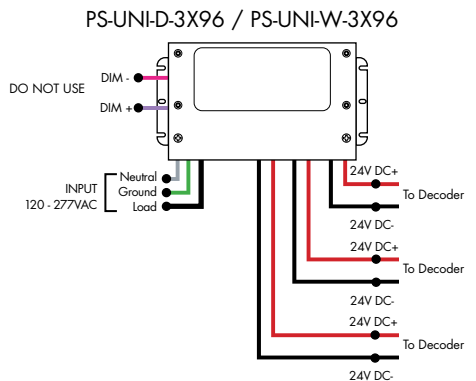
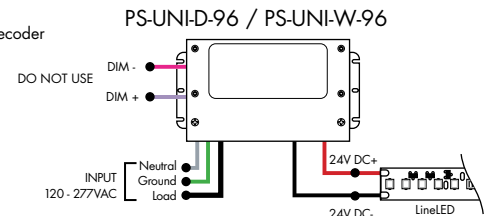

MODELS	PS-UNI-W-30W	PS-UNI-W-60W	PS-UNI-W-96W	PS-UNI-W-3X96W
Length	6.50"	7.40"	8.66"	11.85"
Width	3.73"	3.73"	3.73"	4.32"
Depth	1.61"	1.61"	1.61"	1.81"

MODELS	PS-UNI-D-30W	PS-UNI-D-60W	PS-UNI-D-96W	PS-UNI-D-3X96W
Length	8.77"	8.77"	8.11"	9.94"
Width	4.27"	4.27"	5.60"	7.61"
Depth	1.83"	1.83"	1.83"	2.02"





### Controllers and Decoders



MODEL

**RGBW-RC-R**

RGBW-RC-R - RGBW receiver

The RGBW receiver is easily paired with controller by the click of a button. Receiver can be reset to factory settings at any time.

Each receiver can store one static RGB color, one color sequence, and one brightness setting for the white LED strip. Receivers assigned to the same scene within the same zone will have the same LED static color and color sequence.

**Operating Voltage**  
12-36 VDC

**Power Capacity**  
up to 96W at 24V

**Operating Temperature Range**  
from -4°F to +122°F in case



MODEL

**RGBW-SR**

RGBW-SR - RGBW signal repeater

Extends identical signal when connected in series to an RGBW LED control system. The RGBW signal repeater works with Luminii RGB and RGBW controllers, receivers, and decoders.

RGBW signal can be extended indefinitely when adequate power supply (not included) is connected to the system.

**Operating Voltage**  
12-36 VDC

**Power Capacity**  
up to 96W at 24V

**Operating Temperature Range**  
from -4°F to +122°F in case



MODEL

**DDMX-RGBW**

DDMX-RGBW - DMX decoder

Translates controller DMX512 programs for RGB and white LED strips.

Unique DMX address for the decoder can be set easily and displayed by the numeric display on the case. Changing and resetting the DMX address requires manual input.

Use power repeater to expand output.

**Operating Voltage**  
12-36 VDC

**Power Capacity**  
up to 96W at 24V

**Operating Temperature Range**  
from -4°F to +122°F in case

# Plexineon Recessed Mount

RGB, RGBW and RGBW Pixel



## Controllers and Decoders



MODEL

**RGBW-MC3**

RGBW-MC3-4-zone RGBW controller

Easy to operate wireless interface suitable for static or color changing scenes. Control 4 different color zones separately or at the same time. RGBW receiver (RGBW-RC-R) required for operation. Assign multiple receivers per zone to cover a large area.

Color wheel enables highly stable and sensitive color control functionality. Create your own color changing sequences with ease and flexibility.

### Power

qty 3 AAA batteries

### Scenes

up to 4 unique zones

### Signal

Wireless (RF)

### Energy Saving

Deactivates after 10 seconds of inactivity

### Color Parameters

- Brightness
- Saturation
- Primary colors
- Speed of color changing sequence
- Fading

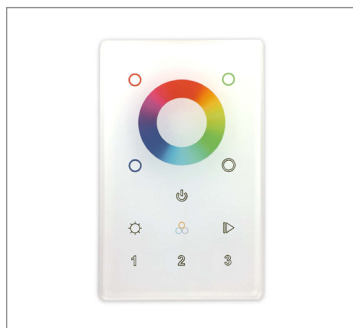

MODEL

ZONES

COLOR

DMX - DMX  
Controller

3Z - Three Zone  
1Z - One Zone

RGBW - Red,  
Green,  
Blue, &  
White

DMX /Wireless RGB-W wall-mount controller controls DMX lighting fixtures, wireless control of RGB-W lighting fixture or use both simultaneously. Fits in any standard US switch box. Includes all the outputs in the back of the controller.

Control brightness levels with a single touch, personalize and memorize 3 different scenes, and even create 3 variations of white.

### Features

- 2 in 1 in-Wall Controller: DMX Control or Wireless RGB-W
- 65,000 Color Options, Dimming and Speed Control
- Memory Function
- 50 Foot Wireless Range
- Easily Fits Standard US Switch Boxes
- Touch Sensitive Glass Surface
- Includes 10 Built in Programs, or Create and Play Your Own

### Operating Voltage

12 - 24V DC

### Color Parameters

- Brightness
- Saturation
- Primary colors
- Fading
- Color changing speed

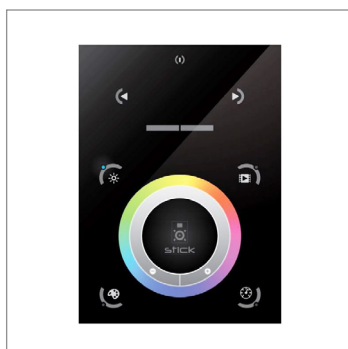

MODEL

**TSDMX-E**

TSDMX-E - Touchscreen DMX controller

Programmable advanced DMX512 lighting controller featuring a touch-screen interface. Operates as stand alone controller or integrated with most architectural lighting control systems. Can controller endless DMX512 enabled devices.

Mounts to standard single or dual gang wall box with the included power supply inside the junction box. Terminal block design for power and data connections.

### Features

- Sleek glass design which sits 0.43" from the wall
- Graphical color display to show selected environment
- Color/dimmer/speed palette
- Color temperature mixing
- Touch sensitive buttons. No mechanical parts
- Touch sensitive wheel allows for accurate color selection
- Multi-zone microSD memory
- Multi-room control with 500 scenes, 10 zones
- 1024 DMX channels. Control 340 RGB fixtures
- USB & Ethernet connectivity for programming and control

### Power Supply

7 VDC (included)

### Programmability

PC, Mac, Tablet, Smartphone

### Output Signal

DMX512 (1024 channels)

### Color Parameters

- Brightness
- Saturation
- Speed of color changing sequence
- Fading / dimming / brightness



### Controllers and Decoders



MODEL

**SR-DMX-SPI**

SR-DMX-SPI - Smart Pixel Decoder

The SR-DMX-SPI is a smart LED pixel decoder that controls RGB/RGBW pixel LED strips with SPI signal. Designed with an OLED backlit panel, the pixel controller allows for easy configuration of most settings. Four push buttons are available for control of the LED functions.  
\*For pixel only.

#### Features

- 2 in 1 in-Wall Controller: DMX Control or Wireless RGB-W
- SPI signal output for RGB/RGBW pixel light control
- DMX512 controllable and RF/WIFI remote controllable
- Capable of addressing up to 1020 RGB pixels & 765 RGBW pixels
- OLED panel allows for easy configuration

#### Operating Voltage

12 - 36V DC

#### Power capacity

up to 96W at 24V

#### Operating temperature range

from -4°F to +122°F in case



MODEL

**DDMX-5CH-RDM-PRO**

DDMX-5CH-RDM-PRO-DMX512 Decoder

DMX512 decoder with RDM functionality features 5 PWM output channels with common anode. High PWM output frequency range allows the product to be used in HD video conferencing spaces. All DMX products to be installed per DMX512 Standard.

#### Power

96 Watt

#### Inputs

RJ45, XLR-5Pin, Terminal Block

#### DMX Channels

1 to 5 settable

#### PWM Output Resolution Ratio

8 or 16 bit

#### PWM Output Frequency

500Hz - 30KHz

#### Output Dimming Curve Gamma Value

0.1 ~ 9.9



MODEL

**RGBW-WI-R**

RGBW-WI-R - WIFI generator

RGBW-WI-R creates a local network that enables any electronic device (phone, tablet, etc.) to control the RGB/W strip connected to a RGBW-RC-R receiver.

The control functions are achieved through a free application download for Android and iOS devices called REALCOLOR.

#### Operating Voltage

12-36 VDC

#### Power Supply

PI-130-24 (included)

#### Operating Temperature Range

from -4°F to +122°F in case