

Features

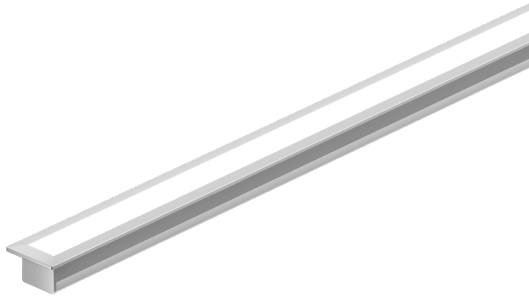

- 24VDC Class 2 fixtures made to order up to 144". Fixtures can be linked up to 37' depending on output
- Suitable for millwork, recessed, architectural reveals, and accent lighting applications
- Proprietary strong bond solder method handles up to 50 lbs of pull force on wire leads and connectors
- Dot free even illumination with frosted lens and high color outputs
- Class 2 listed for damp locations
- Warm Dim follows the incandescent dimming curve and is compatible with MLV, ELV, and Incandescent dimmers.
- Tunable White allows individual control of CCT and output, can be paired with Vintage Dim power supply for warm dim effect
- Average Life (L70): 50,000hrs
- 5 year warranty

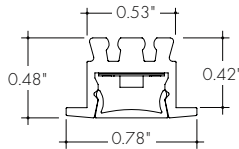

Finish Options (see page 3 for additional information)

Base	<input type="checkbox"/> Silver Anodized
Powder Coat	<input type="checkbox"/> Black <input type="checkbox"/> Bronze <input type="checkbox"/> White
Premium	<input type="checkbox"/> Matte Black <input type="checkbox"/> Warm Nickel <input type="checkbox"/> Aged Brass <input type="checkbox"/> Polished Gold <input type="checkbox"/> Chrome



Technical Information

TYPE	Warm Dim			Tunable White		
	WD51 (22K-38K)			TW51 (22K-40K)		
OUTPUT OPTIONS	SO	HO	VHO	SO	HO	VHO
Lumens Output (3000K) <small>(All On w/ Clear Lens)</small>	111 lm/ft	234 lm/ft	332 lm/ft	191 lm/ft	234 lm/ft	322 lm/ft
Average Power Consumption <small>(for a 4' section)</small>	2.3 W/ ft	4.7 W/ ft	6.9 W/ ft	4.4 W/ ft	5.4 W/ ft	7.6 W/ ft
Efficacy	48 lm/W	50 lm/W	48 lm/W	43 lm/W	43 lm/W	42 lm/W
Max Run Length <small>(in series)</small>	37 ft	22 ft	15 ft	27.9 ft	22 ft	15 ft
Ambient Operating Temperature Range*	-13°F - 113°F <small>(-25°C - 45°C)</small>	-13°F - 95°F <small>(-25°C - 35°C)</small>	-13°F - 77°F <small>(-25°C - 25°C)</small>	-13°F - 95°F <small>(-25°C - 35°C)</small>		-13°F - 77°F <small>(-25°C - 25°C)</small>
Control/Dimming Protocol	0-10V, DALI, DALI2, MLV (Triac), ELV, Incandescent			0-10V, DMX, DALI-DT8		

*Ambient Operating Temperature Range to maintain L70 of 50k+ hours in normal mounting conditions for the fixture. Exceeding Ambient Operating Temperature Range may result in decreased life/output. Consult Technical Support for specific inquiries.

Warm Dim Wet (WD51)

CCT	Multiplier <small>(ref. - 18K30K)</small>	TM-30			
		CRI	R _f	R _g	R ₉
22K30K	0.95	96	81	87	94
		98	96	100	96
22K35K	1.00	96	81	87	94
		98	96	101	99
22K38K	1.00	96	81	87	94
		98	96	102	93

Tunable White Wet (TW51)

CCT		TM-30			
		CRI	R _f	R _g	R ₉
22K40K	2200K	96	81	87	94
	3000K	98	96	102	97
	4000K	95	93	100	86

Ordering Code

MODEL	LENGTH ¹	OUTPUT ²	CCT	LENS	MOUNTING	FINISH ³	FEED POSITION LEFT ⁵	FEED POSITION RIGHT ⁵
MKRW - Myka Recessed Trimmed Wet	12"-144" 2" increments	WD51SO - Standard WD51HO - High WD51VHO - Very High	22K30K 2200K- 3000K 22K35K - 2200K- 3500K 22K38K 2200K- 3800K	C - Clear F - Frosted	HS - Hard Surface Mounting Bracket GS - Gypsum Surface Mounting Bracket NB - No Bracket	BASE SA - Silver Anodized POWDER COAT BK - Black BZ - Bronze WH - White PREMIUM MBK - Matte Black WVN - Warm Nickel AB - Aged Brass PG - Polished Gold ⁴ CH - Chrome ⁴	WIRE LEADS (72") LWE - Wire End Feed LWB - Wire Back Feed LNPF - No Power Feed	WIRE LEADS (72") RWE - Wire End Feed RWB - Wire Back Feed RNPF - No Power Feed
	12"-144" 2" increments	TW51SO - Standard TW51HO - High TW51VHO - Very High	22K40K - 2200K- 4000K				QUICK CONNECTS (6") LFE - Female Q/C, End Feed LFB - Female Q/C, Back Feed LNPF - No Power Feed	QUICK CONNECTS (6") RFE - Female Q/C, End Feed RFB - Female Q/C, Back Feed RNPF - No Power Feed

1 - Custom lengths and increments are available, please consult Inside Sales with specific request.
2 - Warm Dim and Tunable White options can be used to comply with Title 24 JAB at max brightness depending on lens selection, see multiplier charts to calculate specific efficacy.

3 - Non Base finishes may have extended lead times and price adders. Custom RALs are available, contact Inside Sales with specific request.
4 - Polished Gold, and Chrome finishes have a maximum fixture length of 96".
5 - LNPF - RNPF is not a valid configuration option

Powerfeeds and Connectors

Power Feed Position Options and Orientation

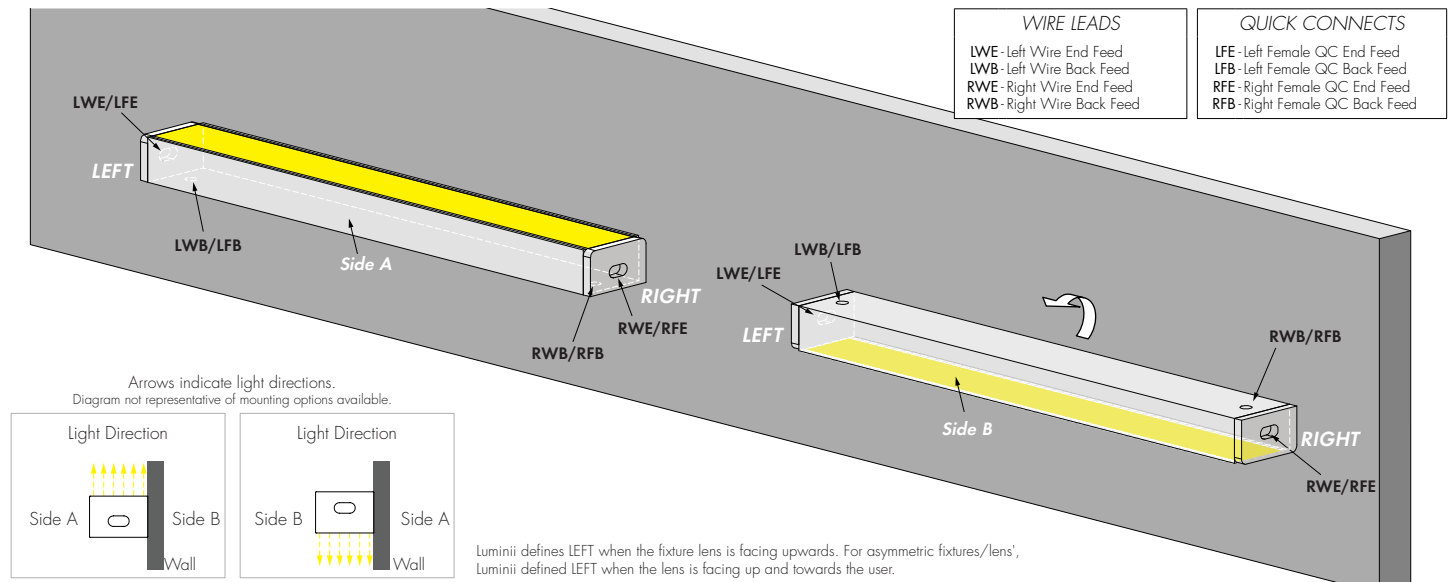

Linking and Extension Cable Options

For use with Warm Dim (WD51):

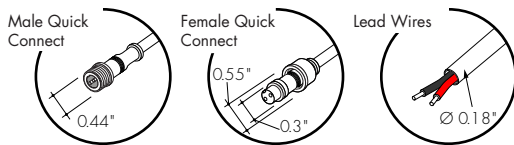

WET-FMA-2-2
 Female to Male Adapter, 2 pin

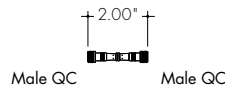

WET-CON-LEAD-M-2-48
 Male Wet Connector Cable, 2 pin, 48"

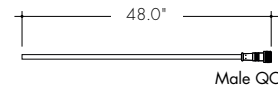

WET-CON-JC-F-M-2-48
 Female/Male Wet Jumper Cable, 2 pin, 48"

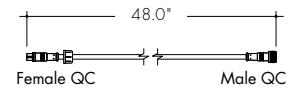

For use with Tunable White (TW51):

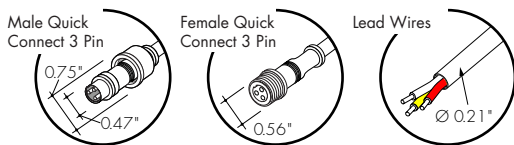

WET-MFA-3-2
 Male to Female Adapter, 3 pin

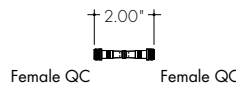

WET-CON-LEAD-F-3-48
 Female Wet Connector Cable, 3 pin, 48"

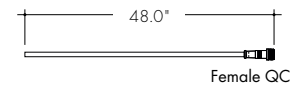

WET-CON-JC-M-F-3-48
 Male/Female Wet Jumper Cable, 3 pin, 48"

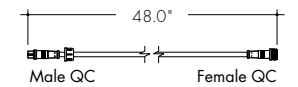

Sample Layout

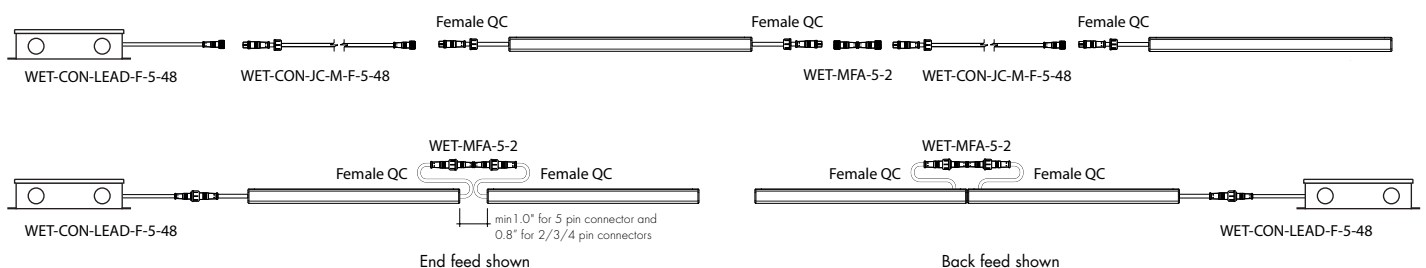

Product Dimensions

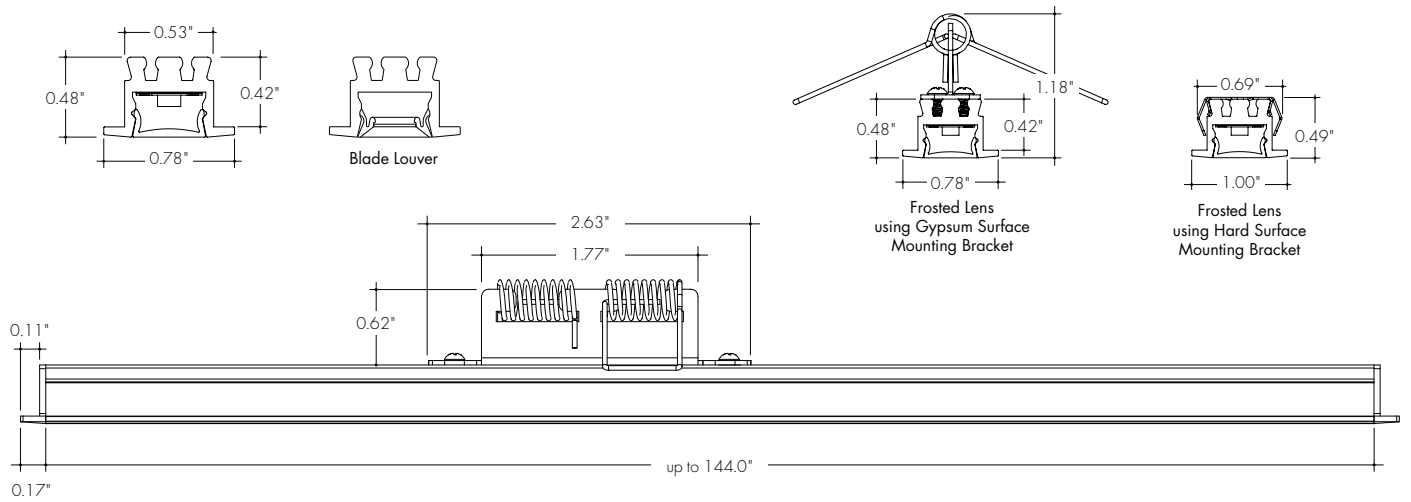

Finish Options

- Finish options are available in a wide variety, allowing for complete customization of style and aesthetic.
- Non Base finishes may have extended lead times and price adder.
- Polished Gold and Chrome finishes have a maximum fixture length of 96".
- Custom RALs are available, please consult Inside Sales with specific request.

Silver Anodized Base

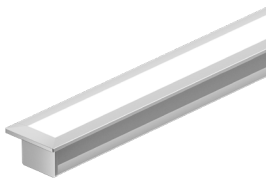

Silver Anodized is a soft silver with a clear finish.

Black Powder Coat



Black is a true deep black with a glossy finish.

Bronze Powder Coat

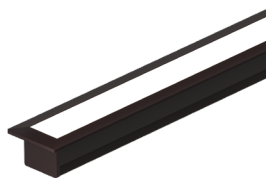

Bronze is a rich, dark brown with a satin finish.

White Powder Coat



White is a polar bright white and field paintable.

Matte Black Premium

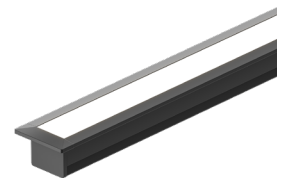

Matte Black is a dark, pitch-black with a soft flat finish.

Warm Nickel Premium



Warm Nickel is a soft, silvery smoke with warm tones and a satin finish.

Aged Brass Premium

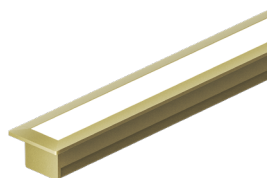

Aged Brass is a deep brown shade with slightly golden undertones.

Polished Gold Premium

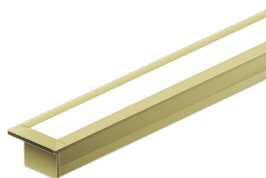

Polished Gold is bright and radiant for a brilliant finish.

Chrome Premium

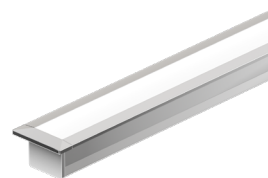

Chrome is a highly reflective silver polish.

Light Transmission and Dotting

Output Options	Lens/Accessory							
	Clear Lens				Frosted Lens			
Dimming Level	100%	50%	10%	1%	100%	50%	10%	1%
WD51SO	CD	CD	CD	CD	ND	SD	SD	SD
WD51HO	CD	CD	CD	CD	ND	SD	SD	SD
WD51VHO	CD	CD	CD	CD	ND	SD	SD	SD
TW51SO (All On)	CD	CD	CD	CD	ND	SD	SD	CD
TW51HO (All On)	CD	CD	CD	CD	ND	SD	SD	CD
TW51VHO (All On)	CD	CD	CD	CD	ND	SD	SD	CD
TW51SO (1 CH)	CD	CD	CD	CD	ND	SD	SD	CD
TW51HO (1 CH)	CD	CD	CD	CD	ND	SD	SD	CD
TW51VHO (1 CH)	CD	CD	CD	CD	ND	SD	SD	CD
Transmission Percentage	100%				54%			

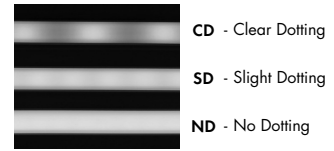

Use complete Dotting Chart Tool online for more dotting information

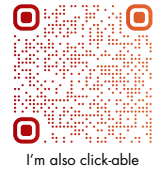

Accessory Options

LVSP-WET

Splice box: wet rated, low voltage, gray, IP66

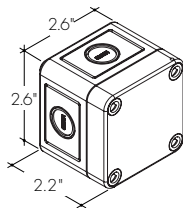

LVSP-WET-CM

Connector for splice box, low voltage for cable management, gray.

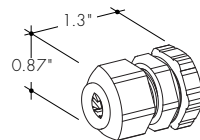

Power Consumption

Please visit the link/QR code below to access the Luminii Power Consumption Chart tool on our website.

There you will be able to select your fixture, output, and desired power feed to get a full power consumption table.



I'm also click-able

Desired Nominal Length: _____

Desired Output: _____

Desired CCT: _____

Voltage Drop Calculator

The below chart assumes nominal voltage of 24 Volts and a Voltage Drop Allowance of 3% through the wire

Wattage [W]	Maximum Wire Length From Power Supply to Start of Run [ft]						
	12 AWG	14 AWG	16 AWG	18 AWG	20 AWG	22 AWG	24 AWG
5	1088.2	684.4	430.3	270.6	170.2	107.1	67.3
10	544.1	342.2	215.1	135.3	85.1	53.5	33.7
15	362.7	228.1	143.4	90.2	56.7	35.7	22.4
20	272.0	171.1	107.6	67.7	42.6	26.8	16.8
25	217.6	136.9	86.1	54.1	34.0	21.4	13.5
30	181.4	114.1	71.7	45.1	28.4	17.8	11.2
35	155.5	97.8	61.5	38.7	24.3	15.3	9.6
40	136.0	85.5	53.8	33.8	21.3	13.4	8.4
45	120.9	76.0	47.8	30.1	18.9	11.9	7.5
50	108.8	68.4	43.0	27.1	17.0	10.7	6.7
55	98.9	62.2	39.1	24.6	15.5	9.7	6.1
60	90.7	57.0	35.9	22.6	14.2	8.9	5.6
65	83.7	52.6	33.1	20.8	13.1	8.2	5.2
70	77.7	48.9	30.7	19.3	12.2	7.6	4.8
75	72.5	45.6	28.7	18.0	11.3	7.1	4.5
80	68.0	42.8	26.9	16.9	10.6	6.7	4.2
85	64.0	40.3	25.3	15.9	10.0	6.3	4.0
90	60.5	38.0	23.9	15.0	9.5	5.9	3.7
96	56.7	35.6	22.4	14.1	8.9	5.6	3.5

Power Supplies

See fixture and power supply instructions & spec sheet for wiring information. Dimming possible in select models - view Luminii website for list of compatible dimmers.

For use with Warm Dim

Ordering Code - Universal Dimming Power Supplies 0.1% 120VAC - 277VAC

MODEL	INPUT CONTROL	WATTAGE	OUTPUT
PS-Power Supply, 120-277VAC	UNI - 0-10V Dimming (0.1%), Phase Dimming (0.1%)	30 - 30 Watts 60 - 60 Watts 96 - 96 Watts 3x96 - 3x96 Watts	24 - 24 VDC

Compatibility: View a complete list of compatible dimmers on the PS-UNI product page.

0-10V - 0.1% dimming
MLV/ELV/TRIAC - 0.1% dimming, consult dimming compatibility chart

MODELS	PS-UNI-30W	PS-UNI-60W	PS-UNI-96W	PS-UNI-3X96W
Length	6.50"	7.40"	8.66"	11.85"
Width	3.73"	3.73"	3.73"	4.32"
Depth	1.61"	1.61"	1.61"	1.81"

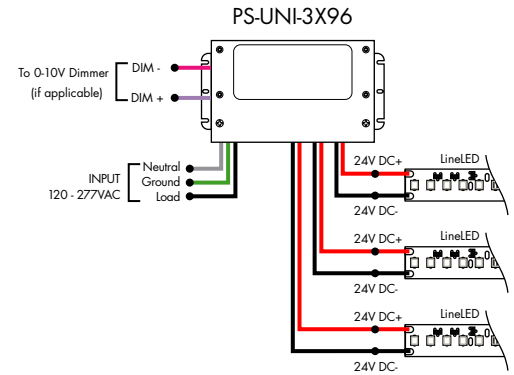
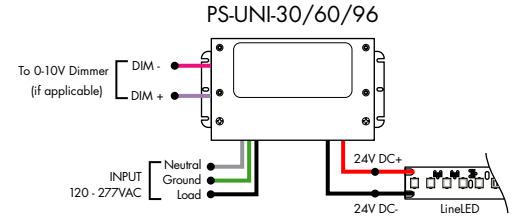

Ordering Code - DALI 2 Dimming Power Supplies 0.1% 120VAC - 277VAC

MODEL	INPUT CONTROL	ENVIRONMENT	WATTAGE	OUTPUT
PS-Power Supply, 120-277VAC	DALI2-DT6 - DALI2 DT6 (0.1%)	D - Dry	96 - 96 Watts	24 - 24 VDC

Model	96W
Length	14.40"
Width	5.20"
Depth	2.60"

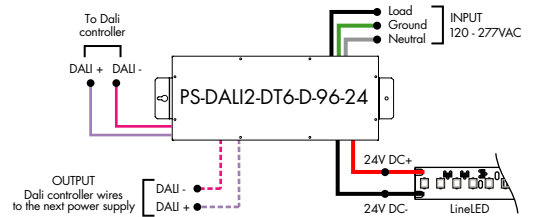

Power Supplies

See fixture and power supply instructions & spec sheet for wiring information. Dimming possible in select models - view Luminii website for list of compatible dimmers.

For use with Warm Dim

Ordering Code - 0-10V Dimming Power Supplies 0.1% 120VAC - 277VAC

MODEL	INPUT CONTROL	ENVIRONMENT	WATTAGE	OUTPUT
PS - Power Supply, 120-277VAC	010V-LIN - 0-10V Dimming (0.1%), Linear 010V-LOG - 0-10V Dimming (0.1%), Logarithmic	D - Dry	96-96 Watts 3x96-3x96 Watts	24 - 24 VDC

MODELS	96W	3X96
Length	14.40"	15.00"
Width	5.20"	6.62"
Depth	2.60"	4.45"

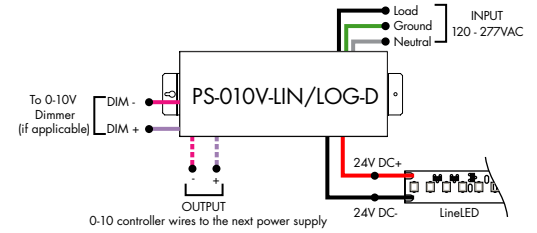

PS-010V-LIN/LOG-D-3X96

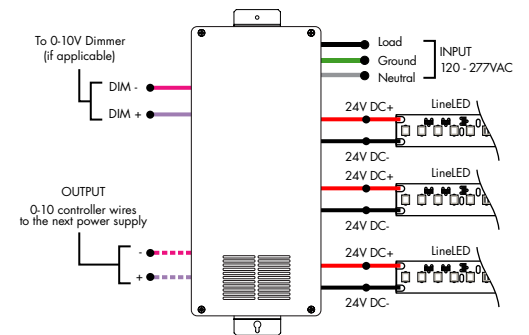

Ordering Code - Athena 0-10V LED Driver

MODEL	INPUT CONTROL	ENVIRONMENT	WATTAGE	OUTPUT	FEATURE
PS - Power Supply, 120-277VAC	010V-LIN - 0-10V Dimming (0.1%), Linear 010V-LOG - 0-10V Dimming (0.1%), Logarithmic	D - Dry	96-96 Watts	24 - 24 VDC	AWNDR - Athena

MODELS	96W
Length	14.40"
Width	5.20"
Depth	2.60"

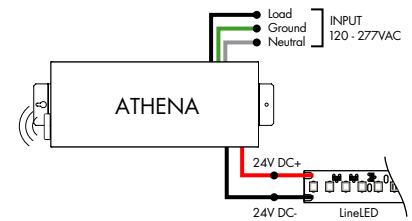

Power Supplies

See fixture and power supply instructions & spec sheet for wiring information. Dimming possible in select models - view Luminii website for list of compatible dimmers.

For use with Tunable White

Ordering Code - DALI2 Dimming Power Supplies 0.1% 120VAC - 277VAC

MODEL	INPUT CONTROL	ENVIRONMENT	WATTAGE	OUTPUT
PS - Power Supply, 120-277VAC	DALI2-DT8 - DALI DT8 Tunable White (0.1%)	D - Dry	96 - 96 Watts	24 - 24 VDC

MODELS	96W
Length	14.40"
Width	5.20"
Depth	2.60"

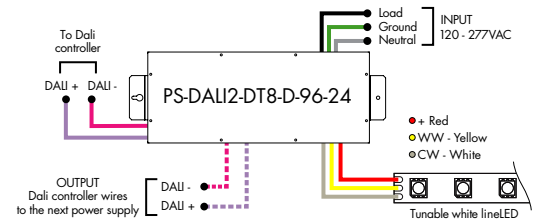

Ordering Code - Athena DALI2 Dimming Power Supplies 0.1% 120VAC - 277VAC

MODEL	INPUT CONTROL	ENVIRONMENT	WATTAGE	OUTPUT	FEATURE
PS - Power Supply, 120-277VAC	DALI2-DT8 - DALI DT8 Tunable White (0.1%)	D - Dry	96 - 96 Watts	24 - 24 VDC	AWN - Athena

MODELS	96W
Length	14.40"
Width	5.20"
Depth	2.60"

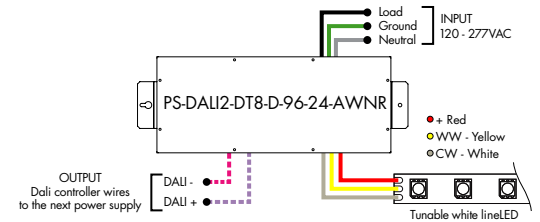

Ordering Code - DALI2 Dimming Power Supplies 0.1% 120VAC - 277VAC - for Dim-to-Warm functionality with Tunable White Output

MODEL	INPUT CONTROL	ENVIRONMENT	WATTAGE	OUTPUT
PS - Power Supply, 120-277VAC	DALI2-WD - DALI2 DT6 Warm Dim (0.1%)	D - Dry	96 - 96 Watts	24 - 24 VDC

MODELS	96W
Length	14.40"
Width	5.20"
Depth	2.60"

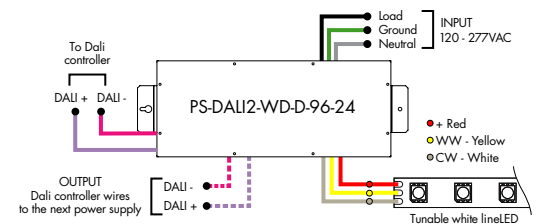

Ordering Code - DMX Dimming Power Supplies 0.1% 120VAC - 277VAC

MODEL	INPUT CONTROL	ENVIRONMENT	WATTAGE	OUTPUT
PS - Power Supply, 120-277VAC	DMX - DMX (0.1%)	D - Dry	96 - 96 Watts 3X96 - 3X96 Watts	24 - 24 VDC

MODELS	96W	3X96
Length	14.40"	15.00"
Width	5.20"	6.62"
Depth	2.60"	4.56"

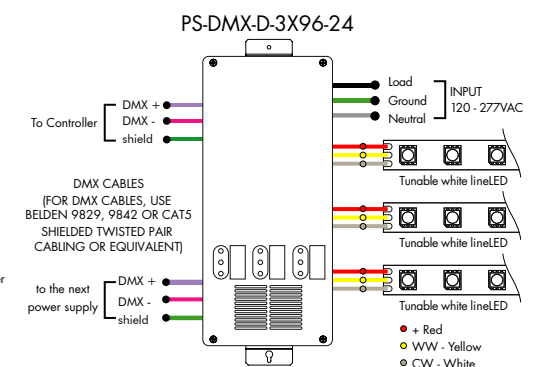
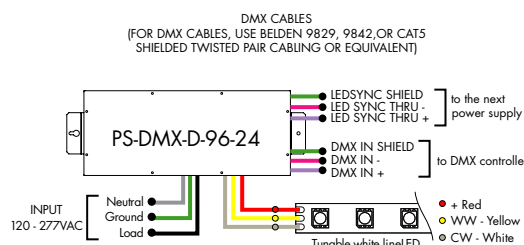

Power Supplies

See fixture and power supply instructions & spec sheet for wiring information. Dimming possible in select models - view Luminii website for list of compatible dimmers.

For use with Tunable White

Ordering Code - VintageDim® 0-10V Dimming Power Supplies 0.1% 120VAC - 277VAC

MODEL	INPUT CONTROL	ENVIRONMENT	WATTAGE	OUTPUT
PS - Power Supply, 120-277VAC	010V-WD - 0-10V Dimming (0.1%), Standard Warm Dim Curve (with Tunable White LED) 010V-TW - 0-10V Dimming (0.1%), Two Channel Control, Brightness and CCT1-CCT2 Ratio 010V-2CH - 0-10V Dimming (0.1%), Two Channel Control, LED1 Brightness and LED2 Brightness 010V-WDX - 0-10V Dimming (0.1%), Customizable Warm Dim Curve (with Tunable White LED) 010V-2CHX - 0-10V Dimming (0.1%), Two Channel Control, Customizable Brightness and CCT1-CCT2 Ratio	D-Dry	96-96 Watts 3X96-3x96 Watts ¹	24-24 VDC

1 - 3x96 is only available with input control options 010V-WD and 010V-TW

MODELS	96W	3X96
Length	14.40"	15.00"
Width	5.20"	6.62"
Depth	2.60"	4.56"

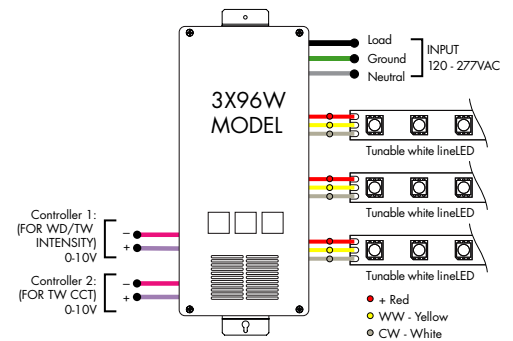
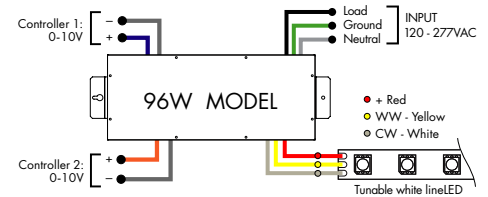

Ordering Code - Athena VintageDim® 0-10V Power Supply 0.1% 120VAC - 277VAC - for Dim-to-Warm functionality with Tunable White Output

MODEL	INPUT CONTROL	ENVIRONMENT	WATTAGE	OUTPUT	FEATURE
PS - Power Supply, 120-277VAC	010V-WD - 0-10V Dimming, Standard Warm Dim Curve (with Tunable White LED)	D-Dry	96-96 W	24-24 VDC	AWNDR - Athena

MODELS	96W
Length	14.40"
Width	5.20"
Depth	2.60"

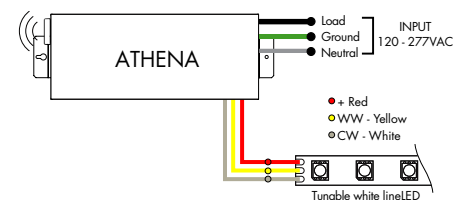

Ordering Code - Athena VintageDim® 0-10V Two Channel LED Driver, 0.1% 120VAC - 277VAC

MODEL	INPUT CONTROL	ENVIRONMENT	WATTAGE	OUTPUT	FEATURE
PS - Power Supply, 120-277VAC	010V-2CH - 0-10V Dimming Two Channel Control, LED1 Brightness and LED2 Brightness	D-Dry	96-96 W	24-24 VDC	AWNDR - Athena

MODELS	96W
Length	14.40"
Width	5.20"
Depth	2.60"

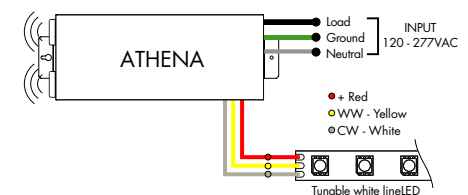

Controllers and Decoders

For use with Tunable White Power Supplies



ORDERING CODE

MODEL

DTW-MC

DTW-MC - Tunable White controller

Tunable White wall-mount controller controls lighting fixtures, wireless control of TW lighting fixture. Fits in any standard US switch box. Includes all the outputs in the back of the controller.

Features

- Switch & dimming control function, control range > 20M.
- Smooth transition between light levels.
- Separately operate dimming and color temperature functions.
- Able to control 1 zone with endless receivers. Each receiver can maximally be controlled by 8 remotes.
- Power, temperature color and dimming functions operated by push button after receivers are connected.

Operating Voltage

3V DC battery

Color Parameters

- Brightness
- Saturation
- Fading



ORDERING CODE

MODEL

TW-DMX

TW-DMX - DMX controller

Tunable White DMX wall-mount controller is a fully touch sensitive controller designed in accordance with standard dimming protocol DMX512. Offers fast and accurate color temperature adjustment and brightness dimming of natural white, warm white and cold white. Designed with a touch color wheel, the DMX512 controller can adjust color temperature and brightness for all white LEDs smoothly and accurately. The DMX controller can control 1 zone with endless decoders.

Features

- 1 zone
- 6 color scenes
- DMX Control
- Touch Sensitive Glass Surface
- Dimming and Speed Control
- Memory Function
- Easily Fits Standard US Switch Boxes

Operating Voltage

12 - 24V DC

Color Parameters

- Brightness
- Saturation
- Primary colors
- Fading
- Color changing speed



ORDERING CODE

MODEL

SLD-DIMTW

SLD-DIMTW - Tunable white LED dimming module

The SLD DimTW is a constant voltage warm dimming LED dimming module. The unique dimming module accepts 0-10V control and mimics a smooth, incandescent dimming curve.

Features

- Flicker free 0-100% dimming
- High efficiency up to 97%
- High precision dimming ratio:>1:1000
- Fully isolated plastic housing
- Comply with EN55015 and FCC part 15 without additional input filter and capacitors
- compact size, high reliability
- 3 years warranty

Operating Voltage

8-48 VDC

Controllers and Decoders

For use with Tunable White, RGB/RGBW Power Supplies



Translates controller DMX512 programs for RGB and white LED strips.
 Unique DMX address for the decoder can be set easily and displayed by the numeric display on the case. Changing and resetting the DMX address requires manual input.
 Use power repeater to expand output.

Operating Voltage

12-36 VDC

Power Capacity

up to 96W at 24V

Operating Temperature Range

from -4°F to +122°F in case

ORDERING CODE

MODEL

DDMX-RGBW

DDMX-RGBW - DMX decoder



The RGBW receiver is easily paired with controller by the click of a button. Receiver can be reset to factory settings at any time.

Each receiver can store one static RGB color, one color sequence, and one brightness setting for the white LED strip. Receivers assigned to the same scene within the same zone will have the same LED static color and color sequence.

Operating Voltage

12-36 VDC

Power Capacity

up to 96W at 24V

Operating Temperature Range

from -4°F to +122°F in case

ORDERING CODE

MODEL

RGBW-RC-R

RGBW-RC-R - RGBW receiver



Extends identical signal when connected in series to an RGBW LED control system. The RGBW signal repeater works with Luminii RGB and RGBW controllers, receivers, and decoders.

RGBW signal can be extended indefinitely when adequate power supply (not included) is connected to the system.

Operating Voltage

12-36 VDC

Power Capacity

up to 96W at 24V

Operating Temperature Range

from -4°F to +122°F in case

ORDERING CODE

MODEL

RGBW-SR

RGBW-SR - RGBW signal repeater

Controllers and Decoders

For use with Tunable White, RGB/RGBW Power Supplies

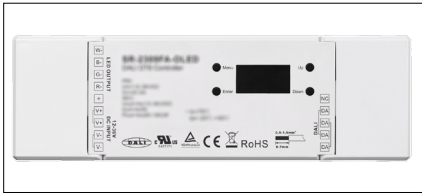

A 4-channel DALI2 DT8 decoder designed to control RGB, RGBW, and TW LED fixtures, featuring adjustable color temperature and customizable lumen output.

Voltage/Frequency
12-36VDC

Ambient Operating Temperature Range
-20 to 50 °C

Max Output Power
4 output channels, 60-180W each

Environment
Dry (IP20)

Max Output Current
4 output channels, max of 5A each

ORDERING CODE

MODEL

DALI2-DT8-RGBW

DALI2-DT8-RGBW - DALI-2 RGBW Decoder



DMX512 decoder with RDM functionality features 5 PWM output channels with common anode. High PWM output frequency range allows the product to be used in HD video conferencing spaces. All DMX products to be installed per DMX512 Standard.

Power

96 Watt

PWM Output Resolution Ratio

8 or 16 bit

Inputs

RJ45, XLR-5Pin, Terminal Block

PWM Output Frequency

500Hz - 30KHz

DMX Channels

1 to 5 settable

Output Dimming Curve Gamma Value

0.1 ~ 9.9

ORDERING CODE

MODEL

DDMX-5CH-RDM-PRO

DDMX-5CH-RDM-PRO - DMX512 Decoder



RGBW-WI-R creates a local network that enables any electronic device (phone, tablet, etc.) to control the RGB/W strip connected to a RGBW-RC-R receiver.

The control functions are achieved through a free application download for Android and iOS devices called REALCOLOR.

Operating Voltage

12-36 VDC

Operating Temperature Range

from -4°F to +122°F in case

Power Supply

PI-130-24 (included)

ORDERING CODE

MODEL

RGBW-WI-R

RGBW-WI-R - WIFI generator

For use with Tunable White, RGB/RGBW, Pixel Power Supplies

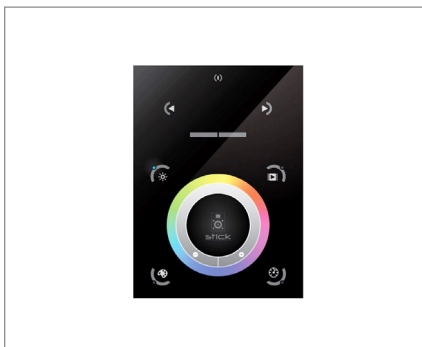

Programmable advanced DMX512 lighting controller featuring a touch-screen interface. Operates as stand alone controller or integrated with most architectural lighting control systems. Can controller endless DMX512 enabled devices.

Mounts to standard single or dual gang wall box with the included power supply inside the junction box. Terminal block design for power and data connections.

Features

- Sleek glass design which sits 0.43" from the wall
- Graphical color display to show selected environment
- Color/dimmer/speed palette
- Color temperature mixing
- Touch sensitive buttons. No mechanical parts
- Touch sensitive wheel allows for accurate color selection
- Multi-zone microSD memory
- Multi-room control with 500 scenes, 10 zones
- 1024 DMX channels. Control 340 RGB fixtures
- USB & Ethernet connectivity for programming and control

Power Supply

7 VDC (included)

Programmability

PC, Mac, Tablet, Smartphone

Output Signal

DMX512 (1024 channels)

Color Parameters

- Brightness
- Saturation
- Speed of color changing sequence
- Fading / dimming / brightness

ORDERING CODE

MODEL

TSDMX-E

TSDMX-E - Touchscreen DMX controller