

Features

- 24VDC Class 2 fixtures made to order up to 144". Fixtures can be linked up to 48' depending on output
- Available with plenum rated wire leads or with integral junction box for splice connection
- Class 2 listed for damp locations
- Dot free even illumination
- Proprietary strong bond solder method handles up to 50 lbs of pull force on wire leads and connectors
- Approved for closet/storage space installation per NEC 410.16(A) (3) and 410.16(C)(5) on outputs 5.7W/ft or less
- High Color Quality options offer premium quality and vibrant colors with R9 values up to 97
- High Efficacy options offer best in class output and efficacy with over 625 lm/ft and up to 79 lm/W
- Average Life (L70): 50,000hrs
- 7 year warranty

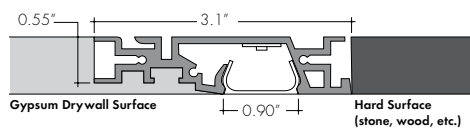
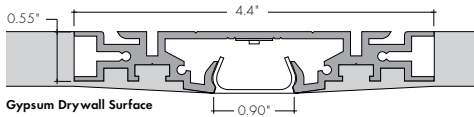

Technical Information

MODEL	High Color Quality			High Efficacy				High Efficacy	
	72SO	72HO	72VHO	HE48LO	HE48SO	HE48MO	HE48HO	HE64VHO	HE64XHO
OUTPUT OPTIONS									
Lumens Output (3000K) <small>(with a Frosted Lens)</small>	153 lm/ft	248 lm/ft	302 lm/ft	149 lm/ft	206 lm/ft	275 lm/ft	441 lm/ft	559 lm/ft	628 lm/ft
Average Power Consumption <small>(for a 4' section)</small>	2.8 W/ft	4.8 W/ft	6 W/ft	1.9 W/ft	2.8 W/ft	3.5 W/ft	6.5 W/ft	7.5 W/ft	9.6 W/ft
Efficacy	55 lm/W	52 lm/W	50 lm/W	78 lm/W	74 lm/W	79 lm/W	68 lm/W	75 lm/W	65 lm/W
Max Run Length <small>(in series)</small>	40 ft	31 ft	22 ft	48 ft	42 ft	33 ft	21 ft	15 ft	13 ft
* Ambient Operating Temperature Range	-5°F - 125°F <small>(-20°C - 50°C)</small>			-5°F - 125°F <small>(-20°C - 50°C)</small>				-5°F - 125°F <small>(-20°C - 50°C)</small>	

* Ambient Operating Temperature Range to maintain L70 of 50k+ hours in normal mounting conditions for the fixture. Exceeding Max Ambient Temperature may result in decreased life/output. Consult Technical Support for specific inquiries.

High Color Quality (72)

CCT	Multiplier <small>(reference - 3000K)</small>	TM-30			
		CRI	R _f	R _g	R ₉
1900K	0.55	96	94	97	90
2200K	0.70	96	95	101	89
2400K	0.72	98	97	101	91
2700K	0.74	97	96	101	91
3000K	1.00	97	95	104	97
3500K	1.02	97	94	105	97
4100K	1.07	97	90	99	97

High Efficacy (HE48/HE64)

CCT	Multiplier <small>(reference - 3000K)</small>	TM-30			
		CRI	R _f	R _g	R ₉
2200K	0.73	92	91	97	42
2500K	0.81	93	96	96	62
2700K	0.94	92	90	99	58
3000K	1.00	92	89	99	57
3500K	1.02	92	89	99	60
4000K	1.02	92	86	94	71

Ordering Code

MODEL	LENGTH ¹	OUTPUT ²	CCT	LENS	MOUNTING	LEFT END CAP ³	RIGHT END CAP ³	POWER SUPPLY TYPE
LN - Linii	12"-144" 1" increments	72SO - Standard 72HO - High 72VHO - Very High	19K - 1900K 22K - 2200K 24K - 2400K 27K - 2700K 30K - 3000K 35K - 3500K 41K - 4100K	F - Frosted FS - Frosted Silicone L - Lens N - No Lens	GDS - Gypsum Drywall Surface DHS - Drywall to Hard Surface	LE - Endcap Left End LN - No Endcap Left End	RE - Endcap Right End RN - No Endcap Right End	CPB - Center Power Feed, Plenum rated 72" wires CJB - Center Power Feed, Junction Box
	12"-144" 2" increments	HE48LO - Low HE48SO - Standard HE48MO - Medium HE48HO - High HE64VHO - Very High HE64XHO - Max	22K - 2200K 25K - 2500K 27K - 2700K 30K - 3000K 35K - 3500K 40K - 4000K			LE - Endcap Left End LN - No Endcap Left End LNJ - No Endcap Left End, with jumper	RNJ - No Endcap Right End, with jumper	CPB - Center Power Feed, Plenum rated 72" wires CJB - Center Power Feed, Junction Box CNPF - No Power Feed
						LNJ - No Endcap Left End, with jumper	RE - Endcap Right End RN - No Endcap Right End RNJ - No Endcap Right End, with jumper	CPB - Center Power Feed, Plenum rated 72" wires CJB - Center Power Feed, Junction Box CNPF - No Power Feed

1 - Custom lengths and increments are available, please consult Inside Sales with specific request.
 2 - All High Efficacy options can be used to comply with Title 24 JAB. High Color Quality options can be used to comply with Title 24 JAB depending on Output, CCT, and Lens selections. See multiplier charts to calculate specific efficacies.
 3 - Fixtures with a jumper can either give or receive power from an adjacent fixture. Adjacent fixtures with their own individual power feed should NOT also be electrically joined together with jumpers

Linii GDS Corner Options

LIN-IC
Inner Corner

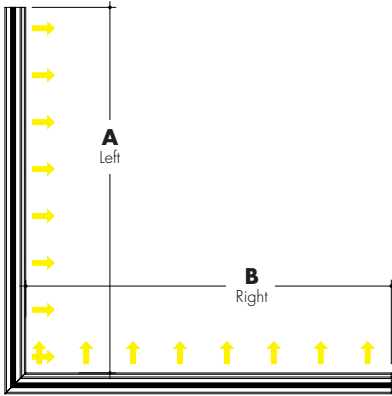
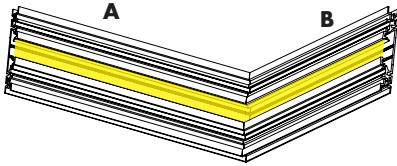

LIN-FC
Flat Corner

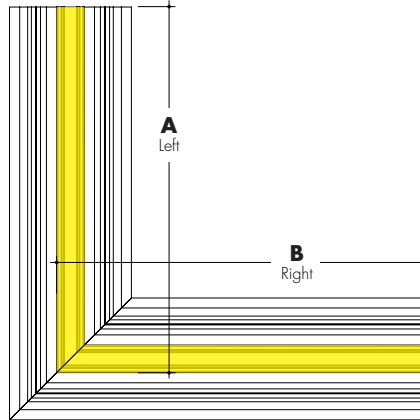
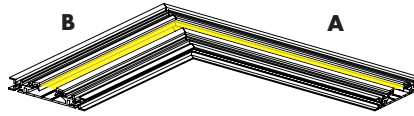

LIN-OC
Outside Corner

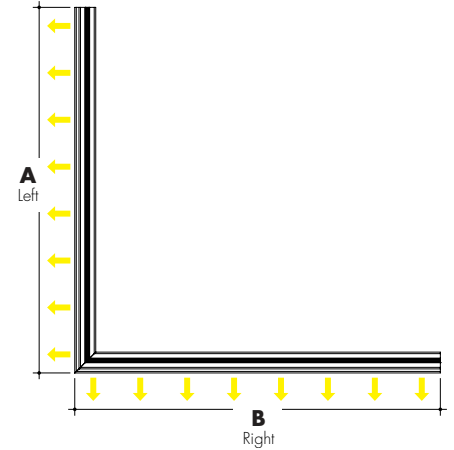
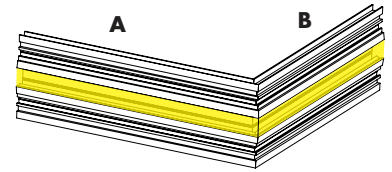

High Color Quality	Actual Length		Total Wattage		
	A	B	72SO	72HO	72VHO
Corner Type					
Flat (LIN-FC)	11 11/16	12 5/16	5.3	9.0	12.1
Outer (LIN-OC)	12 5/16	12 5/16	5.3	9.0	12.1
Inner (LIN-IC)	11 2/16	11 2/16	5.3	9.0	12.1

High Efficacy	Actual Length		Total Wattage				Actual Length		Total Wattage	
	A	B	HE48LO	HE48SO	HE48MO	HE48HO	A	B	HE64SO	HE64HO
Corner Type										
Flat (LIN-FC)	12	12 11/16	3.4	4.9	6.4	13.2	12 5/16	13	14.5	18.3
Outer (LIN-OC)	12 9/16	12 9/16	3.4	4.9	6.4	13.2	12 14/16	12 14/16	14.5	18.3
Inner (LIN-IC)	11 6/16	11 6/16	3.4	4.9	6.4	13.2	11 11/16	11 11/16	14.5	18.3

Ordering Code

MODEL	CORNER TYPE	ANGLE ¹	OUTPUT ²	CCT	LENS	MOUNTING	LEFT END CAP ³	RIGHT END CAP ³	POWER SUPPLY TYPE
LIN-Linii	IC - Inner Corner OC - Outer Corner FC - Flat Corner	90 - 90° Corner C Custom Angle Corner ¹	72SO - Standard 72HO - High 72VHO - Very High	19K - 1900K 22K - 2200K 24K - 2400K 27K - 2700K 30K - 3000K 35K - 3500K 41K - 4100K	F - Frosted Lens FS - Frosted Silicone Lens N - No Lens	GDS - Gypsum Drywall Surface	LE - Endcap Left End LN - No Endcap Left End	RE - Endcap Right End RN - No Endcap Right End	CPB - Center Power Feed, Plenum rated 72" wires CJB - Center Power Feed, Junction Box
			HE48LO - Low HE48SO - Standard HE48MO - Medium HE48HO - High HE64VHO - Very High HE64XHO - Max	22K - 2200K 25K - 2500K 27K - 2700K 30K - 3000K 35K - 3500K 40K - 4000K			LE - Endcap Left End LN - No Endcap Left End LNJ - No Endcap Left End, with jumper	RNJ - No Endcap Right End, with jumper	CPB - Center Power Feed, Plenum rated 72" wires CJB - Center Power Feed, Junction Box CNPF - No Power Feed
							LNJ - No Endcap Left End, with jumper	RE - Endcap Right End RN - No Endcap Right End RNJ - No Endcap Right End, with jumper	CPB - Center Power Feed, Plenum rated 72" wires CJB - Center Power Feed, Junction Box CNPF - No Power Feed

1 - Custom Angle Corners are available, please consult Inside Sales with specific request.

2 - All High Efficacy options can be used to comply with Title 24 JAB. High Color Quality options can be used to comply with Title 24 JAB depending on Output, CCT, and lens selections. See multiplier charts to calculate specific efficacies.

3 - Cant be paired with LE - RE option

Linii DHS Corner Options

LIN-FC1

Flat Corner (Option 1)

LIN-FC2

Flat Corner (Option 2)

LIN-IC

Inner Corner

LIN-OC

Outside Corner

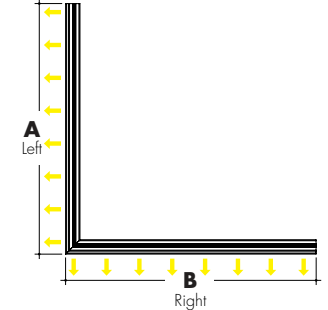
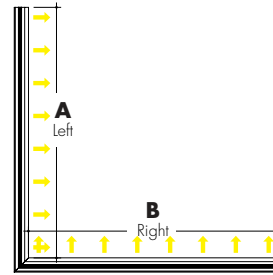
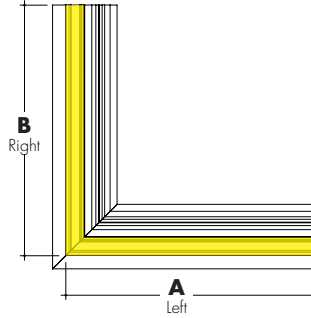
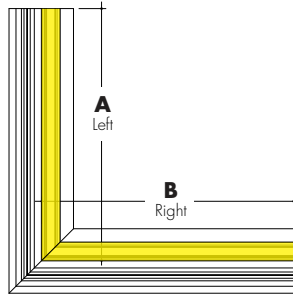
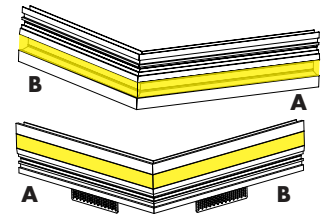
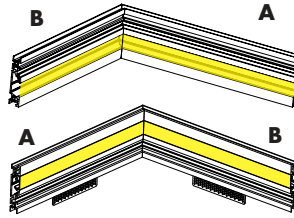
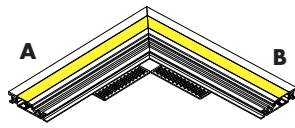
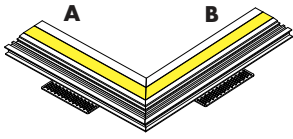

Corner Type	Actual Length		Total Wattage		
	A	B	72SO	72HO	72VHO
Flat Option 1 (LIN-FC1)	11 11/16	12 5/16	5.3	9.0	12.1
Flat Option 2 (LIN-FC2)	11 11/16	12 5/16	5.3	9.0	12.1
Outer (LIN-OC)	12 5/16	12 5/16	5.3	9.0	12.1
Inner (LIN-IC)	11 2/16	11 2/16	5.3	9.0	12.1

Corner Type	Actual Length		Total Wattage				Actual Length		Total Wattage	
	A	B	HE48LO	HE48SO	HE48MO	HE48HO	A	B	HE64SO	HE64HO
Flat Option 1 (LIN-FC1)	12	12 11/16	3.4	4.9	6.4	13.2	12 5/16	13	14.5	18.3
Flat Option 2 (LIN-FC2)	12	12 11/16	3.4	4.9	6.4	13.2	12 5/16	13	14.5	18.3
Outer (LIN-OC)	12 9/16	12 9/16	3.4	4.9	6.4	13.2	12 14/16	12 14/16	14.5	18.3
Inner (LIN-IC)	11 6/16	11 6/16	3.4	4.9	6.4	13.2	11 11/16	11 11/16	14.5	18.3

Ordering Code

MODEL	CORNER TYPE	ANGLE ¹	OUTPUT ²	CCT	LENS	MOUNTING	LEFT END CAP ³	RIGHT END CAP ³	POWER SUPPLY TYPE
LIN-Linii	IC - Inner Corner OC - Outer Corner FC1 - Flat Corner (option 1) FC2 - Flat Corner (option 2)	90 - 90° Corner C Custom Angle Corner	72SO - Standard 72HO - High 72VHO - Very High	19K - 1900K 22K - 2200K 24K - 2400K 27K - 2700K 30K - 3000K 35K - 3500K 41K - 4100K	F - Frosted Lens FS - Frosted Silicone Lens N - No Lens	DHS - Drywall to Hard Surface	LE - Endcap Left End LN - No Endcap Left End	RE - Endcap Right End RN - No Endcap Right End	CPB - Center Power Feed, Plenum rated 72" wires CJB - Center Power Feed, Junction Box
			HE48LO - low HE48SO - Standard HE48MO - Medium HE48HO - High HE64VHO - Very High HE64XHO - Max	22K - 2200K 25K - 2500K 27K - 2700K 30K - 3000K 35K - 3500K 40K - 4000K			LE - Endcap Left End LN - No Endcap Left End LNJ - No Endcap Left End, with jumper	RNJ - No Endcap Right End, with jumper	CPB - Center Power Feed, Plenum rated 72" wires CJB - Center Power Feed, Junction Box CNPF - No Power Feed
							LNJ - No Endcap Left End, with jumper	RE - Endcap Right End RN - No Endcap Right End RNJ - No Endcap Right End, with jumper	CPB - Center Power Feed, Plenum rated 72" wires CJB - Center Power Feed, Junction Box CNPF - No Power Feed

1 Custom Angle Corners are available, please consult Inside Sales with specific request.
2 - All High Efficacy options can be used to comply with Title 24 JAB. High Color Quality options can be used to comply with Title 24 JAB depending on Output, CCT, and lens selections. See multiplier charts to calculate specific efficacies.

3 - Cant be paired with LE - RE option

Powerfeed options for Straight Fixtures

LIN-LE-RE-CPB

Wire leads, plenum rated CL3R cable on Straight Fixture

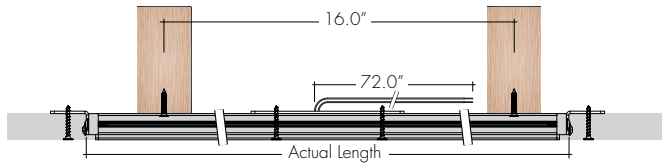

LIN-LE-RE-CJB

One integrated junction box centered on Straight fixture

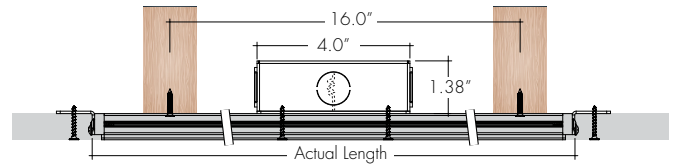

LIN-LE-RNJ-CNPF

No Power Feed, fixture is receiving power from adjacent fixture with jumper

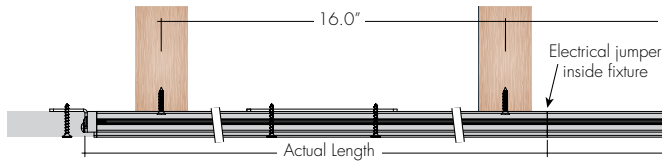

Powerfeed options for Corner Fixtures

LIN-FC-90-XX-DHS-CPB

Wire Leads centered on segment B of corner

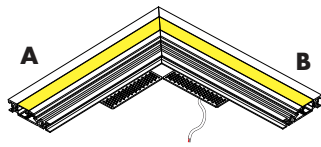

LIN-IC-90-XX-DHS-CPB

Wire Leads centered on segment B of corner

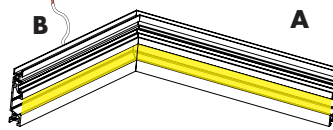

LIN-OC-90-XX-DHS-CPB

Wire Leads centered on segment B of corner

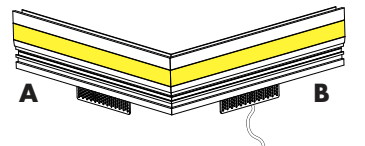
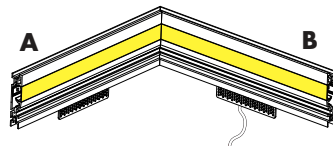
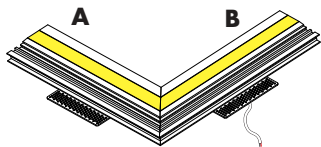
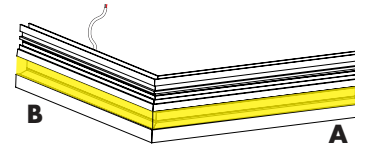

LIN-FC-90-XX-GDS-CPB

Wire Leads centered on segment B of corner

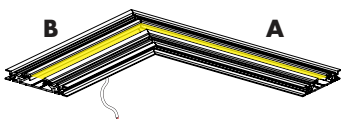

LIN-IC-90-XX-GDS-CPB

Wire Leads centered on segment B of corner

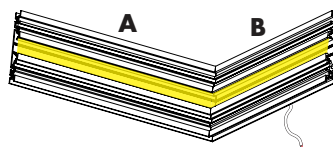

LIN-OC-90-XX-GDS-CPB

Wire Leads centered on segment B of corner

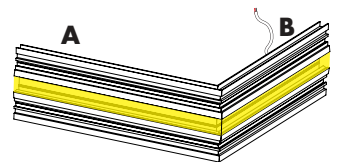

Note: Plenum wire leads are shown, but the same standard also applied to the junction box which is also centered on segment B of the corner fixture.

Product Dimensions

Linii GDS - Gypsum Drywall Surface

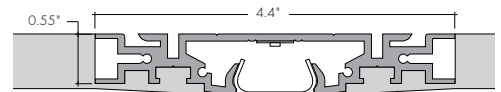
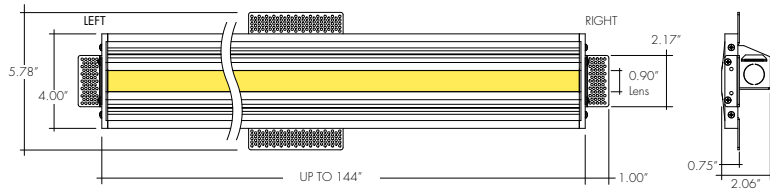

Linii DHS - Gypsum Drywall Surface to Hard Surface

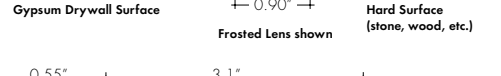
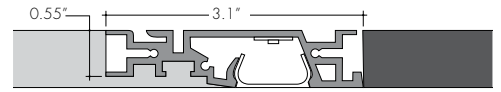
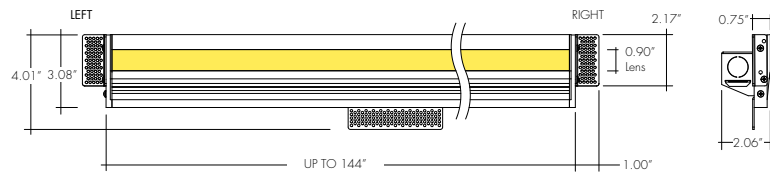

Accessory Options

Continuous Lens (Field Cuttable)

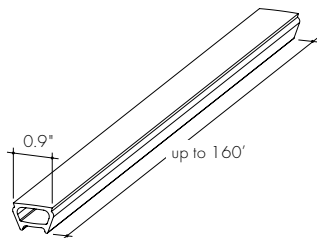

LINC-FS - Linii Channel Continuous Frosted Silicone Lens **XX** - Order in 10' increments up to 160'

Note: Order the continuous (field cuttable) lens up to 160'. Recommended to avoid seams between multiple fixtures joining together.

LVSP-4T-BK

Low Voltage, 4 Terminal Splice Box, Black

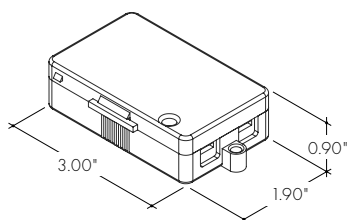

Sample Layout of Power Feed

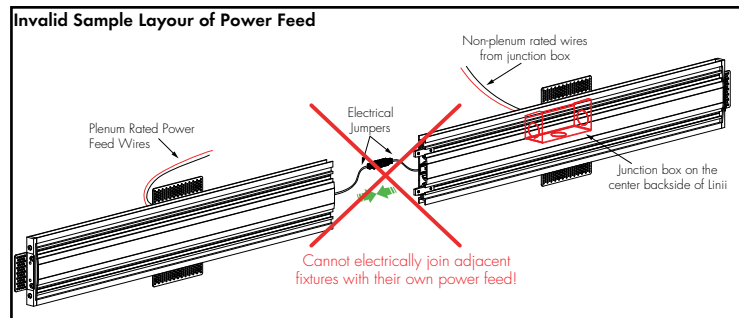
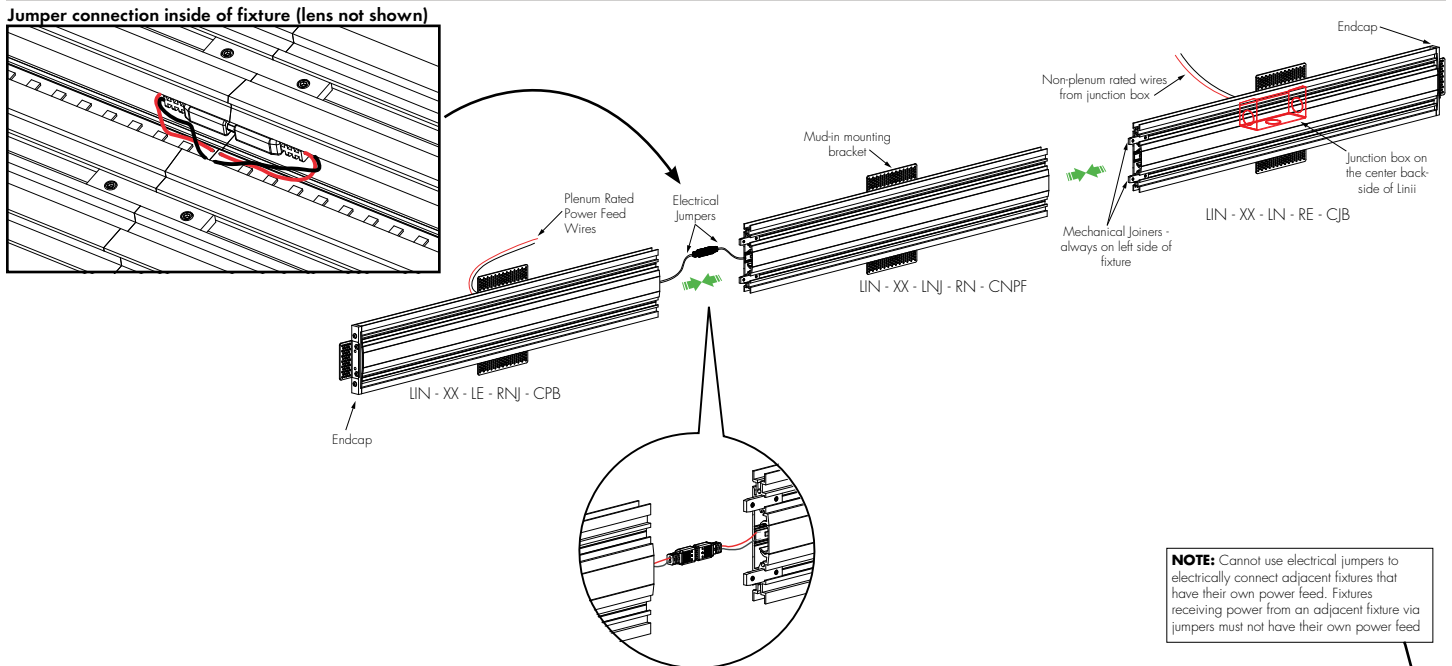

Powerfeeds and Connectors

Linking and Extension Cable Options

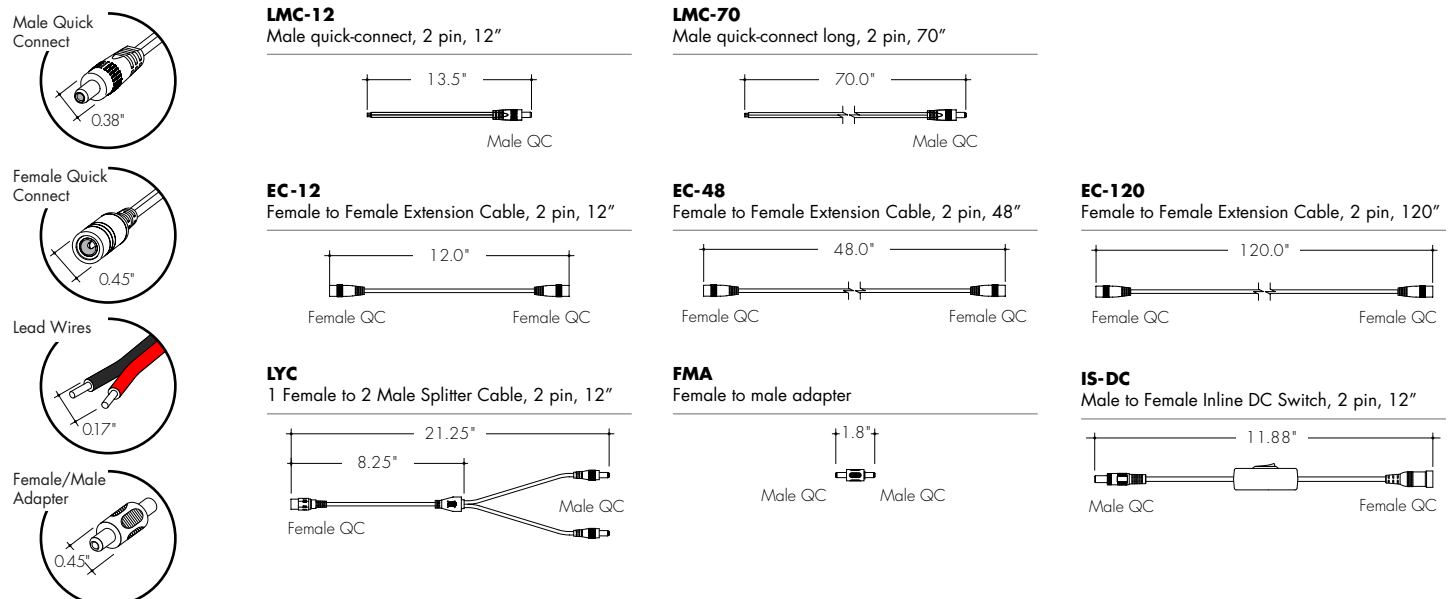

Layout Example

Corner types and straight runs are ordered individually

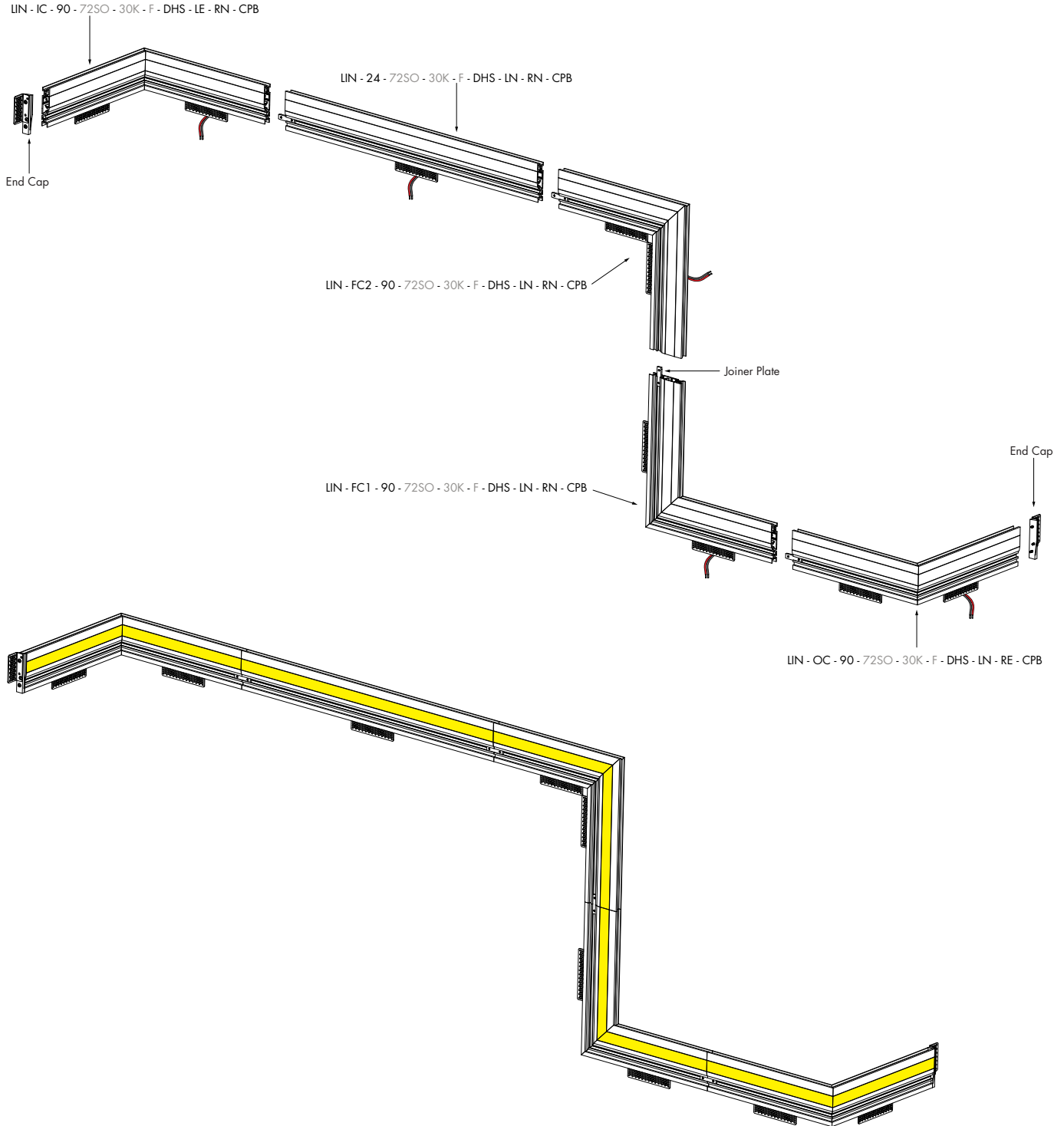

Light Transmission and Dotting

Output Type	Lens/Accessory							
	Frosted				Frosted Silicone			
Dimming Level	100%	50%	10%	1%	100%	50%	10%	1%
72SO	ND	ND	ND	ND	ND	ND	ND	ND
72HO	ND	ND	ND	ND	ND	ND	ND	ND
72VHO	ND	ND	ND	ND	ND	ND	ND	ND
HE48LO	ND	ND	ND	ND	ND	ND	ND	ND
HE48SO	ND	ND	ND	ND	ND	ND	ND	ND
HE48MO	ND	ND	ND	ND	ND	ND	ND	ND
HE48HO	ND	ND	ND	ND	ND	ND	ND	ND
HE64VHO	ND	ND	ND	ND	ND	ND	ND	ND
HE64XHO	ND	ND	ND	ND	ND	ND	ND	ND
Transmission Percentage	100%				107%			

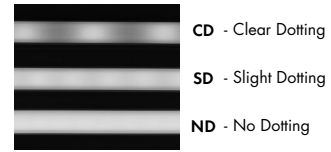

Photometry

LIN-48-30K-72VHO-F

Linii, 4ft, 3000K, VHO, Frosted Lens

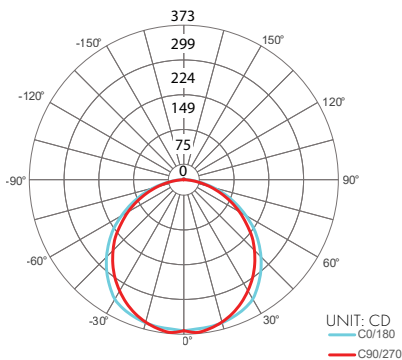

Zonal Lumen Summary 3000K

Zone	Lumen	% Fixture
0-30	295	26.1%
0-40	487	43.2%
0-60	873	77.4%
0-90	1117	99.0%
0-180	1128	100.0%



LIN-48-30K-LL72VHO-FS

Linii, 4ft, 3000K, VHO, Frosted Silicon Lens

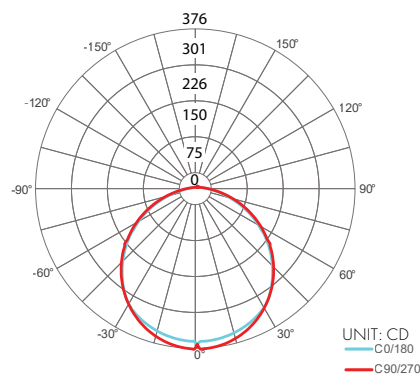

Zonal Lumen Summary 3000K

Zone	Lumen	% Fixture
0-30	320	26.5%
0-40	528	43.7%
0-60	939	77.8%
0-90	1192	98.8%
0-180	1207	100.0%



Power Consumption

Tested at Full Power with PS-UNI Series power supplies.

Standard Nominal Lengths offered provide minimal shadowing. For alternate lengths, please consult Inside Sales with specific request.

High Color Quality (72)

Nominal Length (in)	Actual Length	Watts			Nominal Length (in)	Actual Length	Watts			Nominal Length (in)	Actual Length	Watts			Nominal Length (in)	Actual Length	Watts		
		SO	HO	VHO			SO	HO	VHO			SO	HO	VHO			SO	HO	VHO
12	11 11/16	2.7	4.4	6.2	47	46 7/16	10.5	17.4	23.1	82	81 3/16	18.3	29.5	38.4	117	-	-	-	
13	12 14/16	2.9	4.8	6.7	48	47 10/16	10.7	17.8	23.5	83	82 5/16	18.5	29.8	38.8	118	117 1/16	26.1	41.1	52.8
14	-	-	-	-	49	48 12/16	11.1	18.6	24.4	84	83 8/16	18.7	30.1	39.2	119	118 4/16	26.3	41.4	53.2
15	14	3.1	5.2	7.3	50	49 15/16	11.4	18.9	24.9	85	84 10/16	19.2	30.8	40.0	120	119 6/16	26.5	41.7	53.6
16	15 3/16	3.4	5.6	7.8	51	-	-	-	-	86	85 13/16	19.4	31.1	40.4	121	120 9/16	26.7	42.0	54.0
17	16 5/16	3.6	6.0	8.3	52	51 1/16	11.6	19.3	25.3	87	87	19.6	31.5	40.8	122	121 11/16	27.1	42.6	54.7
18	17 8/16	3.9	6.5	8.9	53	52 4/16	11.9	19.7	25.7	88	-	-	-	-	123	122 14/16	27.3	42.9	55.0
19	18 10/16	4.4	7.3	9.9	54	53 6/16	12.1	20.1	26.1	89	88 2/16	19.9	31.8	41.1	124	-	-	-	
20	19 13/16	4.6	7.7	10.5	55	54 9/16	12.3	20.5	26.6	90	89 5/16	20.1	32.2	41.5	125	124	27.5	43.1	55.4
21	20 15/16	4.8	8.1	11.0	56	55 11/16	12.8	21.3	27.4	91	90 7/16	20.4	32.5	41.9	126	125 3/16	27.7	43.4	55.7
22	-	-	-	-	57	56 14/16	13.1	21.6	27.8	92	91 10/16	20.6	32.9	42.3	127	126 5/16	27.9	43.7	56.1
23	22 2/16	5.1	8.6	11.5	58	-	-	-	-	93	92 12/16	21.1	33.6	43.1	128	127 8/16	28.1	43.9	56.4
24	23 5/16	5.3	9.0	12.1	59	58	13.3	22.0	28.3	94	93 15/16	21.3	33.9	43.4	129	128 11/16	28.5	44.5	57.1
25	24 7/16	5.6	9.4	12.6	60	59 3/16	13.6	22.4	28.7	95	-	-	-	-	130	129 13/16	28.7	44.7	57.4
26	25 10/16	5.8	9.8	13.1	61	60 5/16	13.8	22.8	29.1	96	95 1/16	21.5	34.2	43.8	131	131	28.9	45.0	57.8
27	26 12/16	6.2	10.5	14.1	62	61 8/16	14.0	23.1	29.6	97	96 4/16	21.8	34.6	44.2	132	-	-	-	
28	27 15/16	6.5	10.9	14.5	63	62 10/16	14.5	23.8	30.5	98	97 6/16	22.0	34.9	44.6	133	132 2/16	29.1	45.3	58.1
29	-	-	-	-	64	63 13/16	14.7	24.1	31.0	99	98 9/16	22.2	35.2	45.0	134	133 5/16	29.3	45.5	58.4
30	29 1/16	6.7	11.2	15.0	65	65	14.9	24.4	31.4	100	99 11/16	22.5	35.9	45.9	135	134 7/16	29.5	45.7	58.7
31	30 4/16	6.9	11.6	15.5	66	-	-	-	-	101	100 14/16	22.7	36.2	46.3	136	135 10/16	29.6	45.9	59.1
32	31 6/16	7.1	12.0	16.0	67	66 2/16	15.1	24.7	31.9	102	-	-	-	-	137	136 12/16	30.0	46.3	59.7
33	32 9/16	7.3	12.3	16.5	68	67 5/16	15.3	25.0	32.4	103	102	22.9	36.5	46.7	138	137 15/16	30.2	46.5	60.0
34	33 11/16	7.8	13.1	17.4	69	68 7/16	15.5	25.4	32.8	104	103 3/16	23.1	36.8	47.1	139	-	-	-	
35	34 14/16	8.0	13.4	17.9	70	69 10/16	15.8	25.7	33.3	105	104 5/16	23.3	37.1	47.5	140	139 1/16	30.3	46.8	60.3
36	-	-	-	-	71	70 12/16	16.2	26.3	34.2	106	105 8/16	23.5	37.4	48.0	141	140 4/16	30.5	47.0	60.6
37	36	8.2	13.8	18.4	72	71 15/16	16.4	26.6	34.7	107	106 10/16	23.9	38.1	48.8	142	141 6/16	30.7	47.2	61.0
38	37 3/16	8.4	14.2	18.9	73	-	-	-	-	108	107 13/16	24.1	38.4	49.2	143	142 9/16	30.8	47.4	61.3
39	38 5/16	8.7	14.5	19.3	74	73 1/16	16.6	26.9	35.1	109	109	24.3	38.7	49.6	144	143 11/16	31.2	47.8	61.9
40	39 8/16	8.9	14.9	19.8	75	74 4/16	16.8	27.3	35.5	110	-	-	-	-					
41	40 10/16	9.3	15.6	20.7	76	75 6/16	17.1	27.6	35.9	111	110 2/16	24.5	39.0	50.0					
42	41 13/16	9.6	16.0	21.2	77	76 9/16	17.3	27.9	36.3	112	111 5/16	24.8	39.3	50.4					
43	43	9.8	16.4	21.7	78	77 11/16	17.7	28.5	37.2	113	112 7/16	25.0	39.6	50.8					
44	-	-	-	-	79	78 14/16	17.9	28.9	37.6	114	113 10/16	25.2	39.9	51.2					
45	44 2/16	10.0	16.7	22.1	80	-	-	-	-	115	114 12/16	25.6	40.5	52.0					
46	45 5/16	10.2	17.1	22.6	81	80	18.1	29.2	38.0	116	115 15/16	25.9	40.8	52.4					

Power Consumption

Tested at Full Power with PS-UNI Series power supplies.

Standard Nominal Lengths offered provide minimal shadowing. For alternate lengths, please consult Inside Sales with specific request.

High Efficacy (HE48)

Nominal Length (in)	Actual Length	Watts				Nominal Length (in)	Actual Length	Watts				Nominal Length (in)	Actual Length	Watts				Nominal Length (in)	Actual Length	Watts			
		LO	SO	MO	HO			LO	SO	MO	HO			LO	SO	MO	HO			LO	SO	MO	HO
12	11 15/16	1.7	2.5	3.5	5.7	47	-	-	-	-	82	-	-	-	-	118	116 4/16	17.5	27.7	34.3	58.7		
13	-	-	-	-	-	48	47 6/16	7.1	11.2	13.9	25.4	83	82 13/16	12.8	20.3	24.5	43.1	118	-	-	-	-	
14	13 14/16	2.0	3.0	4.0	7.2	49	-	-	-	-	84	-	-	-	-	119	118 4/16	17.8	28.1	34.9	59.6		
15	-	-	-	-	-	50	49 5/16	7.4	11.7	14.5	26.3	85	84 12/16	13.1	20.8	25.1	44.1	120	-	-	-	-	
16	15 14/16	2.4	3.5	4.6	8.7	51	-	-	-	-	86	-	-	-	-	121	120 3/16	18.1	28.6	35.5	60.5		
17	-	-	-	-	-	52	51 5/16	7.7	12.3	15.1	27.4	87	86 12/16	13.4	21.3	25.7	45.0	122	-	-	-	-	
18	17 13/16	2.7	3.9	5.2	10.2	53	-	-	-	-	88	-	-	-	-	123	122 3/16	18.3	29.0	36.0	62.1		
19	-	-	-	-	-	54	53 4/16	8.0	12.9	15.7	28.5	89	88 11/16	13.7	21.7	26.3	46.0	124	-	-	-	-	
20	19 13/16	3.0	4.4	5.8	11.7	55	-	-	-	-	90	-	-	-	-	125	124 2/16	18.4	29.5	36.6	63.8		
21	-	-	-	-	-	56	55 4/16	8.4	13.5	16.4	29.5	91	90 11/16	14.0	22.1	26.9	47.0	126	-	-	-	-	
22	21 12/16	3.4	4.9	6.4	13.2	57	-	-	-	-	92	-	-	-	-	127	126 2/16	18.6	29.9	37.2	65.4		
23	-	-	-	-	-	58	57 3/16	8.7	14.0	17.0	30.6	93	92 10/16	14.3	22.6	27.5	47.9	128	-	-	-	-	
24	23 12/16	3.7	5.4	7.0	14.7	59	-	-	-	-	94	-	-	-	-	129	128 1/16	18.8	30.4	37.7	67.0		
25	-	-	-	-	-	60	59 3/16	9.0	14.6	17.6	31.6	95	94 10/16	14.4	22.8	27.8	48.4	130	-	-	-	-	
26	25 11/16	4.1	5.9	7.5	15.8	61	-	-	-	-	96	-	-	-	-	131	130 1/16	18.9	30.8	38.3	68.6		
27	-	-	-	-	-	62	61 2/16	9.4	15.2	18.2	32.6	97	96 9/16	14.7	23.3	28.5	49.4	132	-	-	-	-	
28	27 11/16	4.4	6.4	8.1	16.8	63	-	-	-	-	98	-	-	-	-	133	132	19.1	31.2	38.9	70.2		
29	-	-	-	-	-	64	63 2/16	9.7	15.6	18.7	33.7	99	98 9/16	15.0	23.7	29.0	50.4	134	134	19.3	31.8	39.4	70.7
30	29 10/16	4.8	6.9	8.7	17.9	65	-	-	-	-	100	-	-	-	-	135	-	-	-	-	-		
31	-	-	-	-	-	66	65 1/16	10.0	16.1	19.2	34.7	101	100 8/16	15.3	24.1	29.6	51.3	136	135 15/16	19.5	32.3	40.0	71.2
32	31 10/16	5.0	7.2	9.0	18.5	67	-	-	-	-	102	-	-	-	-	137	-	-	-	-	-		
33	-	-	-	-	-	68	67 1/16	10.4	16.5	19.8	35.7	103	102 8/16	15.6	24.6	30.2	52.3	138	137 15/16	19.8	32.8	40.6	71.8
34	33 9/16	5.4	7.7	9.6	19.5	69	-	-	-	-	104	-	-	-	-	139	-	-	-	-	-		
35	-	-	-	-	-	70	69	10.7	17.0	20.3	36.7	105	104 7/16	15.8	25.0	30.7	53.2	140	139 14/16	20.0	33.3	41.1	72.3
36	35 9/16	5.7	8.2	10.2	20.6	71	71	11.0	17.4	20.8	37.7	106	-	-	-	-	141	-	-	-	-	-	
37	-	-	-	-	-	72	-	-	-	-	107	106 7/16	16.1	25.5	31.3	54.2	142	141 14/16	20.2	33.9	41.7	72.8	
38	37 8/16	6.0	8.7	10.8	21.5	73	72 15/16	11.3	17.9	21.4	38.7	108	-	-	-	-	143	-	-	-	-	-	
39	-	-	-	-	-	74	-	-	-	-	109	108 6/16	16.4	25.9	31.9	55.2	144	143 13/16	20.4	34.4	42.3	73.4	
40	39 8/16	6.2	9.2	11.4	22.3	75	74 15/16	11.6	18.4	22.0	39.6	110	-	-	-	-	-	-	-	-	-	-	
41	-	-	-	-	-	76	-	-	-	-	111	110 6/16	16.7	26.4	32.5	56.1	-	-	-	-	-	-	
42	41 7/16	6.4	9.7	12.0	23.1	77	76 14/16	11.9	18.9	22.7	40.5	112	-	-	-	-	-	-	-	-	-	-	
43	-	-	-	-	-	78	-	-	-	-	113	112 5/16	17.0	26.8	33.1	57.0	-	-	-	-	-	-	
44	43 7/16	6.7	10.2	12.6	23.9	79	78 14/16	12.2	19.4	23.3	41.4	114	-	-	-	-	-	-	-	-	-	-	
45	-	-	-	-	-	80	-	-	-	-	115	114 5/16	17.3	27.3	33.7	57.9	-	-	-	-	-	-	
46	45 6/16	6.9	10.7	13.3	24.7	81	80 13/16	12.5	19.9	23.9	42.2	116	-	-	-	-	-	-	-	-	-	-	

Power Consumption

Tested at Full Power with PS-UNI Series power supplies.

Standard Nominal Lengths offered provide minimal shadowing. For alternate lengths, please consult Inside Sales with specific request.

High Efficacy (HE64)

Nominal Length (in)	Actual Length	Watts		Nominal Length (in)	Actual Length	Watts		Nominal Length (in)	Actual Length	Watts		Nominal Length (in)	Actual Length	Watts	
		VHO	XHO			VHO	XHO			VHO	XHO			VHO	XHO
12	10 12/16	7.6	9.7	47	–	–	–	82	81 14/16	51.7	63.4	117	116 12/16	72.8	80.7
13	12 4/16	7.6	9.7	48	47 1/16	29.5	37.6	83	–	–	–	118	–	–	–
14	13 12/16	8.9	11.3	49	48 9/16	30.1	38.4	84	83 7/16	52.3	63.8	119	118 4/16	73.3	81.0
15	–	–	–	50	–	–	–	85	84 15/16	53.6	64.7	120	119 12/16	74.4	81.7
16	15 4/16	9.5	12.1	51	50 2/16	31.4	40.2	86	–	–	–	121	–	–	–
17	16 13/16	10.7	13.6	52	51 10/16	32.0	41.1	87	86 7/16	54.2	65.3	122	121 4/16	74.8	82.0
18	–	–	–	53	–	–	–	88	87 15/16	55.5	66.3	123	122 12/16	75.6	82.5
19	18 5/16	11.4	14.4	54	53 2/16	33.3	42.9	89	–	–	–	124	–	–	–
20	19 13/16	12.6	16.0	55	54 10/16	34.0	43.8	90	89 7/16	56.2	66.8	125	124 5/16	76.0	82.8
21	–	–	–	56	–	–	–	91	91	57.5	67.9	126	125 13/16	76.8	83.4
22	21 5/16	13.2	16.8	57	56 2/16	35.2	45.5	92	–	–	–	127	–	–	–
23	22 13/16	14.5	18.3	58	57 11/16	36.5	47.3	93	92 8/16	58.2	68.4	128	127 5/16	77.2	83.6
24	–	–	–	59	–	–	–	94	–	–	–	129	128 13/16	78.0	84.2
25	24 6/16	15.1	19.1	60	59 3/16	37.2	48.2	95	94	59.5	69.5	130	–	–	–
26	25 14/16	16.4	20.7	61	60 11/16	38.4	50.0	96	95 8/16	60.1	70.0	131	130 6/16	78.4	84.5
27	–	–	–	62	–	–	–	97	–	–	–	132	131 14/16	79.2	85.0
28	27 6/16	17.0	21.4	63	62 3/16	39.1	50.8	98	97 1/16	61.4	71.1	133	–	–	–
29	28 14/16	18.2	23.0	64	63 12/16	40.4	52.5	99	98 9/16	62.0	71.7	134	133 6/16	79.6	85.4
30	–	–	–	65	–	–	–	100	–	–	–	135	134 14/16	80.3	86.2
31	30 7/16	18.9	23.8	66	65 4/16	41.0	53.4	101	100 1/16	63.2	72.9	136	–	–	–
32	31 15/16	20.1	25.3	67	66 12/16	42.3	55.1	102	101 9/16	63.8	73.5	137	136 6/16	80.6	86.6
33	–	–	–	68	–	–	–	103	–	–	–	138	137 15/16	81.3	87.5
34	33 7/16	20.7	26.1	69	68 4/16	42.9	55.9	104	103 1/16	65.0	74.7	139	–	–	–
35	34 15/16	22.0	27.6	70	69 12/16	44.2	57.6	105	104 10/16	65.6	75.3	140	139 7/16	81.7	87.9
36	–	–	–	71	–	–	–	106	–	–	–	141	140 15/16	82.4	88.7
37	36 7/16	22.6	28.4	72	71 5/16	44.9	58.5	107	106 2/16	66.8	76.5	142	–	–	–
38	38	23.9	30.1	73	72 13/16	46.1	59.7	108	107 10/16	67.4	77.1	143	142 7/16	82.7	89.1
39	–	–	–	74	–	–	–	109	–	–	–	144	144	83.4	89.9
40	39 8/16	24.5	30.9	75	74 5/16	46.7	60.1	110	109 2/16	68.5	78.0				
41	–	–	–	76	75 13/16	48.0	60.9	111	110 11/16	69.6	78.7				
42	41	25.7	32.6	77	–	–	–	112	–	–	–				
43	42 8/16	26.4	33.4	78	77 6/16	48.6	61.3	113	112 3/16	70.1	79.0				
44	–	–	–	79	78 14/16	49.8	62.2	114	113 11/16	71.2	79.7				
45	44 1/16	27.6	35.1	80	–	–	–	115	–	–	–				
46	45 9/16	28.2	35.9	81	80 6/16	50.4	62.6	116	115 3/16	71.7	80.0				

Voltage Drop Calculator

The below chart assumes nominal voltage of 24 Volts and a Voltage Drop Allowance of 3% through the wire

Wattage [W]	Wire Length From Power Supply to Start of Run [ft]						
	12 AWG	14 AWG	16 AWG	18 AWG	20 AWG	22 AWG	24 AWG
5	1088.2	684.4	430.3	270.6	170.2	107.1	67.3
10	544.1	342.2	215.1	135.3	85.1	53.5	33.7
15	362.7	228.1	143.4	90.2	56.7	35.7	22.4
20	272.0	171.1	107.6	67.7	42.6	26.8	16.8
25	217.6	136.9	86.1	54.1	34.0	21.4	13.5
30	181.4	114.1	71.7	45.1	28.4	17.8	11.2
35	155.5	97.8	61.5	38.7	24.3	15.3	9.6
40	136.0	85.5	53.8	33.8	21.3	13.4	8.4
45	120.9	76.0	47.8	30.1	18.9	11.9	7.5
50	108.8	68.4	43.0	27.1	17.0	10.7	6.7
55	98.9	62.2	39.1	24.6	15.5	9.7	6.1
60	90.7	57.0	35.9	22.6	14.2	8.9	5.6
65	83.7	52.6	33.1	20.8	13.1	8.2	5.2
70	77.7	48.9	30.7	19.3	12.2	7.6	4.8
75	72.5	45.6	28.7	18.0	11.3	7.1	4.5
80	68.0	42.8	26.9	16.9	10.6	6.7	4.2
85	64.0	40.3	25.3	15.9	10.0	6.3	4.0
90	60.5	38.0	23.9	15.0	9.5	5.9	3.7
96	56.7	35.6	22.4	14.1	8.9	5.6	3.5

Power Supplies

See Power Supply instructions and spec sheet for wiring information. For a complete list of compatible dimmers, see Compatible Dimming Chart on the Resources page.

Ordering Code Universal Dimming Power Supplies 1% 120VAC - 277VAC

MODEL	INPUT CONTROL	ENVIRONMENT	WATTAGE	OUTPUT
PS-Power Supply, 120-277VAC	UNI-0-10V Dimming, Phase Dimming	D-Dry W-Wet	30-30 Watts 60-60 Watts 96-96 Watts 3x96-3x96 Watts	24-24 VDC

Compatibility: View a complete list of compatible dimmers on product page [\(Link\)](#)

0-10V - 1% dimming
MLV/ELV/TRIAC - 1% dimming, consult dimming compatibility chart

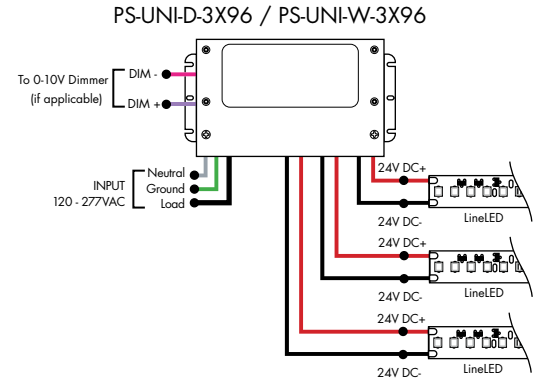
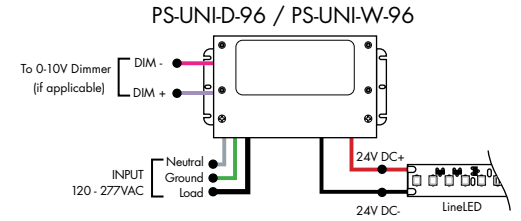

MODELS	PS-UNI-W-30W	PS-UNI-W-60W	PS-UNI-W-96W	PS-UNI-W-3X96W
Length	6.50"	7.40"	8.66"	11.85"
Width	3.73"	3.73"	3.73"	4.32"
Depth	1.61"	1.61"	1.61"	1.81"

MODELS	PS-UNI-D-30W	PS-UNI-D-60W	PS-UNI-D-96W	PS-UNI-D-3X96W
Length	8.77"	8.77"	8.11"	9.94"
Width	4.27"	4.27"	5.60"	7.61"
Depth	1.83"	1.83"	1.83"	2.02"

Ordering Code 0-10V Dimming Power Supplies 0.1% 120VAC - 277VAC

MODEL	INPUT CONTROL	ENVIRONMENT	WATTAGE	OUTPUT
PS-Power Supply, 120-277VAC	010V-LIN-0-10V Dimming (0.1%), Linear 010V-LOG-0-10V Dimming (0.1%), Logarithmic	D-Dry	96-96 Watts 3X96-3x96 Watts	24-24 VDC

MODELS	96W	3X96
Length	14.40"	15.00"
Width	5.20"	6.62"
Depth	2.60"	4.45"

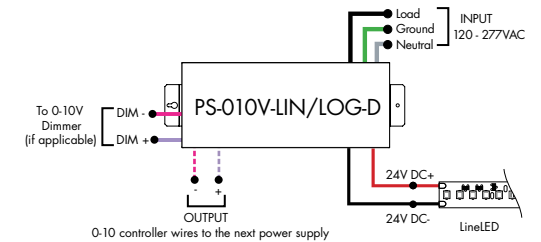
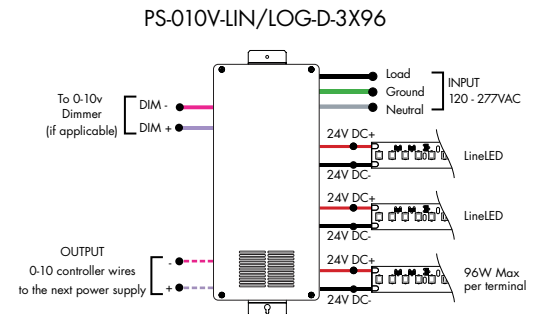

Athena 0-10V LED Driver

MODEL	INPUT CONTROL	ENVIRONMENT	WATTAGE	OUTPUT	FEATURE
PS-Power Supply, 120-277VAC	010V-LIN-0-10V Dimming, Linear 010V-LOG-0-10V Dimming, Logarithmic	D-Dry	96-96 W	24-24 VDC	AWNR-Athena

MODELS	96W
Length	14.40"
Width	5.20"
Depth	2.60"

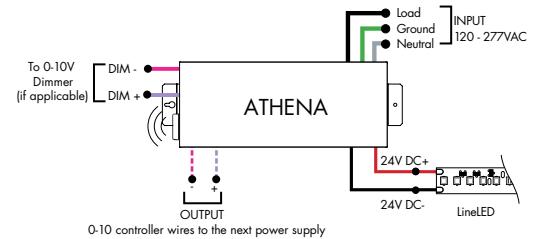

Power Supplies

See Power Supply instructions and spec sheet for wiring information. For a complete list of compatible dimmers, see Compatible Dimming Chart on the Resources page.

Ordering Code DALI1 Dimming Power Supplies 0.1% 120VAC - 277VAC

MODEL	INPUT CONTROL	ENVIRONMENT	WATTAGE	OUTPUT
PS-Power Supply, 120-277VAC	DALI-DALI (0.1%)	D-Dry	96-96 Watts 3X96-3X96 Watts	24-24 VDC

Model	96W	3X96
Length	14.40"	15.00"
Width	5.20"	6.62"
Depth	2.60"	4.56"

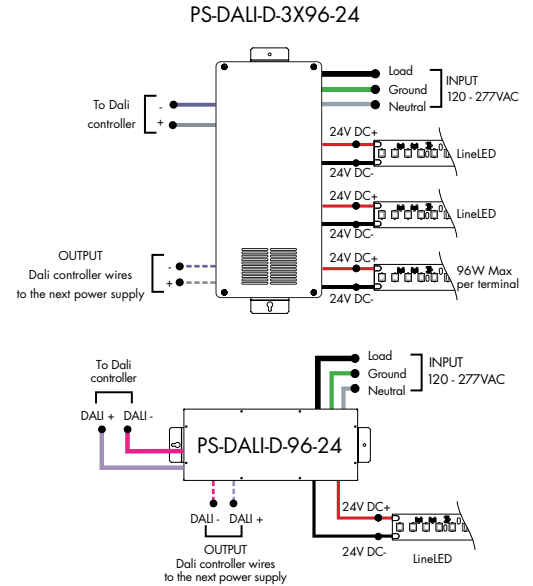

Ordering Code DMX Dimming Power Supplies 0.1% 120VAC - 277VAC Requires Zonal Control

MODEL	INPUT CONTROL	ENVIRONMENT	WATTAGE	OUTPUT
PS-Power Supply, 120-277VAC	DMX-DMX (0.1%)	D-Dry	96-96 Watts 3X96-3X96 Watts	24-24 VDC

*Zonal control power supplies. Control multiple tapes/zones using DMX channels.

MODELS	96W	3X96
Length	14.40"	15.00"
Width	5.20"	6.62"
Depth	2.60"	4.56"

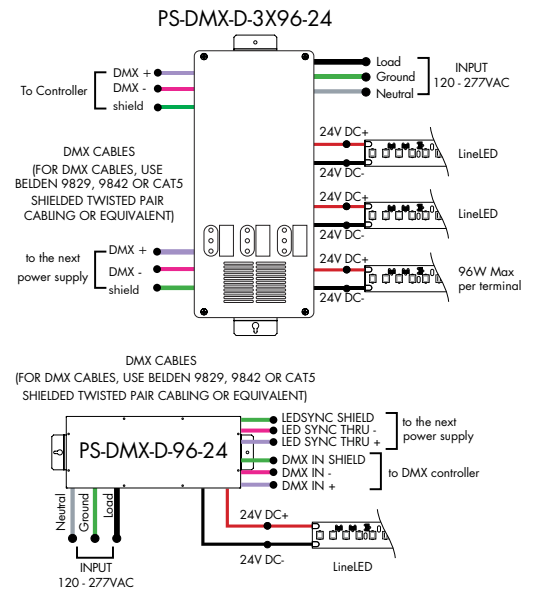

Ordering Code Enlightened Enabled Dimming Power Supplies 1% 120VAC - 277VAC

MODEL	INPUT CONTROL	ENVIRONMENT	WATTAGE	OUTPUT	FEATURE
PS-Power Supply, 120-277VAC	010V-0-10V Dimming (1%)	D-Dry	96-96 Watts	24-24 VDC	ENL-0-10V Enlightened

Model	96W
Length	14.40"
Width	5.20"
Depth	2.60"

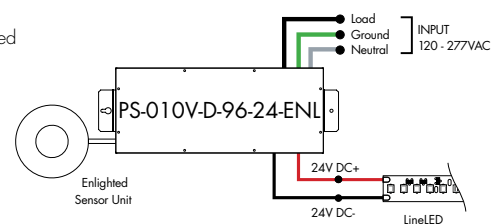

Power Supplies

See Power Supply instructions and spec sheet for wiring information. For a complete list of compatible dimmers, see Compatible Dimming Chart on the Resources page.

Ordering Code Non-Dimming Power Supply 120VAC - 277VAC

MODEL	INPUT CONTROL	ENVIRONMENT	WATTAGE	OUTPUT
PS - Power Supply, 120-277VAC	ND - Non Dimming	D - Dry	96-96 Watts	24 - 24 VDC

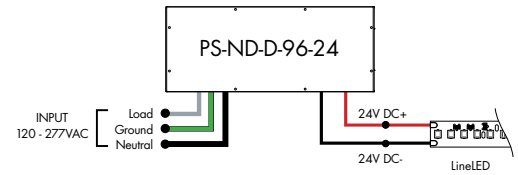

MODELS	96W
Length	14.40"
Width	5.20"
Depth	2.60"

Ordering Code Phase Dimming Power Supply 1% 120VAC - 277VAC

MODEL	INPUT CONTROL	ENVIRONMENT	WATTAGE	OUTPUT	OUTPUT CONTROL
PS - Power Supply, 120-277VAC	PH - Phase Dimming (Triac, ELV, MLV)	D - Dry	96 - 96 Watts	24 - 24 VDC	DC - Direct Current

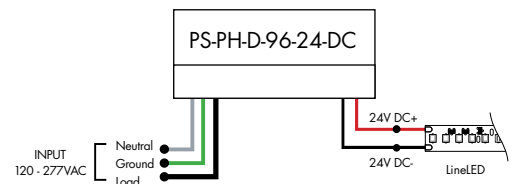

MLV/ELV/TRIAC - 1% dimming, consult dimming compatibility chart ([Link](#))

NOTE:
OVER THE WHITE, GREEN, AND BLACK WIRES,
CONNECT TO ELV OR MLV DIMMER

MODELS	96W
Length	8.25"
Width	4.10"
Depth	1.56"

Ordering Code In-Ground Power Supplies

MODEL	INPUT CONTROL	ENVIRONMENT	WATTAGE	OUTPUT
PS120 - Power Supply, 120VAC PS240 - Power Supply, 240VAC PS277 - Power Supply, 277VAC	ELV - ELV Dimming (1%)	IG - In Ground	2X96 - 2X96 Watts	24 - 24 VDC

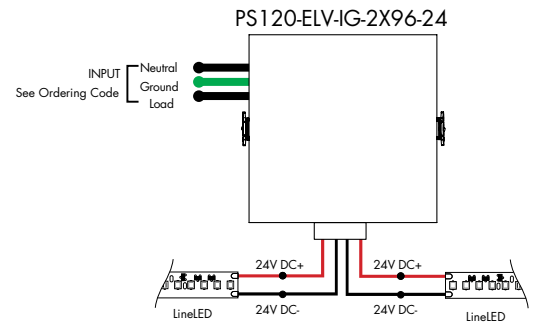

MODELS	2X96W
Length	8.40"
Width	8.30"
Depth	8.10"

Power Supplies

See Power Supply instructions and spec sheet for wiring information. For a complete list of compatible dimmers, see Compatible Dimming Chart on the Resources page.



Luminii is a Lutron OEM Advantage Partner
Lutron Power Supplies 1%

MODEL

L3DA4U1UKL-CV240

HiLume™ 1% EcoSystem Voltage LED driver
 40W max

MODELS	L3DA4U1UKL-CV240
Length	4.98"
Width	4.00"
Depth	2.62"

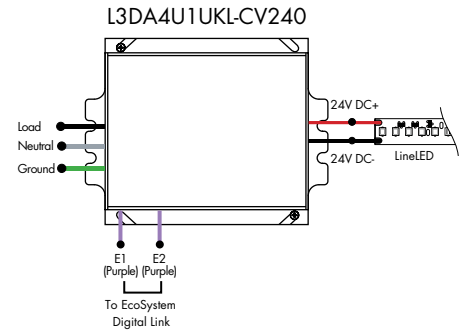

Luminii is a Lutron OEM Advantage Partner
Lutron Power Supplies 0.1%

MODEL

L3D0-96W24V-U

HiLume™ 0.1% EcoSystem Voltage LED Driver with Soft-On, Fade-to-Black™
 96W max

MODELS	L3D0
Length	10.50"
Width	5.50"
Depth	2.00"

