

LETO 44 MINI

WALL MOUNT CYLINDER
TUNABLE WHITE & WARM DIM



Features

- Faceted metal reflectors provide beam spreads between 20° to 60°.
- Three output options available up to 1500 lumens.
- Nine drivers selections available to cover wide range of applications.
- Five year warranty.

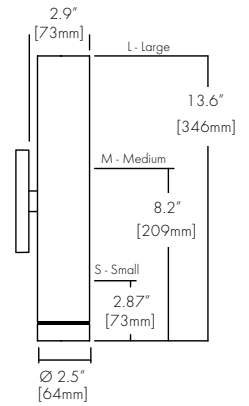

Finish Options

- White
- Silver
- Mocha
- Firebrick
- Warm Nickel
- Black
- Charcoal
- Cerulean
- Bronze
- Aged Brass

Technical Information

| TYPE | WD1830 | | TW2765 |
|---|----------------|---------------|---------------|
| OUTPUT OPTIONS | 700 lm (S/M/L) | 1000 lm (M/L) | 1500 lm (M/L) |
| Fixture wattage | 7.2 W | 11.4 W | 16.5 W |
| Delivered Lumen | 819 lm | 1288 lm | 1617 lm |
| Efficacy | 114 lm/W | 113 lm/W | 98 lm/W |
| Center Beam Candlepower (20° Faceted Reflector) | 1689 cd | 2680 cd | 3464 cd |

| CCT | CRI | TM-30 | | |
|-------|-----|----------------|----------------|----------------|
| | | R _f | R _g | R ₉ |
| 1800K | 94 | 90 | 93 | 61 |
| 3000K | 94 | 89 | 97 | 72 |
| 2700K | 91 | 90 | 96 | 59 |
| 6500K | 93 | 87 | 97 | 73 |

Ordering Code

Integral Driver Example: Fixture LET11M-WM-S-07-WD1830-F20-NA-WH-WH-RDS-WH-PHSD-NA

Remote Driver Example: Fixture LET11M-WM-S-07-WD1830-F20-NA-WH-WH-RDS-WH-PHSD-NA-HRM-LET11M-WM-07-WD1830-PHSD-NA

Fixture

| MODEL | TYPE | SIZE | OUTPUT | CCT | OPTIC | ACCESSORY | BODY FINISH | BAFFLE FINISH |
|---------------------|---------------|----------------------|--|--|--|--|--|--|
| LET44M-Leto 44 Mini | WM-Wall Mount | S-Small ⁴ | 07-700 lumens (7.2W) | WD1830-Warm Dim, 1800K-3000K | F20-20 Degree, Faceted F30-30 Degree, Faceted F60-60 Degree, Faceted | NA-No Accessory DL-Diffusing Lens HC-Honeycomb Louver ⁴ | Standard WH-White BK-Black S-Silver Premium ³ MA-Mocha CC-Charcoal CR-Cerulean FB-Firebrick BZ-Bronze WN-Warm Nickel AB-Aged Brass | Standard WH-White BK-Black S-Silver Premium ³ MA-Mocha CC-Charcoal CR-Cerulean FB-Firebrick BZ-Bronze WN-Warm Nickel AB-Aged Brass |
| | | M-Medium L-Large | 07-700 lumens (7.2W) 10-1000 lumens (11.4W) | WD1830-Warm Dim, 1800K-3000K | | | | |
| | | M-Medium L-Large | 15-1500 lumens (16.5W) | TW2765-Tunable White, 2700K-6500K ^{1,2} | | | | |

| CANOPY/ HOUSING | CANOPY FINISH | DRIVER | DRIVER OPTIONS ⁸ |
|--|--|--|--|
| RDS-Round Slim SQS-Square Slim SQR-Square Semi-Recessed ⁵ | Standard WH-White BK-Black S-Silver Premium ³ MA-Mocha CC-Charcoal CR-Cerulean FB-Firebrick BZ-Bronze WN-Warm Nickel AB-Aged Brass | PHSD-Forward/Reverse Phase, 1% Dimming, 120V Only 010S-0-10V, 1% Dimming, 120/277V 0103-0-10V, 1% Dimming, 347V Only ⁷ 010L-EldoLED, 0-10V, Linear, 0.1% Dimming, 120/277V ⁷ 010G-EldoLED, 0-10V, Log, 0.1% Dimming, 120/277V ⁷ DALI-EldoLED, DALI Protocol 2, DT-6, 0.1% Dimming, 120/277V ⁷ DALI8-EldoLED, DALI Protocol 2, DT-8, 0.1% Dimming, 120/277V ⁷ LUTE-Lutron Hilume Ecodigital, 1% Dimming, 120V/277V ^{6,7} DMX-EldoLED, DMX, 0.1% Dimming, 120V/277V ⁷ | NA-None EMG-Emergency Driver ⁸ |

1 - TW2765 only available with Drivers 010L/010G/DALI8/DMX. Not available with EMG driver option.
2 - TW2765 requires HRM - Remote Power Supply.
3 - Premium finishes may have extended lead times. Custom RALs are available, please consult Inside Sales with specific request.
4 - Size Small is not available with accessory HC Honeycomb.
5 - SQR Canopy with PHSD/010S is not available with 700 lumens.
6 - LUTE driver is not available at 700 lumens.

7 - Drivers 0103/010L/010G/DALI/DALI8/DMX/LUTE/EMG are only available with HRM - Remote Power Supply.
8 - Emergency option comes prewired from factory with driver in remote housing. 8V of continuous power provided for a minimum of 90 minutes. Must be installed within 30 feet of luminaire using 18 AWG wire. Not available with 0103, DMX, DALI8 or LUTE Driver.
9 - AAVNR/CSMB available upon request.

CONTACT FACTORY FOR MORE OPTIONS.

LETO 44 MINI

WALL MOUNT CYLINDER
TUNABLE WHITE & WARM DIM

Canopy

RDS
Round Slim Canopy

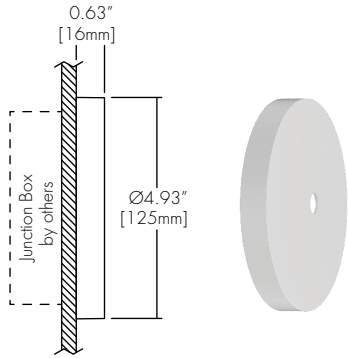

SQS
Square Slim Canopy

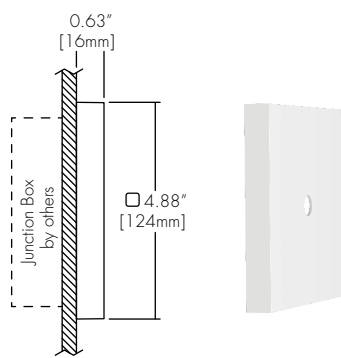

SQR
Square Semi-Recessed

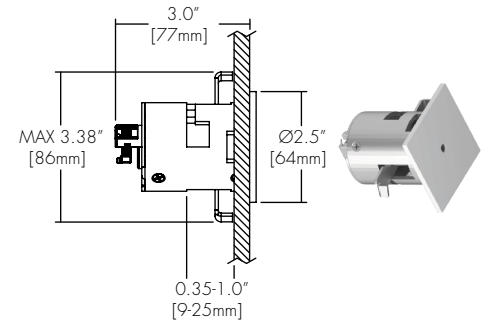

| RDS or SQS | |
|------------------|--|
| Integral Drivers | PHSD, 010S |
| Remote Drivers | 0103, 010L, 010G, DALI, DALI8, LUTE, DMX |

| SQR | |
|------------------|--|
| Integral Drivers | |
| Remote Drivers | PHSD, 010S, 0103, 010L, 010G, DALI, DALI8, LUTE, DMX |

Lens & Accessory Options

DL
Diffusing Lens



HC
Honeycomb



Optics

FXX (20°, 30°, 60°)
Faceted Reflector



LETO 44 MINI

WALL MOUNT CYLINDER
TUNABLE WHITE & WARM DIM

Remote Driver Housing

Depending on the options selected in the order code on page 1, a Remote Driver Housing may be required. This will automatically be generated and put on your order as necessary.

| REMOTE DRIVER | MODEL | OUTPUT | CCT | DRIVER | DRIVER OPTIONS |
|---------------------|-----------------------------------|-----------------|-----------------|-----------------|-----------------|
| HRM-Housing, Remote | LET44M-WM-Leto 44 Mini Wall Mount | Same as Fixture | Same as Fixture | Same as Fixture | Same as Fixture |

| Maximum mounting distance to luminaire using 18 AWG wire | | | | | | | | |
|--|------|------|------|------|------|-------|------|------|
| PHSD | 010S | 0103 | 010L | 010G | DALI | DALI8 | LUTE | DMX |
| 16' | 16' | 16' | 72' | 72' | 72' | 72' | 15' | 149' |

4" J-box

Minimum volume required to mount drivers in junction box: 70mm x 40mm x 30mm.

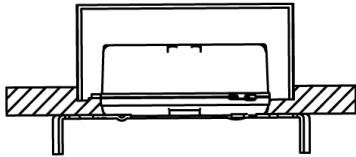

| Canopy | + | Driver |
|--------|---|--------|
| RDS | + | PHSD |
| RDS | + | 010S |
| SQS | + | PHSD |
| SQS | + | 010S |

HRM Single with Externally Mounted Driver

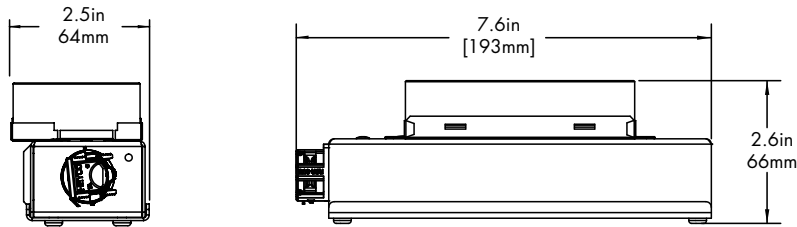

| Driver |
|--------|
| 0103 |
| 010L |
| 010G |
| 010S |
| DALI |
| LUTE |

HRM Double

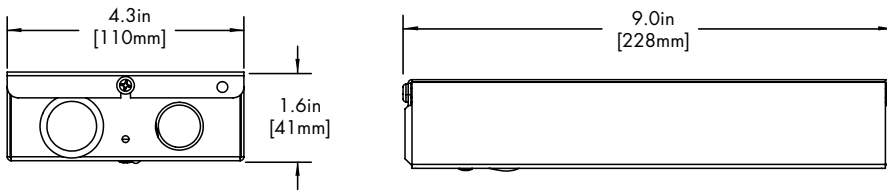

| Driver |
|--------|
| DALI8 |
| DMX |

EMG Emergency Driver

120 minute EMG operation time.

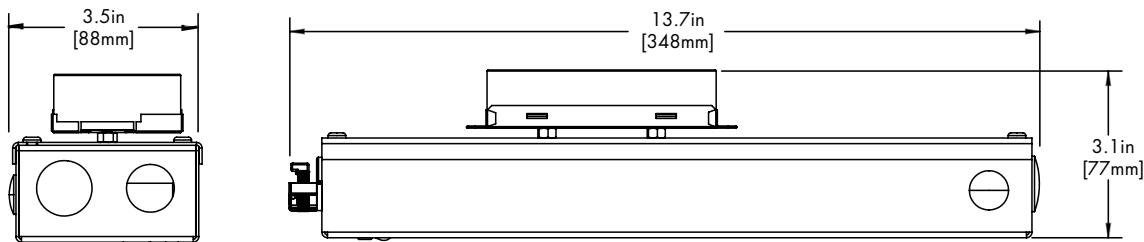

| Driver |
|--------|
| EMG |

LETO 44 MINI

WALL MOUNT CYLINDER
TUNABLE WHITE & WARM DIM

Standard Finishes

BK
Black



WH
White



SL
Silver



Premium Finishes

MA
Mocha



CC
Charcoal



CR
Cerulean

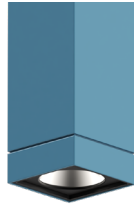

FB
Firebrick

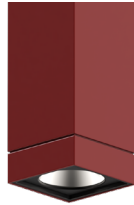

BZ
Bronze



WN
Warm Nickle



AB
Antique Bronze

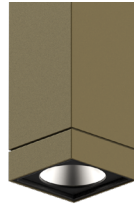

LETO 44 MINI

WALL MOUNT CYLINDER
TUNABLE WHITE & WARM DIM

TM-30

Warm Dim 1800K

COLOR VECTOR GRAPHIC

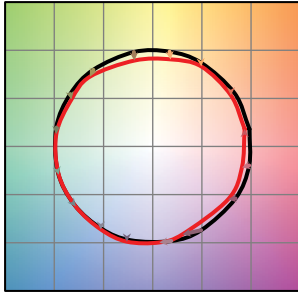

— Reference Source — Test Source

Warm Dim 3000K

COLOR VECTOR GRAPHIC

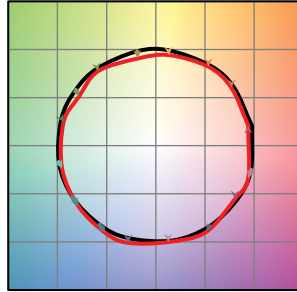

— Reference Source — Test Source

Tunable White 2700K

COLOR VECTOR GRAPHIC

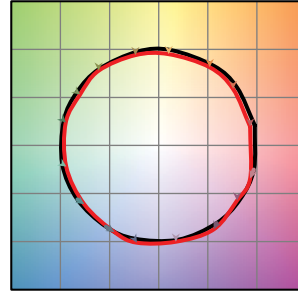

— Reference Source — Test Source

Tunable White 6500K

COLOR VECTOR GRAPHIC

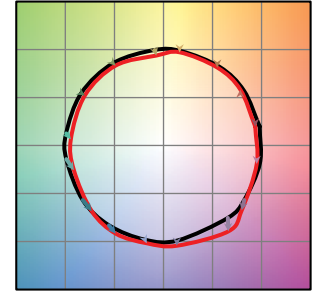

— Reference Source — Test Source

Photometry

20° Faceted Reflector

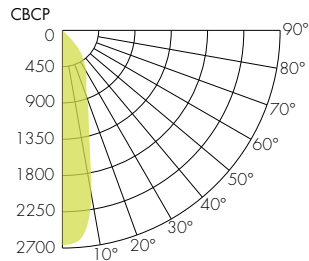
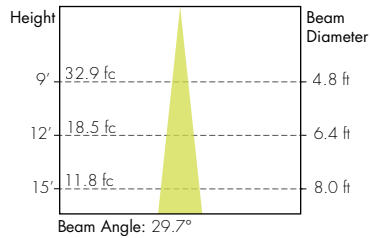

30° Faceted Reflector

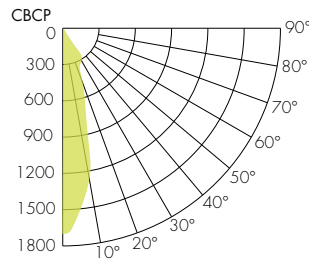
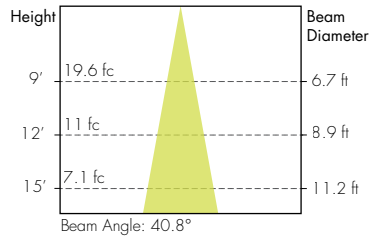

60° Faceted Reflector

