

LETO 44 MINI

MONO POINT CYLINDER

WARM DIM



Features

- Faceted metal reflectors provide beam spreads between 20° to 60°.
- Output available up to 1000 lumens.
- Nine drivers selections available to cover wide range of applications.
- Five year warranty.

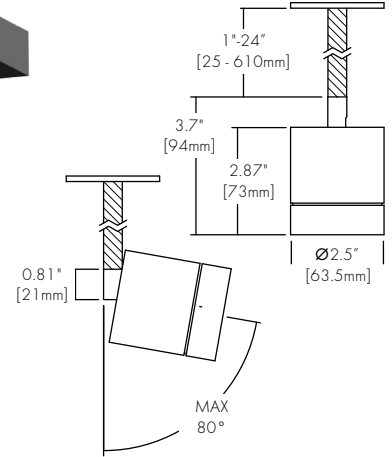

Finish Options

- White
- Silver
- Mocha
- Firebrick
- Warm Nickel
- Black
- Charcoal
- Cerulean
- Bronze
- Aged Brass

Technical Information

TYPE	WD1830	TM-30				
OUTPUT OPTIONS	700 lm (S)	CCT	CRI	R_f	R_g	R₉
Fixture wattage	7.2 W	1800K	94	90	93	61
Delivered Lumen	819 lm	3000K	94	89	97	72
Efficacy	114 lm/W					
Center Beam Candlepower (20° Faceted Reflector)	1517 cd					

Ordering Code

Integral Driver Example: Fixture LET44M-MP-S-07-WD1830-F20-NA-WH-WH-RDS-WH-SS01-WH-PHSD-NA

Remote Driver Example: Fixture LET11M-MP-S-07-WD1830-F20-NA-WH-WH-RDS-WH-SS01-WH-PHSD-NA-HRM-LET11M-MP-07-WD1830-PHSD-NA

Fixture

MODEL	TYPE	SIZE	OUTPUT	CCT	OPTIC	ACCESSORY	BODY FINISH	BAFFLE FINISH
LET11M-Leto 11 Mini	MP-Mono Point	S-Small	07-700 lumens (7.2W) ²	WD1830-Warm Dim, 1800K-3000K	F20-20 Degree, Faceted F30-30 Degree, Faceted F60-60 Degree, Faceted	NA-No Accessory DL-Diffusing Lens	Standard WH-White BK-Black S-Silver Premium ¹ MA-Mocha CC-Charcoal CR-Cerulean FB-Firebrick BZ-Bronze WN-Warm Nickel AB-Aged Brass	Standard WH-White BK-Black S-Silver Premium ¹ MA-Mocha CC-Charcoal CR-Cerulean FB-Firebrick BZ-Bronze WN-Warm Nickel AB-Aged Brass

CANOPY/ HOUSING	CANOPY FINISH	SUSPENSION TYPE	SUSPENSION FINISH	DRIVER	DRIVER OPTIONS ⁵
RDS-Round Slim SQS-Square Slim RTL-Round Flangeless SQR-Square Semi-Recessed ⁶	Standard WH-White BK-Black S-Silver Premium ¹ MA-Mocha CC-Charcoal CR-Cerulean FB-Firebrick BZ-Bronze WN-Warm Nickel AB-Aged Brass	SS01-Solid Stem, 1" SS06-Solid Stem, 6" SS1-Solid Stem, 12" SS2-Solid Stem, 24"	Standard WH-White BK-Black S-Silver Premium ¹ MA-Mocha CC-Charcoal CR-Cerulean FB-Firebrick BZ-Bronze WN-Warm Nickel AB-Aged Brass	PHSD-Forward/Reverse Phase, 1% Dimming, 120V Only ⁶ 010S-0-10V, 1% Dimming, 120V/277V ⁶ 0103-0-10V, 1% Dimming, 347V Only ³ 010L-EldoLED, 0-10V, Linear, 0.1% Dimming, 120V/277V ³ 010G-EldoLED, 0-10V, Log, 0.1% Dimming, 120V/277V ³ DALI8-EldoLED, DALI Protocol 2, DT-6, 0.1% Dimming, 120V/277V ³ DALI8-EldoLED, DALI Protocol 2, DT-8, 0.1% Dimming, 120V/277V ³ LUTE-Lutron Hilume Ecodigital, 1% Dimming, 120V/277V ^{2,3} DMX-EldoLED, DMX, 0.1% Dimming, 120V/277V ³	NA-None EMG-Emergency Driver ^{3,4}

1 - Premium finishes may have extended lead times. Custom RALs are available, please consult Inside Sales with specific request.

2 - LUTE driver is not available at 700 lumens.

3 - Drivers 0103/010L/010G/DALI/DALI8/DMX/LUTE/EMG are only available with HRM - Remote Power Supply.

4 - Emergency option comes prewired from factory with driver in remote housing. 8W of continuous power provided for a minimum of 90 minutes. Must be installed within 30 feet of luminaire using 18 AWG wire. Not available with 0103, DMX, DALI8 or LUTE Driver.

5 - AWWNR/CSMB available upon request.

6 - SQR Canopy with 010S/PHSD is not available with 700 lumens.

CONTACT FACTORY FOR MORE OPTIONS.

LETO 44 MINI

MONO POINT CYLINDER

WARM DIM

Canopy

RDS
Round Slim Canopy

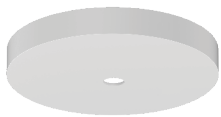
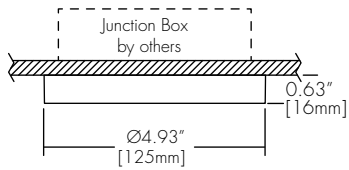

SQS
Square Slim Canopy

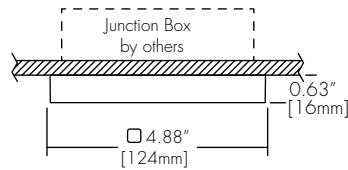

RTL
Round Flangless Canopy

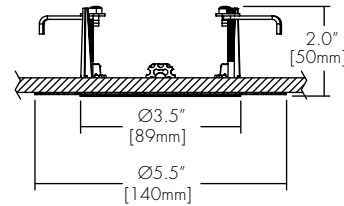

SQR
Semi-Recessed

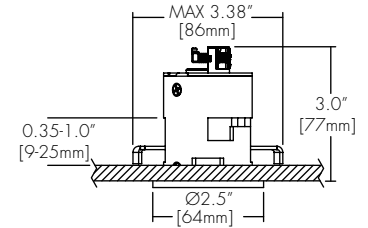

RDS or SQS	
Integral Drivers	PHSD, 010S
Remote Drivers	0103, 010L, 010G, DALI, DALI8, LUTE, DMX

RTL or SQR	
Integral Drivers	
Remote Drivers	PHSD, 010S, 0103, 010L, 010G, DALI, DALI8, LUTE, DMX

Lens & Accessory Options

DL
Diffusing Lens



HC
Honeycomb



Optics

FXX (20°, 30°, 60°)
Faceted Reflector



Remote Driver Housing

Depending on the options selected in the order code on page 1, a Remote Driver Housing may be required. This will automatically be generated and put on your order as necessary.

REMOTE DRIVER	MODEL	OUTPUT	CCT	DRIVER	DRIVER OPTIONS
HRM-Housing, Remote	LET44M-MP - Leto 11 Mini Mono Point	Same as Fixture	Same as Fixture	Same as Fixture	Same as Fixture

Maximum mounting distance to luminaire using 18 AWG wire								
PHSD	010S	0103	010L	010G	DALI	DALI8	LUTE	DMX
16'	16'	16'	72'	72'	72'	72'	15'	149'

4" J-box

Minimum volume required to mount drivers in junction box: 70mm x 40mm x 30mm.

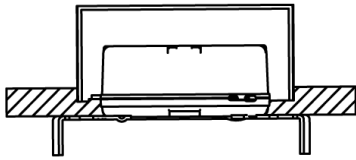

Canopy	+	Driver
RDS	+	PHSD
RDS	+	010S
SQS	+	PHSD
SQS	+	010S

HRM Single with Externally Mounted Driver

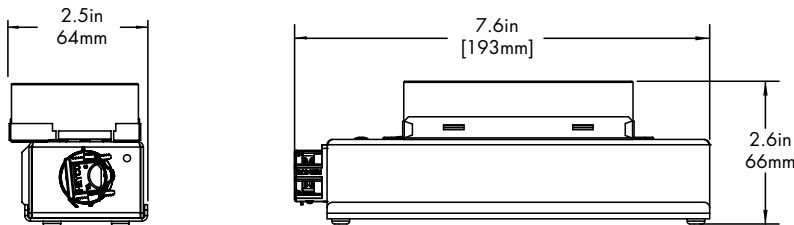

Driver
0103
010L
010G
010S
DALI
LUTE

HRM Double

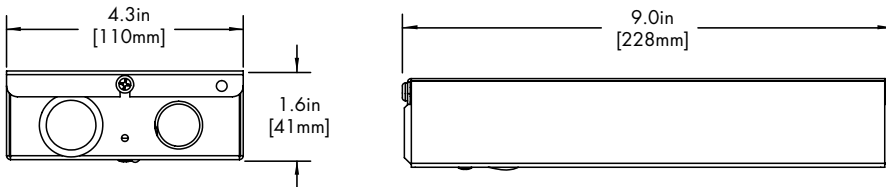

Driver
DALI8
DMX

HRM Cylinder Driver

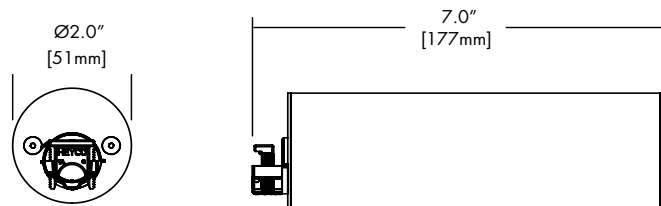

Canopy	+	Driver
SQR	+	010S
SQR	+	PHSD

EMG Emergency Driver

120 minute EMG operation time.

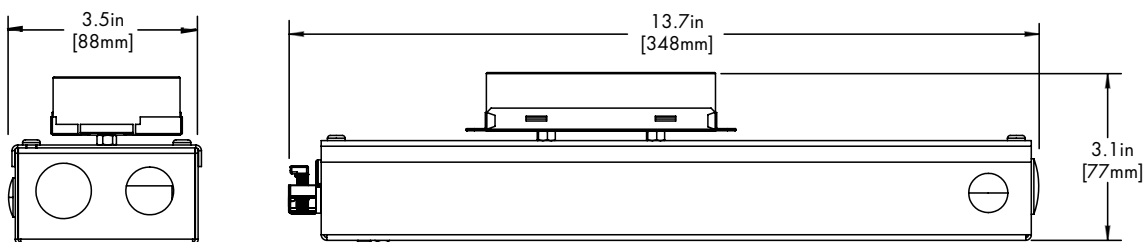

Driver
EMG

LETO 44 MINI

MONO POINT CYLINDER

WARM DIM

Standard Finishes

BK

Black



WH

White

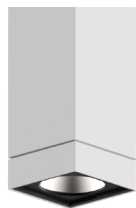

SL

Silver

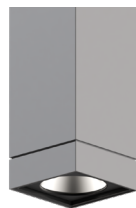

Premium Finishes

MA

Mocha



CC

Charcoal



CR

Cerulean

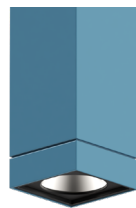

FB

Firebrick

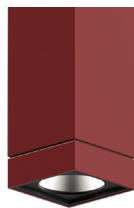

BZ

Bronze



WN

Warm Nickle



AB

Antique Bronze



TM-30

Warm Dim 1800K

COLOR VECTOR GRAPHIC

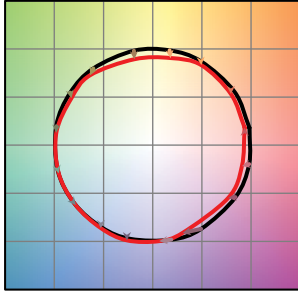

— Reference Source — Test Source

Warm Dim 3000K

COLOR VECTOR GRAPHIC

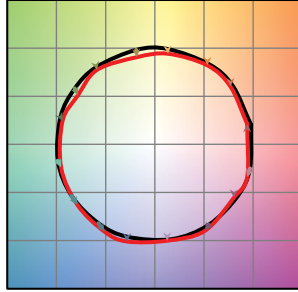

— Reference Source — Test Source

Photometry

20° Faceted Reflector

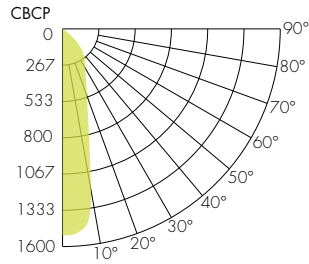
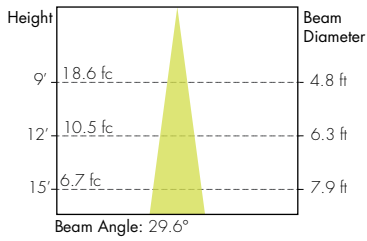

30° Faceted Reflector

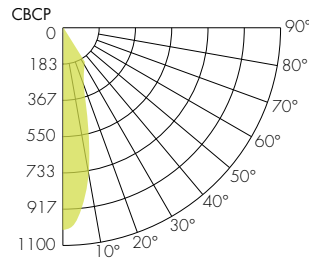
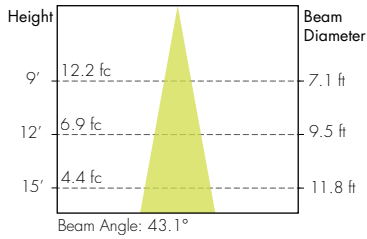

60° Faceted Reflector

