

# LETO 11

LOW BAY HIGH POWER LED



## Features

- Faceted reflector provides beam spreads between 18° to 60°.
- Nine driver selections available to cover wide range of applications.
- Four output options available up to 4500 lumens.
- 5 year warranty.



## Finish Options

- White
- Mocha
- Black
- Charcoal
- Silver
- Cerulean
- Firebrick

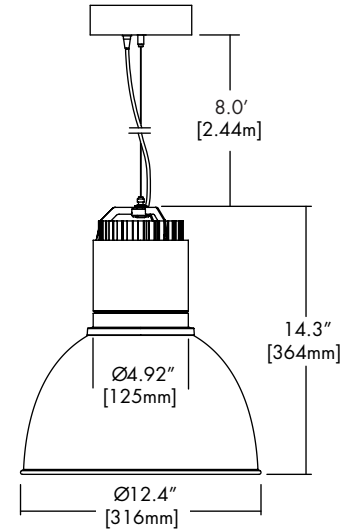

## Technical Information

OUTPUT OPTIONS	3000 lm	3500 lm	4000 lm	4500 lm
<b>Fixture wattage</b>	29.2 W	34.7 W	44.9 W	50.7 W
<b>Delivered Lumen</b>	3170 lm	3452 lm	3908 lm	4497 lm
<b>Efficacy</b>	94 lm/W	85lm/W	76 lm/W	77 lm/W
<b>Center Beam Candlepower (18° Faceted Reflector)</b>	16857 cd	18356 cd	20781 cd	23913 cd

CCT	Multiplier	CRI	TM-30		
			R <sub>f</sub>	R <sub>g</sub>	R <sub>9</sub>
2700K	0.92	93+	92	100	50+
3000K	0.97	93+	92	103	50+
3500K	1.00	93+	93	102	50+
4000K	1.07	93+	92	101	50+
6500K	1.05	93+	92	101	50+

## Ordering Code

Integral Driver Example: Fixture LET11-LBHP-30-27K-F18-CR-WH-WH-SQ-WH-1AF-CL-PHSD-NA

Remote Driver Example: Fixture LET11-LBHP-30-27K-F18-CR-WH-WH-SQ-WH-1AF-CL-PHSD-NA-HRM-LET11-LBHP-30-27K-PHSD-NA

### Fixture

MODEL	TYPE	OUTPUT	CCT	OPTIC	ACCESSORY	BODY FINISH	BAFFLE FINISH
LET11-Leto 11	LBHP-Low Bay High Power	30-3000 lumens(29.2W) 35-3500 lumens(34.7W) 40-4000 lumens(44.9W) 45-4500 lumens(50.7W) <sup>1</sup>	27K-2700K 30K-3000K 35K-3500K 40K-4000K 65K-6500K	F18-18 Degree, Faceted F30-30 Degree, Faceted F45-45 Degree, Faceted F60-60 Degree, Faceted	CR-Clear Reflector FR-Frosted Reflector	Standard WH-White BK-Black SL-Silver  Premium MA-Mocha CC-Charcoal CR-Cerulean FB-Firebrick	Standard WH-White BK-Black SL-Silver  Premium MA-Mocha CC-Charcoal CR-Cerulean FB-Firebrick

CANOPY/ HOUSING	CANOPY FINISH	SUSPENSION TYPE	SUSPENSION FINISH	DRIVER	DRIVER OPTIONS
SQ-Square	Standard WH-White BK-Black SL-Silver  Premium MA-Mocha CC-Charcoal CR-Cerulean FB-Firebrick	1AF-1AC+Feed Cable	Standard CL-Clear WH-White BK-Black	PHSD-Forward/Reverse Phase, 1% Dimming, 120V Only 010S-0-10V, 1% Dimming, 120/277V 0103-0-10V, 1% Dimming, 347V Only <sup>2</sup> 010L-EldoLED, 0-10V, Linear, 0.1% Dimming, 120/277V 010G-EldoLED, 0-10V, Log, 0.1% Dimming, 120/277V DALI-EldoLED, DALI Protocol 2, DT-6, 0.1% Dimming, 120/277V DALI8-EldoLED, DALI Protocol 2, DT-8, 0.1% Dimming, 120/277V <sup>3</sup> LUTE-Lutron Hilume Ecodigital, 1% Dimming, 120V/277V <sup>2</sup> DMX-EldoLED, DMX, 0.1% Dimming, 120V/277V <sup>3</sup>	NA-None EMG-Emergency Driver <sup>3,4</sup> CSMB-Casambi <sup>5,6</sup> AWN- Athena <sup>5,6</sup>

1 - 4500 lumens is only available with remote mount power supply 010S

2 - 0103/LUTE drivers are only available with 3000/3500 lumens.

3 - All drivers remote mounted when using DALI8 driver, DMX driver, or EMG driver options.

4 - Emergency option comes prewired from factory with driver in remote housing. 8W of continuous power provided for a minimum of 90 minutes.

Must be installed within 30 feet of luminaire using 18 AWG wire. Not available with 0103, DMX, DALI8 or LUTE Driver.

5 - AWNR/CSMB only available with 010S driver.

6 - AWNR/CSMB are only available with 3000/4000 lumens.

CONTACT FACTORY FOR MORE OPTIONS.

## Canopy

### SQ

Square Canopy

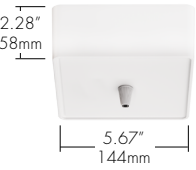
	Integral Drivers	Remote Drivers
	010S	DAI18
	0103	DMX
	PHSD	
	010L	
	010G	
	DALI	
	LUTE	

Please see next page for Remote Driver Housing details.

## Suspension

### 1AF

1 Aircraft + Feed Cable



## Accessories

### CR

Clear Reflector



### FR

Frosted Reflector



## Remote Driver Housing

Depending on the options selected in the order code on page 1, a Remote Driver Housing may be required. This will automatically be generated and put on your order as necessary.

REMOTE DRIVER	MODEL	OUTPUT	CCT	DRIVER	DRIVER OPTIONS
HRM-Housing, Remote	LET11-LBHP-Leto 11 Low Bay High Power	Same as Fixture	Same as Fixture	Same as Fixture	Same as Fixture

Maximum mounting distance to luminaire using 18 AWG wire								
PHSD	010S	0103	010L	010G	DALI	DALI8	LUTE	DMX
16'	16'	16'	72'	72'	72'	72'	15'	149'

## HRM Single with Externally Mounted Driver

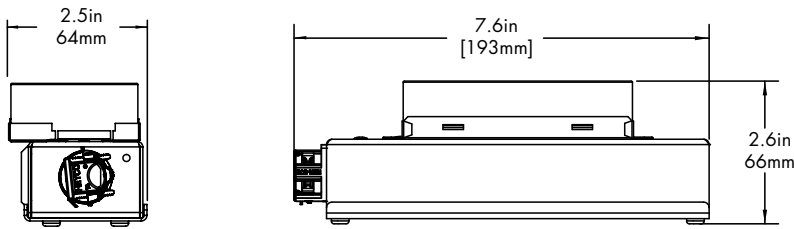

Driver
0103

## HRM Double

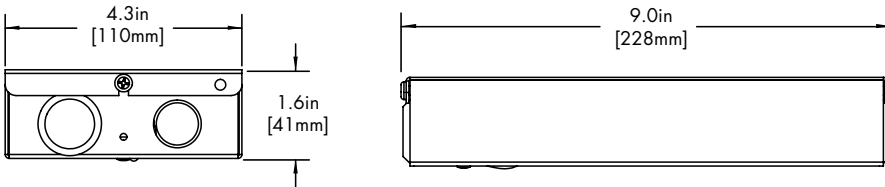

Driver
DALI8
DMX

## EMG Emergency Driver

120 minute EMG operation time.

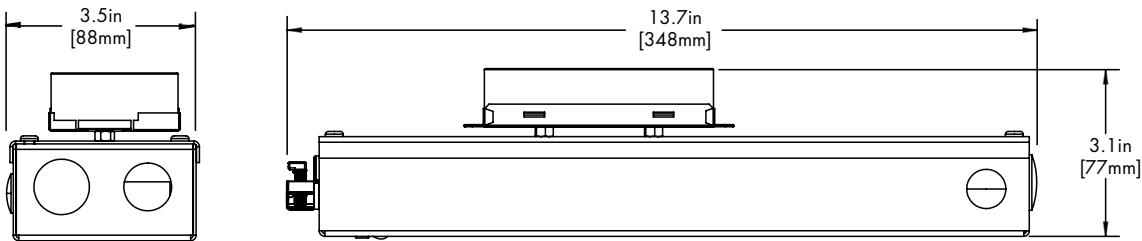

Driver
EMG

## Standard Finishes

**BK**  
Black



**WH**  
White



**SL**  
Silver



## Premium Finishes

**MA**  
Mocha



**CC**  
Charcoal



**CR**  
Cerulean



**FB**  
Firebrick



## Two Tone Baffle

Inside finish refers to Baffle Finish selection from page 1. Any combination may be used for baffle and body finishes.

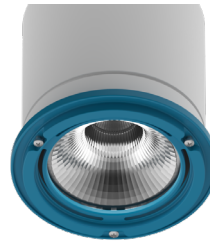

## TM-30

**2500K**

COLOR VECTOR GRAPHIC

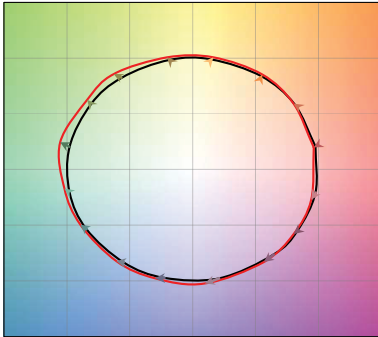

— Reference Source — Test Source

**2700K**

COLOR VECTOR GRAPHIC

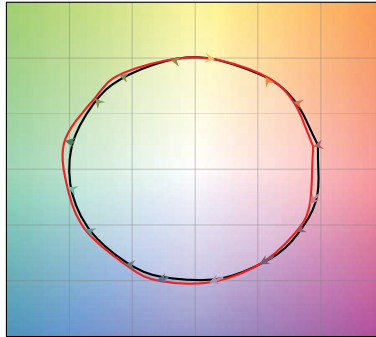

— Reference Source — Test Source

**3000K**

COLOR VECTOR GRAPHIC

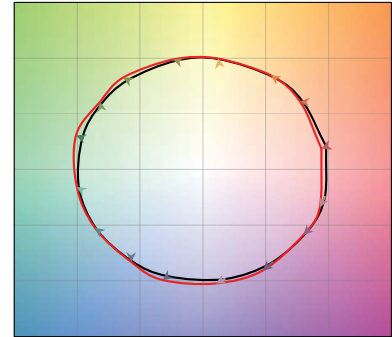

— Reference Source — Test Source

**3500K**

COLOR VECTOR GRAPHIC

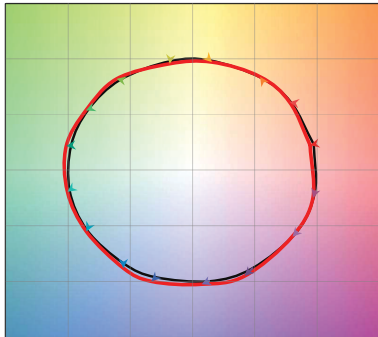

— Reference Source — Test Source

**4000K**

COLOR VECTOR GRAPHIC

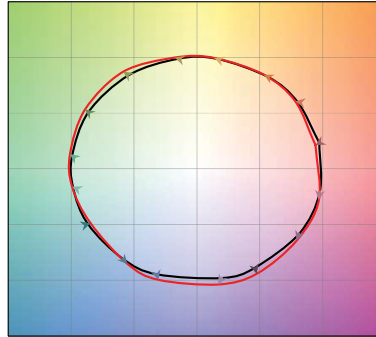

— Reference Source — Test Source

**6500K**

COLOR VECTOR GRAPHIC

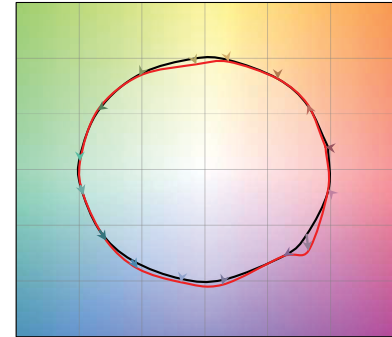

— Reference Source — Test Source

## Photometry

### 18° Faceted Reflector

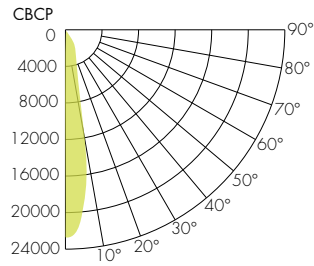
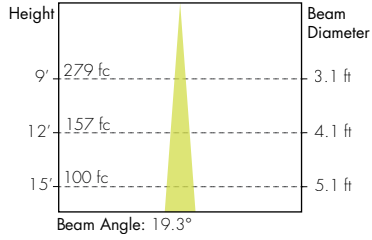

### 30° Faceted Reflector

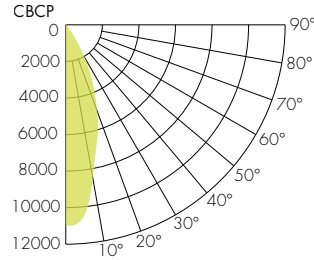
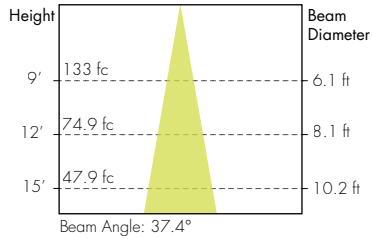

### 45° Faceted Reflector

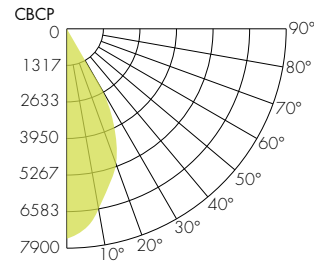
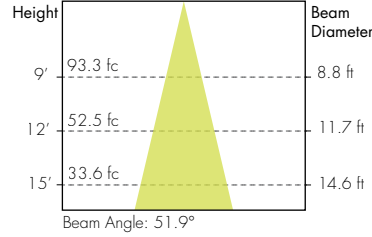

### 60° Faceted Reflector

