

Features

LLX18X2-RGBW is a high performance flexible LED fixture suitable for use in coves, under cabinets, in shelves, and virtually anywhere a linear fixture is required.
 Standard Colors/Color Temperatures: RGBW and RGBA.
 LLX18X2-RGBW is dimmable via DMX.



Mounting

LLED strip is equipped with 3M™ adhesive transfer tape (9472LE).

Applications

Indoor only - millwork, cove, architectural reveals, undercabinet, display case, handrail, accent lighting.

Approvals

Class 2 damp listed

Operating voltage

24 VDC

Average Life (L70)

50,000 hours

Warranty

7 years



Technical information

TYPE	LLX18X2-RGBW
OUTPUT OPTIONS	RGB+3000K
Lumens Output (all channels full on)	438 lm/ft
Average Power Consumption (for a 4' section)	8.8 W/ft
Efficacy	59 lm/W
Cutting Increment	3.94"
Pitch Length	0.66"
Max Run Length (in series)	10 ft
Dimensions	0.79" W x 0.10" H

RGBW (3000K)					
Tape	TM-30				
	CRI	R _f	R _g	R ₉	
LLX18X2-RGBW	93	91	99	64	

Dominant Wavelength	
Color	RGB/RGBW
Red	621nm
Green	519nm
Blue	465nm

Section Start/End Options

SL

Soldered lead wires (72")

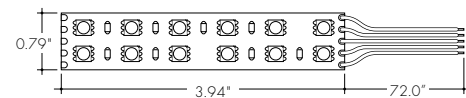

LF

Lead Female 3" cable

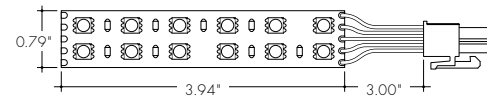

LM

Lead Male 3" cable

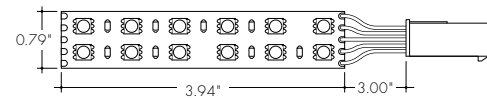

NC

No connector

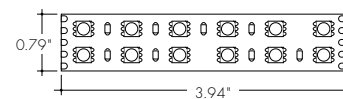

Ordering Code

MODEL	COLOR	SECTION START	SECTION END	LENGTH
LLX18X2-RGBW	30K - RGB with 3000K	F - Female connector M - Male connector SL - Soldered lead wires (72") NC - No connector	F - Female connector M - Male connector SL - Soldered lead wires (72") NC - No connector	View specs above for increment options and maximum run limits.

Accessories

LC-I5P-M

Indoor Lead Connector (Male)

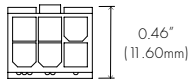
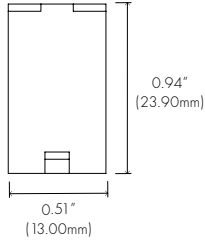
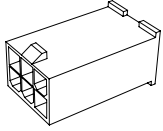

LC-I5P-F

Indoor Lead Connector (Female)

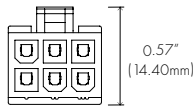
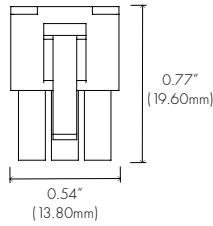
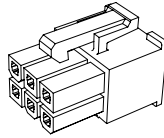

LL.ZIP

Strain Relief Clip

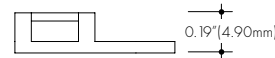
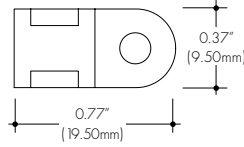
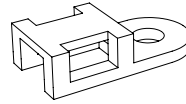

LO-18G-5C-W-72

6' (1.8M) wire lead (not in-wall rated)

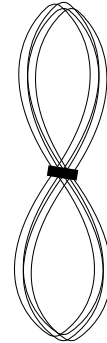

Accessories

CL2

Mounting Clip

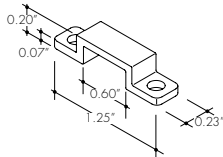

recommended at every 12" when LineLED strip is facing down.

LVSP-4T-BK

Splice Box

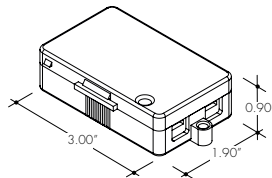

low voltage, 4 terminal splice box, black.

LL.ZIP

Cable/Wire Strain Relief Clip

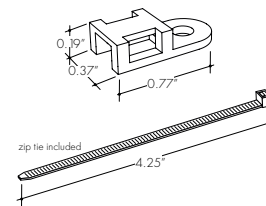

Lens Options / Light Transmission



Clear



Half (50%)
Frosted



Graze



Frosted



Flat
Frosted



Raised



Square
Frosted



Round Square
Frosted



13°
Semi-Frosted

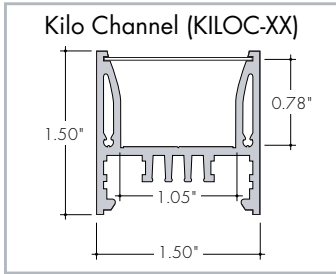

C **F**
85% 75%

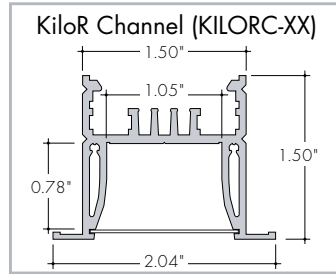

C **F**
85% 75%

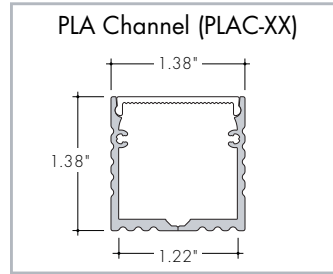

C **F**
XX% XX%

Led Dotting per Extrusion

using the frosted lens option

Installation

All mounting channels are field cuttable using miter saw with circular blade suitable for cutting aluminum.

Ordering

Extrusions are sold separately. View respective specsheets for details on ordering extrusions and their accessories (endcaps, mounting brackets, etc).

Extrusion	LED Models
	LLTW60X2 (All on)
KILOC	ND
KILORC	ND
PLAC	ND

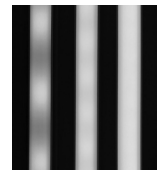

CD **SD** **ND**
CD - Clear Dotting
SD - Slight Dotting
ND - No Dotting

Power Supplies

See fixture and power supply instructions & spec sheet for wiring information. Dimming possible in select models - view luminii website for list of compatible dimmers.

Ordering Code DMX Dimming Power Supplies 0.1% 120VAC - 277VAC Requires Controller

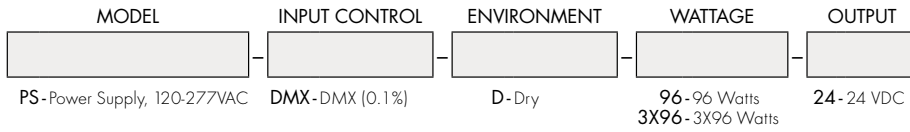

MODELS	96W	3X96
Length	14.40"	15.00"
Width	5.20"	6.62"
Depth	2.60"	4.56"

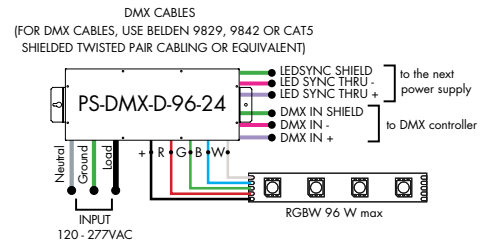
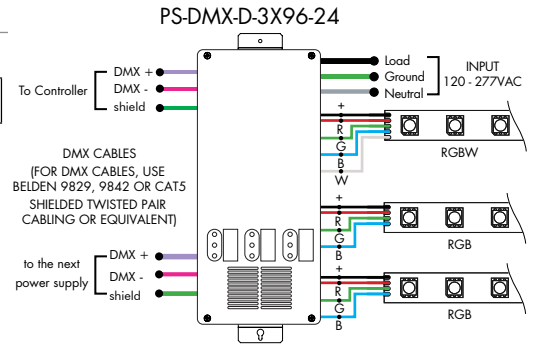

Ordering Code Non-Dimming Power Supply 120VAC - 277VAC Requires Controller and Decoder

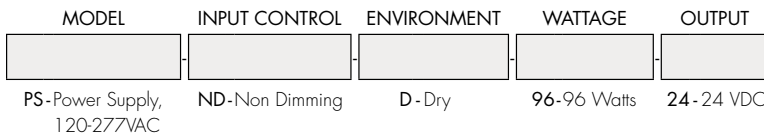

MODELS	96W
Length	14.40"
Width	5.20"
Depth	2.60"

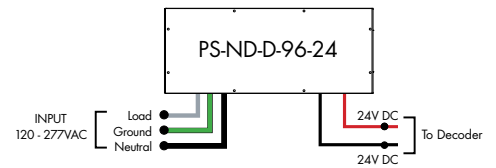

Ordering Code Universal Dimming Power Supplies 1% 120VAC - 277VAC Requires Controller and Decoder

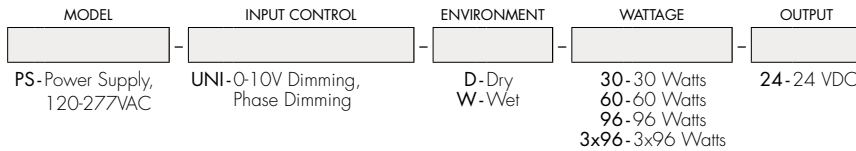

Compatibility: View a complete list of compatible dimmers on product page [\(Link\)](#) 0-10V - 1% dimming
MLV/ELV/TRIAC - 1% dimming, consult dimming compatibility chart

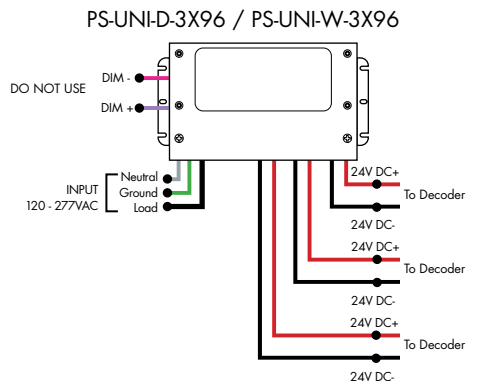
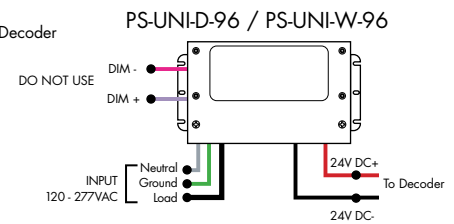

MODELS	PS-UNI-W-30W	PS-UNI-W-60W	PS-UNI-W-96W	PS-UNI-W-3X96W
Length	6.50"	7.40"	8.66"	11.85"
Width	3.73"	3.73"	3.73"	4.32"
Depth	1.61"	1.61"	1.61"	1.81"

MODELS	PS-UNI-D-30W	PS-UNI-D-60W	PS-UNI-D-96W	PS-UNI-D-3X96W
Length	8.77"	8.77"	8.11"	9.94"
Width	4.27"	4.27"	5.60"	7.61"
Depth	1.83"	1.83"	1.83"	2.02"

Controllers and Decoders



MODEL

RGBW-RC-R

RGBW-RC-R - RGBW receiver

The RGBW receiver is easily paired with controller by the click of a button. Receiver can be reset to factory settings at any time.

Each receiver can store one static RGB color, one color sequence, and one brightness setting for the white LED strip. Receivers assigned to the same scene within the same zone will have the same LED static color and color sequence.

Operating Voltage
12-36 VDC

Power Capacity
up to 96W at 24V

Operating Temperature Range
from -4°F to +122°F in case



MODEL

RGBW-SR

RGBW-SR - RGBW signal repeater

Extends identical signal when connected in series to an RGBW LED control system. The RGBW signal repeater works with Luminii RGB and RGBW controllers, receivers, and decoders.

RGBW signal can be extended indefinitely when adequate power supply (not included) is connected to the system.

Operating Voltage
12-36 VDC

Power Capacity
up to 96W at 24V

Operating Temperature Range
from -4°F to +122°F in case



MODEL

DDMX-RGBW

DDMX-RGBW - DMX decoder

Translates controller DMX512 programs for RGB and white LED strips.

Unique DMX address for the decoder can be set easily and displayed by the numeric display on the case. Changing and resetting the DMX address requires manual input.

Use power repeater to expand output.

Operating Voltage
12-36 VDC

Power Capacity
up to 96W at 24V

Operating Temperature Range
from -4°F to +122°F in case

Controllers and Decoders



MODEL

RGBW-MC3

RGBW-MC3 - 4-zone RGBW controller

Easy to operate wireless interface suitable for static or color changing scenes. Control 4 different color zones separately or at the same time. RGBW receiver (RGBW-RC-R) required for operation. Assign multiple receivers per zone to cover a large area.

Color wheel enables highly stable and sensitive color control functionality. Create your own color changing sequences with ease and flexibility.

Power

qty 3 AAA batteries

Scenes

up to 4 unique zones

Signal

Wireless (RF)

Energy Saving

Deactivates after 10 seconds of inactivity

Color Parameters

- Brightness
- Saturation
- Primary colors
- Speed of color changing sequence
- Fading

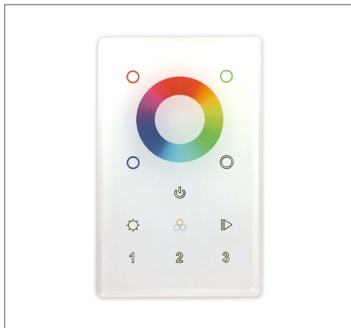

MODEL

ZONES

COLOR

DMX - DMX Controller	3Z - Three Zone 1Z - One Zone	RGBW - Red, Green, Blue, & White
----------------------	----------------------------------	----------------------------------

DMX /Wireless RGB-W wall-mount controller controls DMX lighting fixtures, wireless control of RGB-W lighting fixture or use both simultaneously. Fits in any standard US switch box. Includes all the outputs in the back of the controller.

Control brightness levels with a single touch, personalize and memorize 3 different scenes, and even create 3 variations of white.

Features

- 2 in 1 in-Wall Controller: DMX Control or Wireless RGB-W
- 65,000 Color Options, Dimming and Speed Control
- Memory Function
- 50 Foot Wireless Range
- Easily Fits Standard US Switch Boxes
- Touch Sensitive Glass Surface
- Includes 10 Built in Programs, or Create and Play Your Own

Operating Voltage

12 - 24V DC

Color Parameters

- Brightness
- Saturation
- Primary colors
- Fading
- Color changing speed

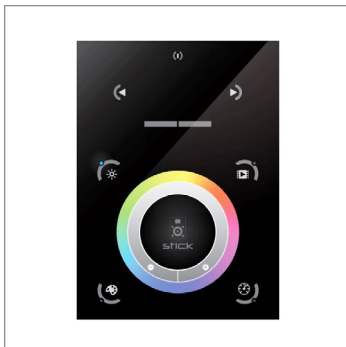

MODEL

TSDMX-E

TSDMX-E - Touchscreen DMX controller

Programmable advanced DMX512 lighting controller featuring a touch-screen interface. Operates as stand alone controller or integrated with most architectural lighting control systems. Can controller endless DMX512 enabled devices.

Mounts to standard single or dual gang wall box with the included power supply inside the junction box. Terminal block design for power and data connections.

Features

- Sleek glass design which sits 0.43" from the wall
- Graphical color display to show selected environment
- Color/dimmer/speed palette
- Color temperature mixing
- Touch sensitive buttons. No mechanical parts
- Touch sensitive wheel allows for accurate color selection
- Multi-zone microSD memory
- Multi-room control with 500 scenes, 10 zones
- 1024 DMX channels. Control 340 RGB fixtures
- USB & Ethernet connectivity for programming and control

Power Supply

7 VDC (included)

Programmability

PC, Mac, Tablet, Smartphone

Output Signal

DMX512 (1024 channels)

Color Parameters

- Brightness
- Saturation
- Speed of color changing sequence
- Fading / dimming / brightness

Controllers and Decoders



MODEL

DDMX-5CH-RDM-PRO

DDMX-5CH-RDM-PRO-DMX512 Decoder

DMX512 decoder with RDM functionality features 5 PWM output channels with common anode. High PWM output frequency range allows the product to be used in HD video conferencing spaces. All DMX products to be installed per DMX512 Standard.

Power
96 Watt

Inputs
RJ45, XLR-5Pin, Terminal Block

DMX Channels
1 to 5 settable

PWM Output Resolution Ratio
8 or 16 bit

PWM Output Frequency
500Hz - 30KHz

Output Dimming Curve Gamma Value
0.1 ~ 9.9



MODEL

RGBW-WI-R

RGBW-WI-R - WIFI generator

RGBW-WI-R creates a local network that enables any electronic device (phone, tablet, etc.) to control the RGB/W strip connected to a RGBW-RC-R receiver.

The control functions are achieved through a free application download for Android and iOS devices called REALCOLOR.

Operating Voltage
12-36 VDC

Power Supply
PI-130-24 (included)

Operating Temperature Range
from -4°F to +122°F in case