

Features

LineLED Tunable White Series Wet is a small profile high performance LED strip for IP65, IP67, and IP68 wet rated installations. This Tunable White LED series offers a wide CCT range to create the perfect ambiance in real time. From bright white encouraging wakefulness, to warm amber sunseting into relaxation, LineLED TW68 can transform any environment to match the natural human circadian rhythm. Industry-best color consistency with single-binned LEDs, 120 LEDs per foot. This High Color Quality LED strip boasts CRIs and R9 values up to 97. It is easily installed within discrete aluminum extrusions with multiple mounting options.



Mounting

LED strip is equipped with 3M™ self-adhesive tape.

Applications

Outdoor and wet locations - cove lighting, architectural accent, handrail, wet bars.

Operating voltage

24 VDC

Average Life (L70)

50,000 hours

Warranty

3 years



Approvals

IP65, IP67 and IP68 Rated



Technical information

TYPE	LLTW68WET-T			
	SO (19K-35K)	SO (27K-65K)	HO (19K-35K)	HO (27K-65K)
OUTPUT OPTIONS				
Lumens Output (all channels full on)	299 lm/ft [29K]	380 lm/ft [44K]	352 lm/ft [29K]	456 lm/ft [44K]
Average Power Consumption (for a 4' section)	4.6 W/ft		5.6 W/ft	
Efficacy	65 lm/W	75 lm/W	63 lm/W	74 lm/W
Ordering Increment (in)	2.46"			
Max Run Length (in series)	32 ft			
Dimensions	0.53"W x 0.24" H			

CCT	CRI	TM-30		
		R _f	R _g	R ₉
1900K	97	94	98	95
2700K	98	96	101	91
2900K	98	96	102	94
3500K	97	94	105	97
4400K	97	91	101	97
6500K	92	88	97	64

Section Start/End Options

SL65

72" Soldered Leads, IP65 rated

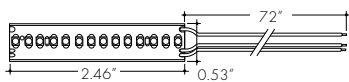

SL68

72" Soldered Leads, IP68 rated

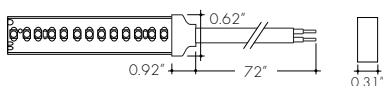

LF

Female Quick Connect End, IP67 rated

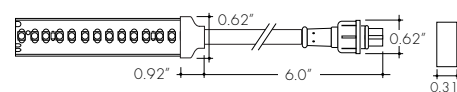

LM

Male Quick Connect End, IP67 rated

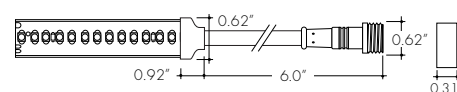

NC

No Connector

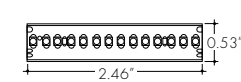

IP65 rated when used with SL65 selection

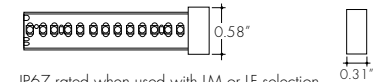

IP67 rated when used with LM or LF selection
IP68 rated when used with SL68 selection

Ordering Code

MODEL	OUTPUT	CCT	SELECTION START ¹	SELECTION END ¹	LENGTH
LLTW68WET-T-LineLED TW68 Wet Tube	SO-Standard HO-High	19K-35K- 1900K - 3500K 27K-65K- 2700K - 6500K	SL65-IP65 Soldered lead wires (72") SL68-IP68 Soldered lead wires (72") LF-IP67 Female Quick Connect LM-IP67 Male Quick Connect NC-No Connector	SL65-IP65 Soldered lead wires (72") SL68-IP68 Soldered lead wires (72") LF-IP67 Female Quick Connect LM-IP67 Male Quick Connect NC-No Connector	Ordered in one foot increments. See chart above for max run length.

1- IP rating of strip is equal to the lowest IP rating of section start and end options.

Accessories

LVSP-WET

Splice box: wet rated, low voltage, gray

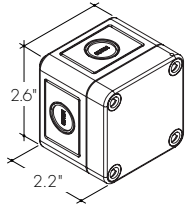

LVSP-WET-CM

Splice box connector, low voltage, gray

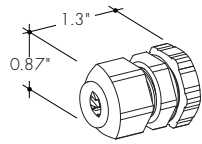

CL2

Mounting clip

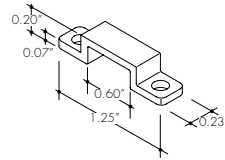

Recommended every 12" when LineLED strip is facing down

LL.ZIP

Cable/Wire Strain Relief Clip

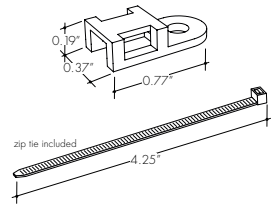

Lens Options / Light Transmission



Clear



Half (50%)
Frosted



Graze



Frosted



Flat
Frosted



Raised



Square
Frosted



Round Square
Frosted



13°
Semi-Frosted

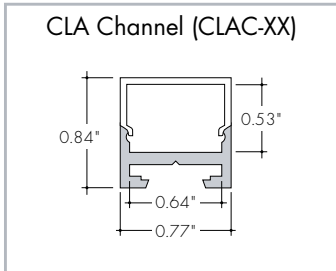

S **Q**
62% 65%

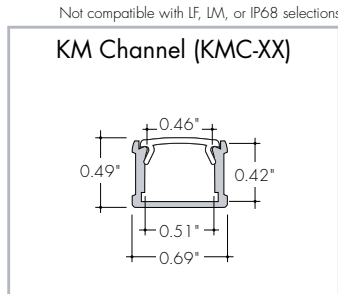

C **HF** **F** **FF** **R**
82% 68% 45% 52% 58%

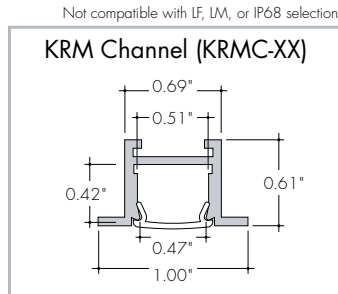

C **HF** **F** **FF**
82% 68% 45% 52%

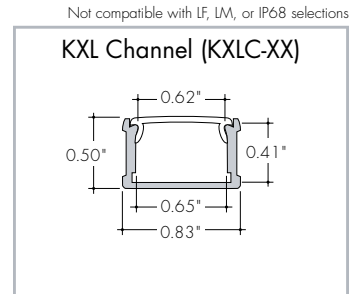

C **HF** **F**
79% 66% 49%

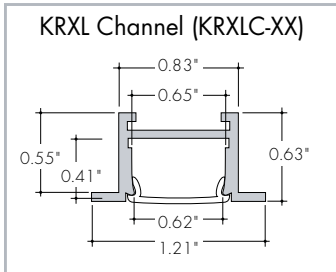

C **HF** **F**
79% 66% 49%

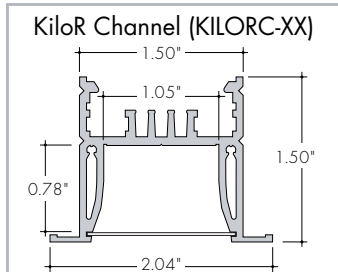

C **F**
85% 75%

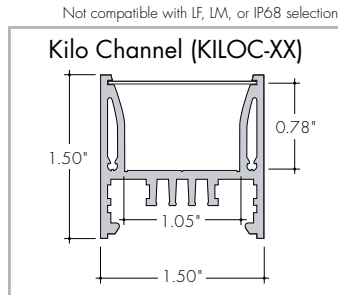

C **F**
85% 75%

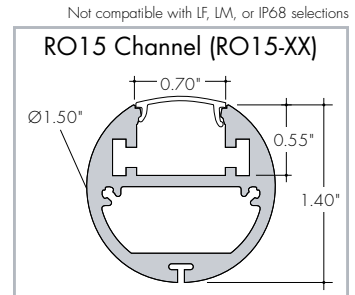

C **F**
65% 41%

Installation

All mounting channels are field cuttable using miter saw with circular blade suitable for cutting aluminum.

Ordering

Extrusions are sold separately. View respective specsheets for details on ordering extrusions and their accessories (endcaps, mounting brackets, etc).

Led Dotting per Extrusion

using the frosted lens option

Extrusion	LED Models	
	LLTW68 (All On)	LLTW68 (1-Channel)
CLA	ND	ND
KL	ND	ND
KRL	ND	ND
KXL	ND	ND
KRXL	ND	ND
RO15	ND	ND

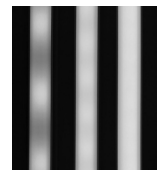

CD **SD** **ND**
CD - Clear Dotting
SD - Slight Dotting
ND - No Dotting

Power Consumption

Tested at full power with PDC Series power supplies.

Nominal Length	LLTW68WET-T-SO		LLTW68WET-T-HO	
	W/ft	Total Wattage	W/ft	Total Wattage
1	4.6	4.6	5.9	5.9
2	4.7	9.8	5.9	12.3
3	4.7	14.5	5.9	18.3
4	4.7	19.0	5.9	24.0
5	4.6	22.5	5.8	28.6
6	4.7	27.6	5.6	33.1
7	4.4	30.5	5.5	38.5
8	4.5	35.8	5.5	44.2
9	4.4	39.7	5.3	47.8
10	4.2	42.7	5.2	52.5
11	4.2	46.5	5.0	55.7
12	4.0	48.5	4.9	59.6
13	4.0	51.1	4.8	61.3
14	4.0	55.4	4.6	64.0
15	4.0	59.4	4.5	67.8
16	3.8	61.4	4.4	70.4
17	3.7	63.5	4.3	72.6
18	3.6	65.6	4.1	73.5
19	3.5	67.6	3.9	73.7
20	3.5	69.6	3.7	74.7
21	3.4	71.2	3.6	75.5
22	3.3	72.4	3.5	76.5
23	3.2	73.7	3.4	77.5
24	3.1	74.8	3.3	78.5
25	3.1	77.2	3.2	79.9
26	3.0	78.0	3.1	80.7
27	2.9	78.9	3.0	81.6
28	2.8	79.8	3.0	82.8
29	2.8	81.0	2.9	82.9
30	2.7	81.3	2.8	83.5
31	2.7	82.2	2.7	84.2
32	2.6	82.6	2.7	84.8

Voltage Drop Calculator

The below chart assumes nominal voltage of 24 Volts and a Voltage Drop Allowance of 3% through the wire

Wattage [W]	Maximum Wire Length From Power Supply to Start of Run [ft]						
	12 AWG	14 AWG	16 AWG	18 AWG	20 AWG	22 AWG	24 AWG
5	1088.2	684.4	430.3	270.6	170.2	107.1	67.3
10	544.1	342.2	215.1	135.3	85.1	53.5	33.7
15	362.7	228.1	143.4	90.2	56.7	35.7	22.4
20	272.0	171.1	107.6	67.7	42.6	26.8	16.8
25	217.6	136.9	86.1	54.1	34.0	21.4	13.5
30	181.4	114.1	71.7	45.1	28.4	17.8	11.2
35	155.5	97.8	61.5	38.7	24.3	15.3	9.6
40	136.0	85.5	53.8	33.8	21.3	13.4	8.4
45	120.9	76.0	47.8	30.1	18.9	11.9	7.5
50	108.8	68.4	43.0	27.1	17.0	10.7	6.7
55	98.9	62.2	39.1	24.6	15.5	9.7	6.1
60	90.7	57.0	35.9	22.6	14.2	8.9	5.6
65	83.7	52.6	33.1	20.8	13.1	8.2	5.2
70	77.7	48.9	30.7	19.3	12.2	7.6	4.8
75	72.5	45.6	28.7	18.0	11.3	7.1	4.5
80	68.0	42.8	26.9	16.9	10.6	6.7	4.2
85	64.0	40.3	25.3	15.9	10.0	6.3	4.0
90	60.5	38.0	23.9	15.0	9.5	5.9	3.7
96	56.7	35.6	22.4	14.1	8.9	5.6	3.5

Power Supplies

See fixture and power supply instructions & spec sheet for wiring information. Dimming possible in select models - view Luminii website for list of compatible dimmers.

Ordering Code DALI2 Dimming Power Supplies 0.1% 120VAC - 277VAC

MODEL	INPUT CONTROL	ENVIRONMENT	WATTAGE	OUTPUT	OUTPUT CONTROL
PS - Power Supply, 120-277VAC	DALI-DT8 - DALI DT8 Tunable White (0.1%)	D - Dry	96-96 Watts	24-24 VDC	PWM - Pulse Width Modulation

MODELS	96W
Length	14.40"
Width	5.20"
Depth	2.60"

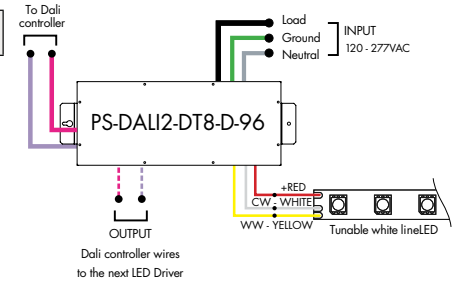

Athena DALI2-DT8 LED Driver

MODEL	INPUT CONTROL	ENVIRONMENT	WATTAGE	OUTPUT	FEATURE
PS - Power Supply, 120-277VAC	DALI-DT8 - DALI DT8 Tunable White	D - Dry	96-96 W	24-24 VDC	AWNDR - Athena

MODELS	96W
Length	14.40"
Width	5.20"
Depth	2.60"

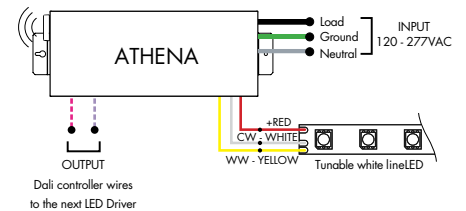

Ordering Code VintageDim® 0 - 10V Dimming Power Supplies 120VAC - 277VAC

MODEL	INPUT CONTROL	ENVIRONMENT	WATTAGE	OUTPUT
PS - Power Supply, 120-277VAC	010V-WD - 0-10V Dimming, Standard Warm Dim Curve (with Tunable White LED) 010V-TW - 0-10V Dimming, Two Channel Control, Brightness and CCT1-CCT2 Ratio 010V-2CH - 0-10V Dimming, Two Channel Control, LED1 Brightness and LED2 Brightness 010V-WDX - 0-10V Dimming, Customizable Warm Dim Curve (with Tunable White LED) 010V-2CHX - 0-10V Dimming, Two Channel Control, Customizable Brightness and CCT1-CCT2 Ratio	D - Dry	96-96 Watts 3X96 - 3x96 Watts ¹	24-24 VDC

¹ - 3x96 is only available with input control options 010V-WD and 010V-TW
² - Athena only available on 96 watts option

MODELS	96W	3X96
Length	14.40"	15.00"
Width	5.20"	6.62"
Depth	2.60"	4.56"

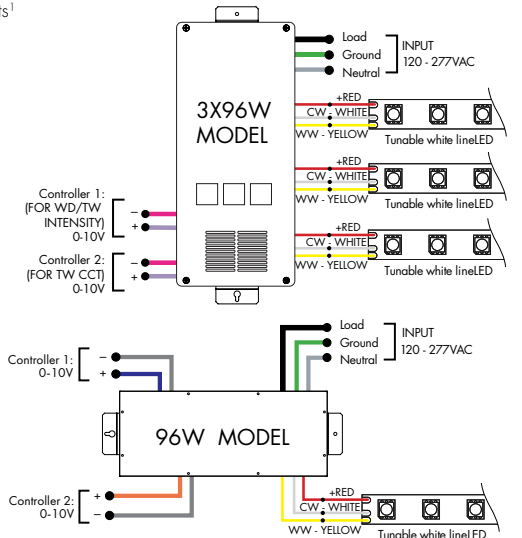

Power Supplies

See fixture and power supply instructions & spec sheet for wiring information. Dimming possible in select models - view Luminii website for list of compatible dimmers.

Athena 0-10V Warm Dim LED Driver

MODEL	INPUT CONTROL	ENVIRONMENT	WATTAGE	OUTPUT	FEATURE
PS-Power Supply, 120-277VAC	010V-WD-0-10V Dimming, Standard Warm Dim Curve (with Dynamic White LED)	D-Dry	96-96 W	24-24 VDC	AWNDR-Athena

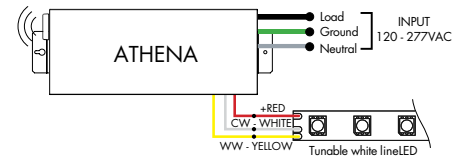

MODELS	96W
Length	14.40"
Width	5.20"
Depth	2.60"

Athena 0-10V Two Channel LED Driver

MODEL	INPUT CONTROL	ENVIRONMENT	WATTAGE	OUTPUT	FEATURE
PS-Power Supply, 120-277VAC	010V-2CH-0-10V Dimming Two Channel Control, LED1 Brightness and LED2 Brightness	D-Dry	96-96 W	24-24 VDC	AWNDR-Athena

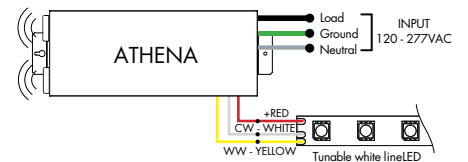

MODELS	96W
Length	14.40"
Width	5.20"
Depth	2.60"

Ordering Code DMX Dimming Power Supplies 0.1% 120VAC - 277VAC Requires Controller

MODEL	INPUT CONTROL	ENVIRONMENT	WATTAGE	OUTPUT
PS-Power Supply, 120-277VAC	DMX-DMX (0.1%)	D-Dry	96-96 Watts 3X96-3X96 Watts	24-24 VDC

MODELS	96W	3X96
Length	14.40"	15.00"
Width	5.20"	6.62"
Depth	2.60"	4.56"

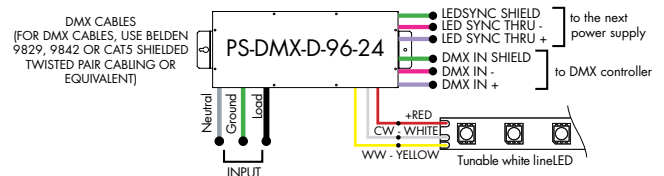
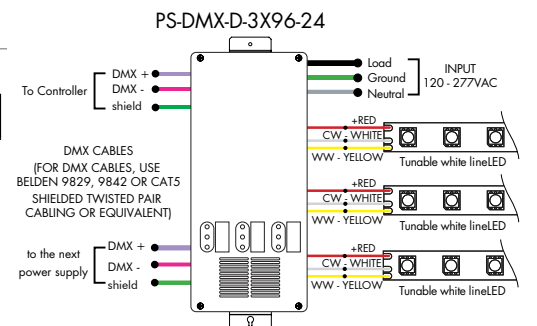

Controllers and Decoders



MODEL

DTW-MC

DTW-MC - Tunable White controller

Tunable White wall-mount controller controls lighting fixtures, wireless control of TW lighting fixture. Fits in any standard US switch box. Includes all the outputs in the back of the controller.

Features

- Switch & dimming control function, control range > 20M.
- Smooth transition between light levels.
- Separately operate dimming and color temperature functions.
- Able to control 1 zone with endless receivers. Each receiver can maximally be controlled by 8 remotes.
- Power, temperature color and dimming functions operated by push button after receivers are connected.

Operating Voltage

3V DC battery

Color Parameters

- Brightness
- Saturation
- Fading



MODEL

TW-DMX

TW-DMX - DMX controller

Tunable White DMX wall-mount controller is a fully touch sensitive controller designed in accordance with standard protocol DMX512. Offers fast and accurate color temperature adjustment and brightness dimming of natural white, warm white and cold white. Designed with a touch color wheel, the DMX512 controller can adjust color temperature and brightness for all white LEDs smoothly and accurately. The DMX controller can control 1 zone with endless decoders.

Features

- 1 zone
- 6 color scenes
- DMX Control
- Touch Sensitive Glass Surface
- Dimming and Speed Control
- Memory Function
- Easily Fits Standard US Switch Boxes

Operating Voltage

12 - 24V DC

Color Parameters

- Brightness
- Saturation
- Primary colors
- Fading
- Color changing speed



MODEL

SLD-DIMTW

SLD-DIMTW - Tunable white LED dimming module

The SLD DimTW is a constant voltage warm dimming LED dimming module. The unique dimming module accepts 0-10V control and mimics a smooth, incandescent dimming curve.

Features

- Flicker free 0-100% dimming
- High efficiency up to 97%
- High precision dimming ratio:>1:1000
- Fully isolated plastic housing
- Comply with EN55015 and FCC part 15 without additional input filter and capacitors
- compact size, high reliability
- 3 years warranty

Operating Voltage

8-48 VDC

Controllers and Decoders



MODEL

RGBW-RC-R

RGBW-RC-R - RGBW receiver

The RGBW receiver is easily paired with controller by the click of a button. Receiver can be reset to factory settings at any time.

Each receiver can store one static RGB color, one color sequence, and one brightness setting for the white LED strip. Receivers assigned to the same scene within the same zone will have the same LED static color and color sequence.

Operating Voltage
12-36 VDC

Power Capacity
up to 96W at 24V

Operating Temperature Range
from -4°F to +122°F in case



MODEL

RGBW-SR

RGBW-SR - RGBW signal repeater

Extends identical signal when connected in series to an RGBW LED control system. The RGBW signal repeater works with Luminii RGB and RGBW controllers, receivers, and decoders.

RGBW signal can be extended indefinitely when adequate power supply (not included) is connected to the system.

Operating Voltage
12-36 VDC

Power Capacity
up to 96W at 24V

Operating Temperature Range
from -4°F to +122°F in case



MODEL

DDMX-RGBW

DDMX-RGBW - DMX decoder

Translates controller DMX512 programs for RGB and white LED strips.

Unique DMX address for the decoder can be set easily and displayed by the numeric display on the case. Changing and resetting the DMX address requires manual input.

Use power repeater to expand output.

Operating Voltage
12-36 VDC

Power Capacity
up to 96W at 24V

Operating Temperature Range
from -4°F to +122°F in case

Controllers and Decoders



MODEL

TSDMX-E

TSDMX-E - Touchscreen DMX controller

Programmable advanced DMX512 lighting controller featuring a touch-screen interface. Operates as stand alone controller or integrated with most architectural lighting control systems. Can controller endless DMX512 enabled devices.

Mounts to standard single or dual gang wall box with the included power supply inside the junction box. Terminal block design for power and data connections.

Features

- Sleek glass design which sits 0.43" from the wall
- Graphical color display to show selected environment
- Color/dimmer/speed palette
- Color temperature mixing
- Touch sensitive buttons. No mechanical parts
- Touch sensitive wheel allows for accurate color selection
- Multi-zone microSD memory
- Multi-room control with 500 scenes, 10 zones
- 1024 DMX channels. Control 340 RGB fixtures
- USB & Ethernet connectivity for programming and control

Power Supply

7 VDC (included)

Programmability

PC, Mac, Tablet, Smartphone

Output Signal

DMX512 (1024 channels)

Color Parameters

- Brightness
- Saturation
- Speed of color changing sequence
- Fading / dimming / brightness



MODEL

DDMX-5CH-RDM-PRO

DDMX-5CH-RDM-PRO-DMX512 Decoder

DMX512 decoder with RDM functionality features 5 PWM output channels with common anode. High PWM output frequency range allows the product to be used in HD video conferencing spaces. All DMX products to be installed per DMX512 Standard.

Power

96 Watt

Inputs

RJ45, XLR-5Pin, Terminal Block

DMX Channels

1 to 5 settable

PWM Output Resolution Ratio

8 or 16 bit

PWM Output Frequency

500Hz - 30KHz

Output Dimming Curve Gamma Value

0.1 ~ 9.9



MODEL

RGBW-WI-R

RGBW-WI-R - WIFI generator

RGBW-WI-R creates a local network that enables any electronic device (phone, tablet, etc.) to control the RGB/W strip connected to a RGBW-RC-R receiver.

The control functions are achieved through a free application download for Android and iOS devices called REALCOLOR.

Operating Voltage

12-36 VDC

Power Supply

PI-130-24 (included)

Operating Temperature Range

from -4°F to +122°F in case