

Features

The LineLED Monochromatic is a small profile and energy efficient colored light strip available in amber, red, green, blue, yellow, violet, and royal blue. It is easily installed directly on to the mounting surface with double sided tape or within discrete mounting extrusions.



LL42

Mounting

LED strip is equipped with 3M™ adhesive transfer tape (9472LE).

Applications

Indoor only - millwork, cove, architectural reveals, undercabinet, display case, handrail, accent lighting.

Approvals

Class 2 damp listed

Operating voltage

24 VDC

Life (L70)

50,000 hours

Warranty

5 years



Technical information

TYPE	LL42
OUTPUT OPTIONS	HO
Average Power Consumption (for a 4" section)	2.9 W/ft
Cutting Increment (in)	1.97"
Pitch Length	0.28"
Max Run Length (in series)	40 ft
Dimensions	0.39"W x 0.09" H

COLOR	Wavelength	Light Output	Light Color
Red	620-630 nm	77 lm/ft	
Amber	600-610 nm	77 lm/ft	
Yellow	585-595 nm	83 lm/ft	
Green	520-530 nm	296 lm/ft	
Blue	465-475 nm	51 lm/ft	
Royal Blue	445-450 nm	40 lm/ft	
Violet	380-385 nm	91 lm/ft	

Section Start/End Options

SL

Soldered lead wires (72")

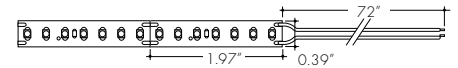

LF

Lead Female 3" cable

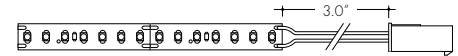

LM

Lead Male 3" cable

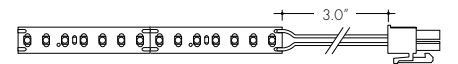

NC

No connector

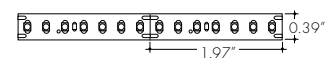

Ordering code

MODEL	OUTPUT	COLOR	SECTION START ²	SECTION END ²	LENGTH
LL42 ¹ - LineLED LL42	HO - High	R - Red A - Amber Y - Yellow G - Green B - Blue RB - Royal Blue V - Violet	SL - Soldered lead wires (72") NC - No connector LM - Lead Male LF - Lead Female	SL - Soldered lead wires (72") NC - No connector LM - Lead Male LF - Lead Female	Ordered in one foot increments. See chart above for max run length.

1 - LL42 monochrome lead time: 8 weeks upon order. Minimum order quantity: 100ft
2 - Additional Connectors and Leads available, see below.

Minii Connectors

Minii connectors are easy, field-installable accessories that make joining LL strip simple! Their minimal width allows them to fit into extrusions, while their transparent frame eliminates dark spots.

Note: verify internal extrusion dimensions to confirm compatibility

LL-PJC-10-03

Jumper minii connector with 3" wire for LL42 LED strip

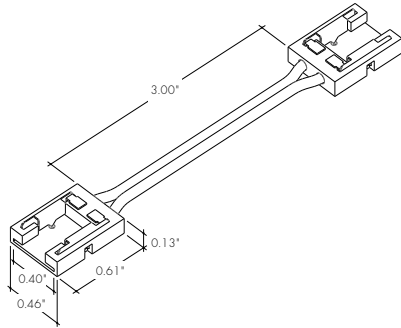

LL-PFC-10-72

Power feed minii connector with 72" wire for LL42 LED strip

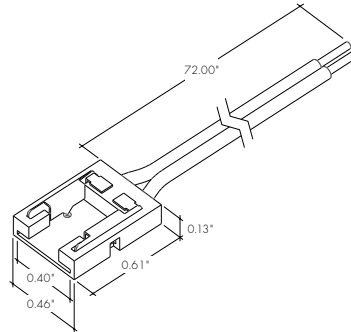

LL-BSC-10

Butt splice minii connector for LL42 LED strip

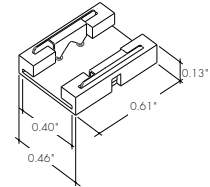

Sample Layout

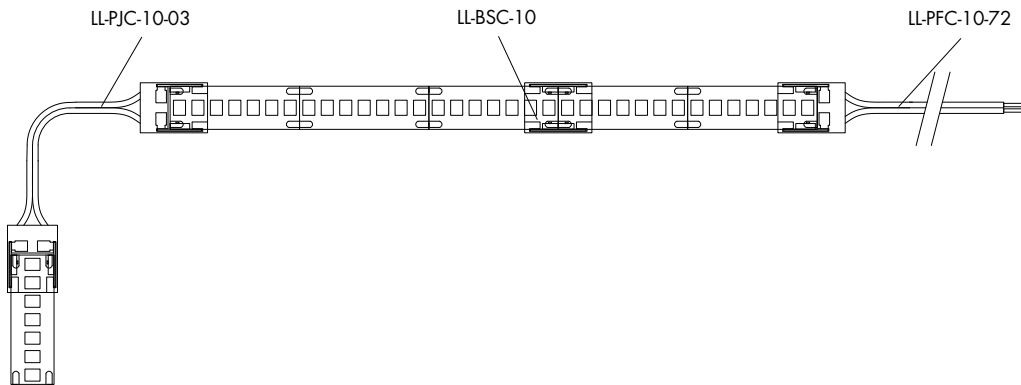

Accessories

CL1

Mounting clip

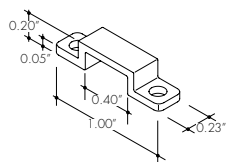

LVSP-4T-BK

Low Voltage, 4 Terminal Splice Box, Black

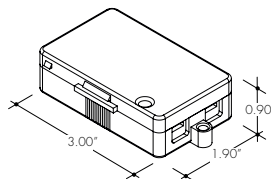

LL.ZIP

Cable/Wire Strain Relief Clip

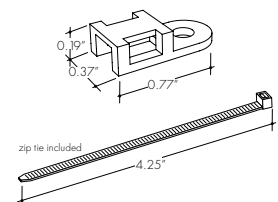

Recommended every 12" when LineLED strip is facing down

Lens Options / Light Transmission



Clear



Half (50%)
Frosted



Graze



Frosted



Flat
Frosted



Raised



Square
Frosted



Round Square
Frosted



13°
13°
Semi-Frosted

*Not compatible with Minii connectors

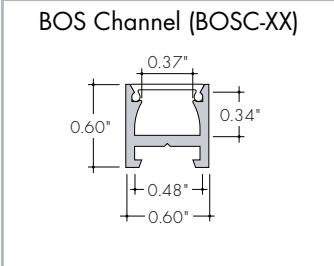

F **SI** **R** **G**
52% 66% 60% 76%

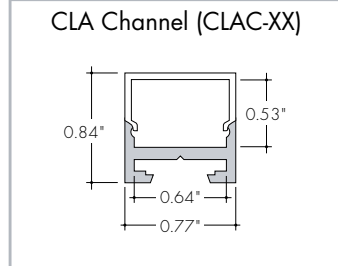

S **Q**
62% 65%

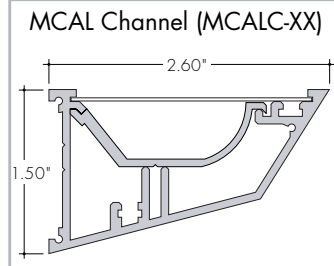

C
94%

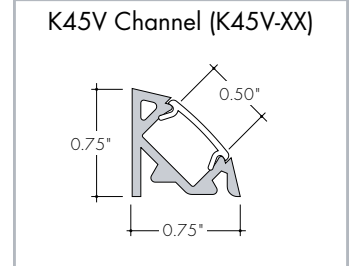

C **HF** **F** **13°**
82% 68% 45% 75%

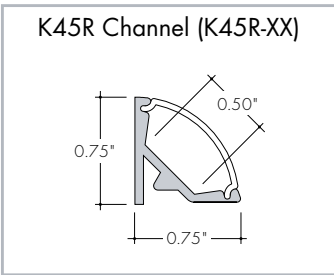

RF
61%

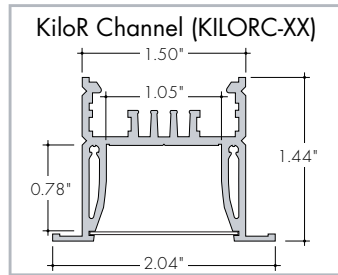

C **F**
85% 75%

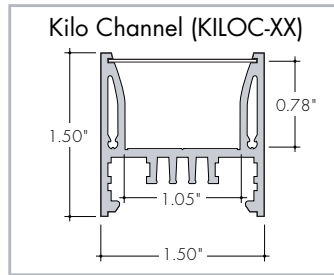

C **F**
85% 75%

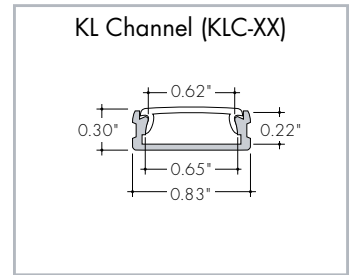

C **HF** **F**
81% 67% 51%

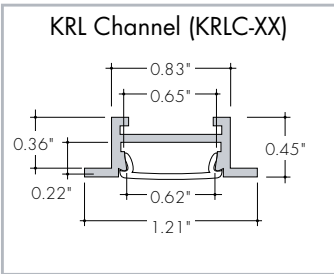

C **HF** **F**
81% 67% 51%

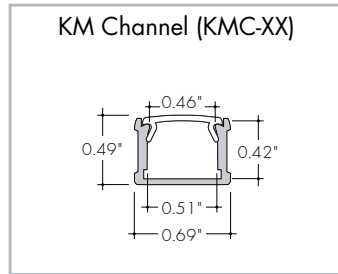

C **HF** **F** **FF** **R** **GR**
82% 68% 45% 52% 58% 56%

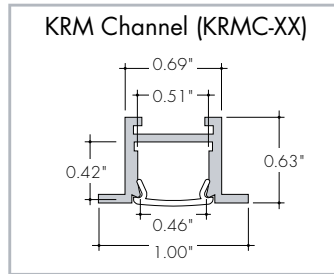

C **HF** **F** **FF** **GR**
82% 68% 45% 52% 56%

*Not compatible with Minii connectors

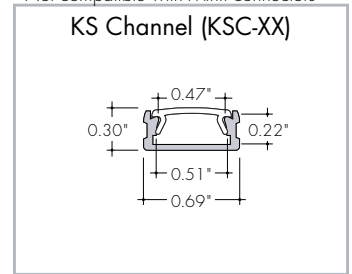

C **HF** **F** **FF** **R** **M**
86% 71% 56% 60% 85% 64%

Installation

All mounting channels are field cuttable using miter saw with circular blade suitable for cutting aluminum.

Ordering

Extrusions are sold separately. View respective specsheets for details on ordering extrusions and their accessories (endcaps, mounting brackets, etc).

Led Dotting per Extrusion

using the frosted lens option

Extrusion	LED Model LL42	LED Model LL72
BOS	ND	ND
CLA	ND	ND
MCAL	ND	ND
K45V	CD	CD
KM	ND	ND
KRM	ND	ND
KS	CD	ND
K45R	ND	ND
KILOR	ND	ND
KILO	ND	ND
KL	CD	ND
KRL	CD	ND

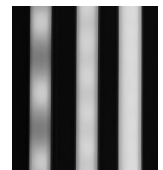

CD **SD** **ND**
CD - Clear Dotting
SD - Slight Dotting
ND - No Dotting

Lens Options / Light Transmission



Clear



Half (50%)
Frosted



Graze



Frosted



Flat
Frosted



Raised



Square
Frosted



Round Square
Frosted



13°
Semi-Frosted

*Not compatible with Minii connectors

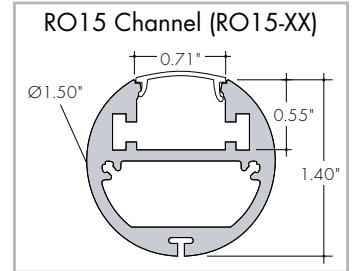
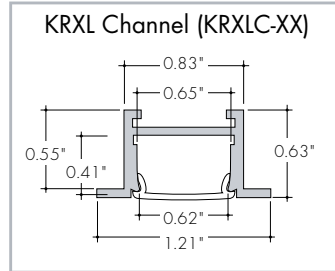
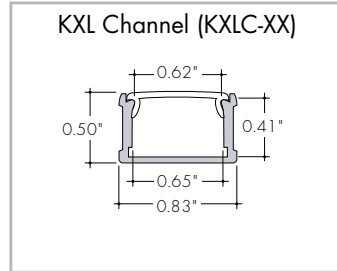
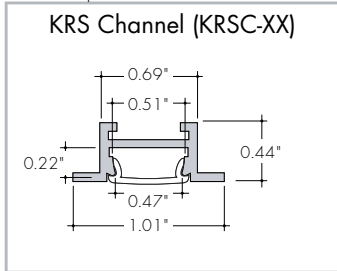

- C**
86%
- HF**
71%
- F**
56%
- FF**
60%
- M**
64%

- C**
79%
- HF**
66%
- F**
49%

- C**
79%
- HF**
66%
- F**
49%

- C**
65%
- F**
41%

*Not compatible with Minii connectors

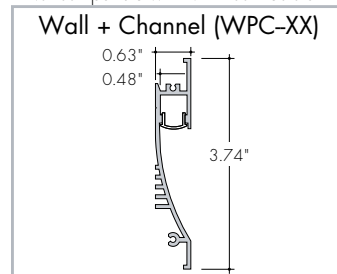
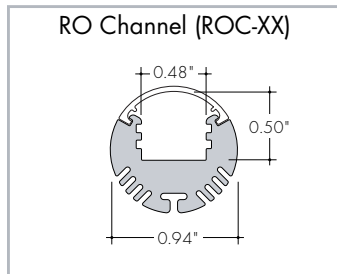

*Not compatible with Minii connectors

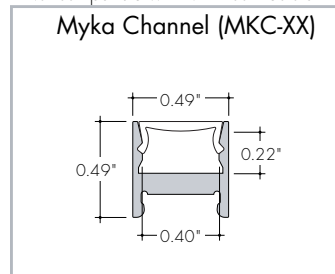

*Not compatible with Minii connectors

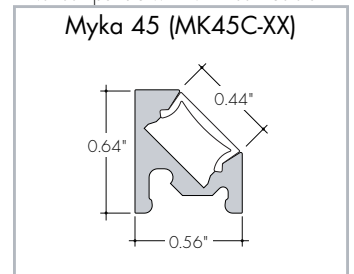

- C**
79%
- F**
50%

- F**
65%

- C**
73%
- F**
61%
- HF**
57%
- MF**
45%
- BLV**
37%
- WLV**
25%

- C**
73%
- F**
61%
- HF**
57%
- MF**
45%
- BLV**
37%
- WLV**
25%

*Not compatible with Minii connectors

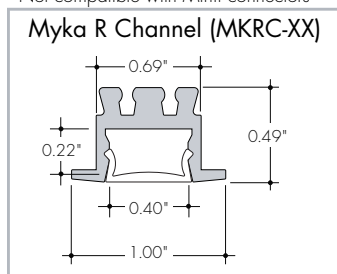

*Not compatible with Minii connectors

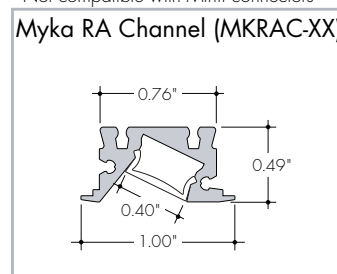

*Not compatible with Minii connectors

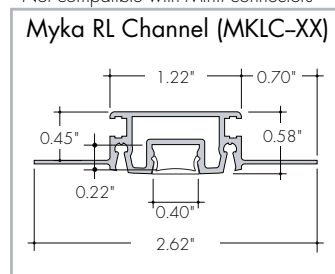

*Not compatible with Minii connectors

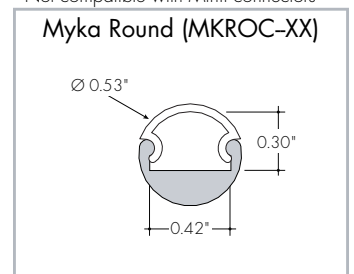

- C**
73%
- F**
61%
- HF**
57%
- MF**
45%
- BLV**
37%
- WLV**
25%

- C**
73%
- F**
61%
- HF**
57%
- MF**
45%
- BLV**
37%
- WLV**
25%

- C**
73%
- F**
61%
- HF**
57%
- MF**
45%
- BLV**
37%
- WLV**
25%

- RF**
57%

Led Dotting per Extrusion

using the frosted lens option

Extrusion	LED Model LL42	LED Model LL72
KRS	CD	ND
KXL	ND	ND
KRXL	ND	ND
RO15	ND	ND
RO	ND	ND
WP	SD	SD
MK	SD	ND
MK45	SD	ND
MKR	SD	ND
MKRA	SD	ND
MKLC	SD	ND
MKRO	ND	ND

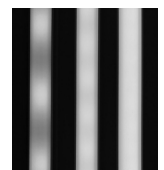

CD SD ND
CD - Clear Dotting
SD - Slight Dotting
ND - No Dotting

Installation

All mounting channels are field cuttable using miter saw with circular blade suitable for cutting aluminum.

Ordering

Extrusions are sold separately. View respective specsheets for details on ordering extrusions and their accessories (endcaps, mounting brackets, etc).

Power Consumption

Tested at full power with PDC Series power supplies.

Nominal Length (in)	LL42-HO	
	W/ft	Total Wattage
1	2.9	2.9
2	2.9	5.9
3	2.9	8.3
4	2.9	11.2
5	2.9	14.4
6	2.9	17.8
7	2.9	20.9
8	2.9	23.3
9	2.8	25.5
10	2.8	28.1
11	2.8	30.5
12	2.7	32.9
13	2.7	35.6
14	2.7	38.0
15	2.7	40.6
16	2.5	40.8
17	2.5	42.9
18	2.5	45.3
19	2.5	47.4
20	2.4	48.7
21	2.4	49.8
22	2.4	53.0
23	2.3	53.7
24	2.3	55.6
25	2.3	58.2
26	2.3	58.4
27	2.2	59.9
28	2.2	62.3
29	2.2	64.4
30	2.2	66.4
31	2.1	66.4
32	2.2	69.1
33	2.1	70.8
34	2.1	71.5
35	2.1	73.1
36	2.2	80.1
37	2.2	82.6
38	2.2	82.7
39	2.2	84.7
40	2.1	85.2

Voltage Drop Calculator

The below chart assumes nominal voltage of 24 Volts and a Voltage Drop Allowance of 3% through the wire

Wattage [W]	Maximum Wire Length From Power Supply to Start of Run [ft]						
	12 AWG	14 AWG	16 AWG	18 AWG	20 AWG	22 AWG	24 AWG
5	1088.2	684.4	430.3	270.6	170.2	107.1	67.3
10	544.1	342.2	215.1	135.3	85.1	53.5	33.7
15	362.7	228.1	143.4	90.2	56.7	35.7	22.4
20	272.0	171.1	107.6	67.7	42.6	26.8	16.8
25	217.6	136.9	86.1	54.1	34.0	21.4	13.5
30	181.4	114.1	71.7	45.1	28.4	17.8	11.2
35	155.5	97.8	61.5	38.7	24.3	15.3	9.6
40	136.0	85.5	53.8	33.8	21.3	13.4	8.4
45	120.9	76.0	47.8	30.1	18.9	11.9	7.5
50	108.8	68.4	43.0	27.1	17.0	10.7	6.7
55	98.9	62.2	39.1	24.6	15.5	9.7	6.1
60	90.7	57.0	35.9	22.6	14.2	8.9	5.6
65	83.7	52.6	33.1	20.8	13.1	8.2	5.2
70	77.7	48.9	30.7	19.3	12.2	7.6	4.8
75	72.5	45.6	28.7	18.0	11.3	7.1	4.5
80	68.0	42.8	26.9	16.9	10.6	6.7	4.2
85	64.0	40.3	25.3	15.9	10.0	6.3	4.0
90	60.5	38.0	23.9	15.0	9.5	5.9	3.7
96	56.7	35.6	22.4	14.1	8.9	5.6	3.5

Power Supplies

See Power Supply instructions and spec sheet for wiring information. For a complete list of compatible dimmers, see Compatible Dimming Chart on the Resources page.

0-10V Dimming Power Supplies 0.1% 120VAC - 277VAC

MODEL	POWER	OUTPUT	DIMMING
PS010V - 0-10V Power Supply dims down to 0.1%	96 - 96 Watt 3X96 - 3 X 96 Watt	24 - 24 VDC	LIN - Linear LOG - Logarithmic

MODELS	96W	3X96
Length	14.40"	13.00"
Width	5.20"	6.62"
Depth	2.60"	4.20"

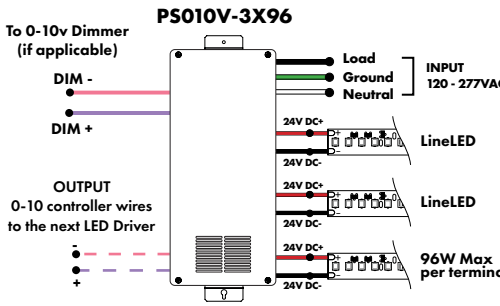
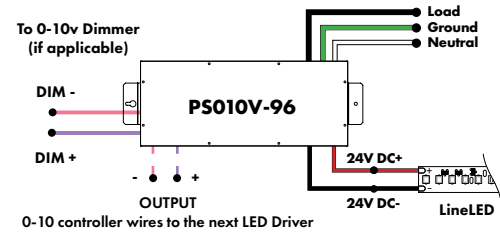

DALI 0% Dimming Power Supplies 120VAC - 277VAC

MODEL	POWER	OUTPUT
PSDALI - DALI Power Supply dims down to 0%	96 - 96 Watt 3X96 - 3 X 96 Watt	24 - 24 VDC

Features eldoLED's LINEARdrive configurable dimmable drivers

Model	96W	3X96
Length	14.40"	13.00"
Width	5.20"	6.62"
Depth	2.60"	4.20"

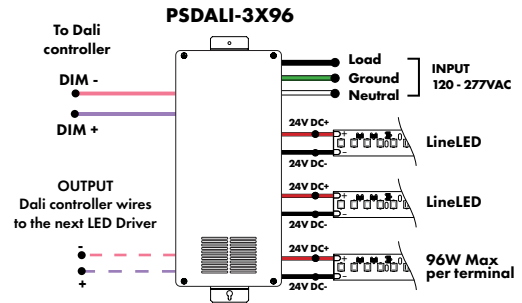
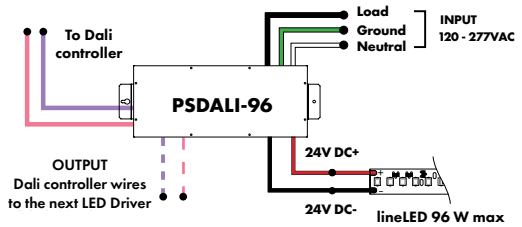

Universal Power Supply 1% 120VAC - 277VAC

MODEL	POWER	OUTPUT
PDCU-D - IP20 Dry Series	30 - 30 W 60 - 60 W 96 - 96 W 3X96 - 3X96 W	24 - 24 VDC
PDCU-W - IP66 Wet Series	96 - 96 W 3X96 - 3X96 W	

0-10V dims down to 1%, MLV/ELV/TRIAC dims down to 1%.
For a complete list of compatible dimmers, see [Compatible Dimming Chart](#) on the Resources page.

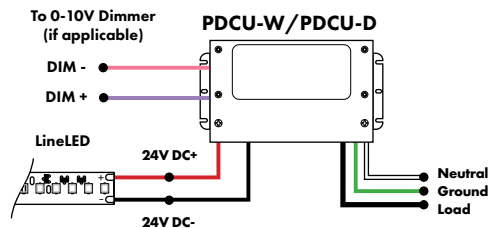

MODEL	PDCU-W-96W	PDCU-W-3X96W	PDCU-D-30W	PDCU-D-60W	PDCU-D-96W	PDCU-D-3X96W
Length	8.66"	11.85"	6.10"	7.93"	8.25"	9.57"
Width	3.73"	4.32"	3.35"	3.35"	4.10"	5.94"
Depth	1.61"	1.81"	1.33"	1.32"	1.56"	1.13"

Power Supplies

See Power Supply instructions and spec sheet for wiring information. For a complete list of compatible dimmers, see Compatible Dimming Chart on the Resources page.

Customizable Dim to Warm or Variable White via 0 - 10V
(for tunable white or warm dimming control of Dynamic option)

MODEL	POWER	OUTPUT	CONTROL
PS010VD-0-10V Vintage Dim LED Driver	96-96 Watt	24-24 VDC	W2I-Standard dimming for both tapes

*Zonal control power supplies

MODELS	96W
Length	14.40"
Width	5.20"
Depth	2.60"

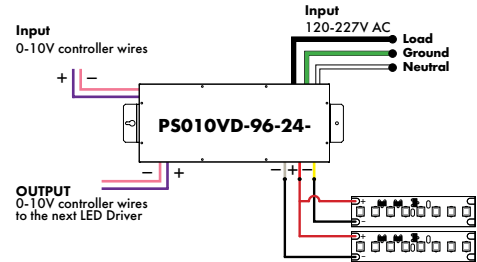

Non-Dimming Power Supply 120VAC - 277VAC

MODEL	POWER	OUTPUT	DIMMING	LOCATION
PSV - PSV Series	96 - 96 Watt	24 - 24 VDC	ND - Non Dimming	D - Damp

MODELS	96W
Length	8.25"
Width	3.75"
Depth	1.63"

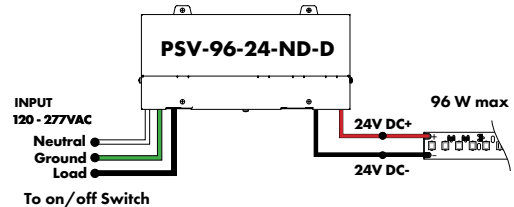

Enlighted Enabled Dimming Power Supplies 120VAC - 277VAC

MODEL	POWER	OUTPUT	DIMMING	LOCATION
PSV - PSV Series	96 - 96 Watt	24 - 24 VDC	ENL - Enlighted Dimming dims down to 0%	D - Damp

Model	96W
Length	14.40"
Width	5.20"
Depth	2.60"

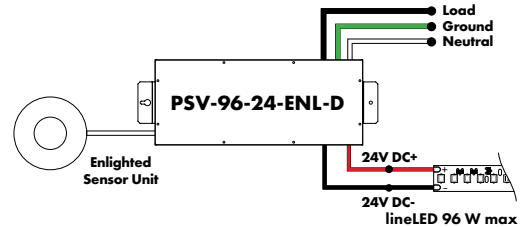

Triac, MLV, ELV Compatible Dimmers

MODEL	POWER	OUTPUT
PDC - (IP20) Power Supply	96 - 96 Watts	24 - 24 VDC

MODELS	96W
Length	8.25"
Width	4.10"
Depth	1.56"

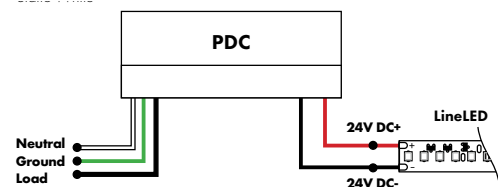

Power Supplies

See Power Supply instructions and spec sheet for wiring information. For a complete list of compatible dimmers, see Compatible Dimming Chart on the Resources page.

In-Ground Power Supplies

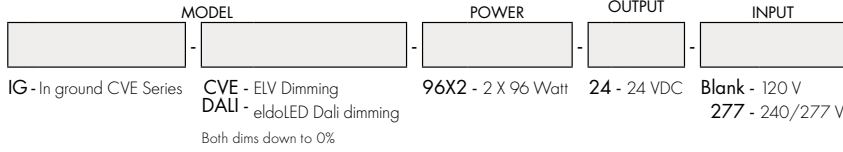

MODEL	Dual Circuit
Length	8.40"
Width	8.30"
Depth	8.10"

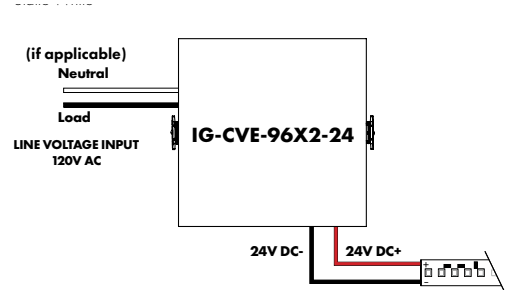

Luminii is a Lutron OEM Advantage Partner

Lutron Power Supplies 0.1%

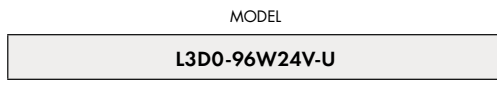

HiLume™ 0.1% EcoSystem Voltage LED Driver with Soft-On, Fade-to-Black™ 96W max

MODELS	L3D0
Length	10.50"
Width	5.50"
Depth	2.00"

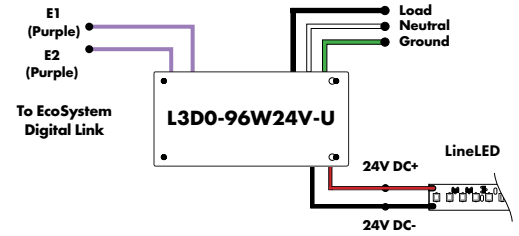

DMX Dimming Power Supplies 120VAC - 277VAC

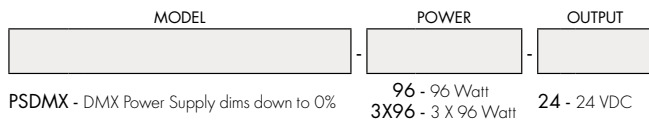

Features eldoLED's LINEARdrive configurable dimmable drivers

*Zonal control power supplies. Control multiple tapes/zones using DMX channels.

MODEL	96W	3X96
Length	14.40"	13.00"
Width	5.20"	6.60"
Depth	2.60"	4.20"

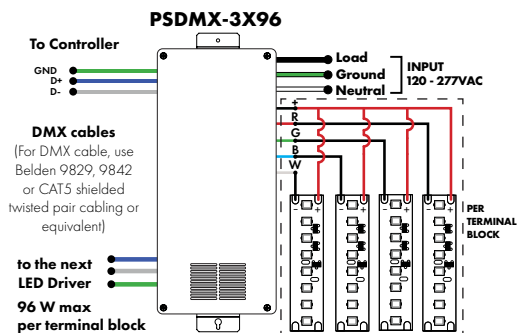
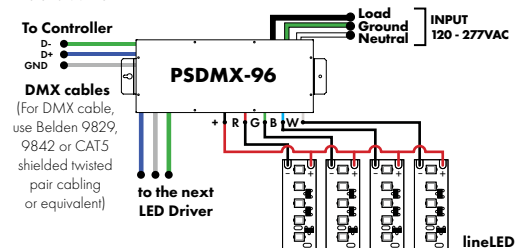

Decoders



MODEL

DDMX-5CH-RDM-PRO

DDMX-5CH-RDM-PRO-DMX512 Decoder

DMX512 decoder with RDM functionality features 5 PWM output channels with common anode. High PWM output frequency range allows the product to be used in HD video conferencing spaces. All DMX products to be installed per DMX512 Standard.

Power
96 Watt

Inputs
RJ45, XLR-5Pin, Terminal Block

DMX Channels
1 to 5 settable

PWM Output Resolution Ratio
8 or 16 bit

PWM Output Frequency
500Hz - 30KHz

Output Dimming Curve Gamma Value
0.1 ~ 9.9



MODEL

DDMX-RGBW

DDMX-RGBW - DMX512 Decoder

Translates controller DMX512 programs for RGB and white LED strips.

Unique DMX address for the decoder can be set easily and displayed by the numeric display on the case. Changing and resetting the DMX address requires manual input.

Use power repeater to expand output (Luminii part# RGBW-SR).

Operating Voltage
12-36 VDC

Power Capacity
up to 96W at 24V

Operating Temperature Range
from -4°F to +122°F in case

PWM Output Frequency
200Hz or 1500Hz



MODEL

RGBW-RC-R

RGBW-RC-R - RGBW receiver

The RGBW receiver is easily paired with controller by the click of a button. Receiver can be reset to factory settings at any time.

Each receiver can store one static RGB color, one color sequence, and one brightness setting for the white LED strip. Receivers assigned to the same scene within the same zone will have the same LED static color and color sequence.

Operating Voltage
12-36 VDC

Power Capacity
up to 96W at 24V

Operating Temperature Range
from -4°F to +122°F in case

Decoders



MODEL

RGBW-SR

RGBW-SR - RGBW signal repeater

Extends identical signal when connected in series to an RGBW LED control system. The RGBW signal repeater works with Luminii RGB and RGBW controllers, receivers, and decoders.

RGBW signal can be extended indefinitely when adequate power supply (not included) is connected to the system.

Operating Voltage
12-36 VDC

Power Capacity
up to 96W at 24V

Operating Temperature Range
from -4°F to +122°F in case



MODEL

RGBW-WiR

RGBW-WiR - WiFi generator

RGBW-WiR creates a local network that enables any electronic device (phone, tablet, etc.) to control the RGB/W strip connected to a RGBW-RC-R receiver.

The control functions are achieved through a free application download for Android and iOS devices called REALCOLOR.

Operating Voltage
12-36 VDC

Power Supply
PI-130-24 (included)

Operating Temperature Range
from -4°F to +122°F in case

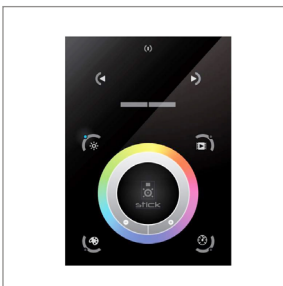

MODEL

TSDMX-E

TSDMX-E - Touchscreen DMX controller

Programmable advanced DMX512 lighting controller featuring a touch-screen interface. Operates as stand alone controller or integrated with most architectural lighting control systems. Can controller endless DMX512 enabled devices.

Mounts to standard single or dual gang wall box with the included power supply inside the junction box. Terminal block design for power and data connections.

Features

- Sleek glass design which sits 0.43" from the wall
- Graphical color display to show selected environment
- Color/dimmer/speed palette
- Color temperature mixing
- Touch sensitive buttons. No mechanical parts
- Touch sensitive wheel allows for accurate color selection
- Multi-zone microSD memory
- Multi-room control with 500 scenes, 10 zones
- 1024 DMX channels. Control 340 RGB fixtures
- USB & Ethernet connectivity for programming and control

Power Supply

7 VDC (included)

Programmability

PC, Mac, Tablet, Smartphone

Output Signal

DMX512 (1024 channels)

Color Parameters

- Brightness
- Saturation
- Speed of color changing sequence
- Fading / dimming / brightness