

Features

Kurba Small is a direct view, small profile, energy efficient and flexible LED strip suitable for outdoor wet locations capable of horizontal/side bends and vertical/top bends with a 2" bending radius. The silicone material offers excellent heat, weather, UV, and solvent resistance and has a special coating to repel dust and dirt accumulation.

Applications

Indoor/Outdoor dry & wet location

Materials

Silicone for red list approved, as well as heat, weather, UV, and solvent resistance

Dimming

Dot Free even illumination. Also available with Black Lens

Average Life (L70)

50,00 Hours

Approvals

24VDC Class 2 wet listed, IP67

Warranty

3 years

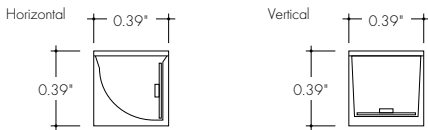

Finish Options (see page 2 for additional information)

Base White

Premium Black



Technical Information

Bending Direction	Horizontal		Vertical		60SO (Black Lens Only)	CCT INFO / LUMEN MULTIPLIER	
	44SO	44HO	44SO	44HO		Color Temperature	Multiplier (ref. -3000K)
Output							
Light Output at 3000K	85 lm/ft	163 lm/ft	96 lm/ft	180 lm/ft	16 lm/ft	2200K	0.93
Average Power Consumption at 4'	1.37 W/ft	2.74 W/ft	1.37 W/ft	2.74 W/ft	1.37 W/ft	2400K	1.00
Efficacy	62 lm/W	59 lm/W	70 lm/W	66 lm/W	12 lm/W	2700K	1.00
Ordering Increment	3.28"		3.28"		1.4"	3000K	1.06
Maximum Run Length (In Series)	49'	24'	49'	24'	33'	3500K	1.06
Operating Temperature	-40°F to 149°F	-40°F to 131°F	-40°F to 149°F	-40°F to 131°F	-40°F to 149°F	4000K	1.00

Note: 80 CRI

Constraints

Horizontal Bend Direction

Bend LED in these positions only to avoid damage

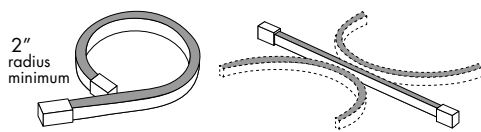

Illuminated surface shown in gray

Horizontal Prohibited Bends

Twisting or bending LED in these positions will cause damage

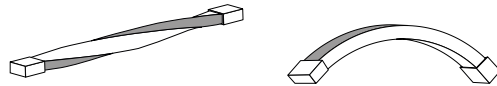

Illuminated surface shown in gray

Do not make sharp bends near the endcap

Vertical Bend Direction

Bend LED in these positions only to avoid damage

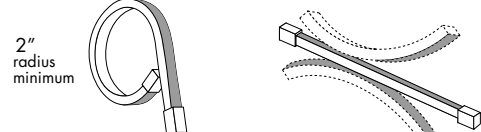

Illuminated surface shown in gray

Vertical Prohibited Bends

Twisting or bending LED in these positions will cause damage

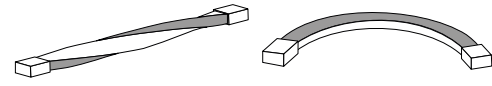

Illuminated surface shown in gray

Do not make sharp bends near the endcap

Ordering Code

MODEL	RATING	BEND DIRECTION	LENGTH	OUTPUT ¹	CCT	LENS ²	MOUNTING	FINISH	FEED POSITION LEFT	FEED POSITION RIGHT
KBS - Kurba Small	W - Wet	HB - Horizontal Bending VB - Vertical Bending	SEE PCC CHART ON PAGES 6 AND 8	44SO - Standard 44HO - High	22K - 2200K 24K - 2400K 27K - 2700K 30K - 3000K 35K - 3500K 40K - 4000K	SF - Silicone Frosted	NA - See Page 4 for orderable mounting accessories	WH - White	INJECTION MOLD IME - End Feed 1 IMB - Back Feed 1 IMSA - Side 1 Feed IMSB - Side 2 Feed ³ NPF - No Power Feed ⁴	INJECTION MOLD IME - End Feed 1 IMB - Back Feed 1 IMSA - Side 1 Feed IMSB - Side 2 Feed ³ NPF - No Power Feed ⁴
				60SO - Standard	26K - 2600K 42K - 4200K	BL - Black Lens ²	NA - See Page 4 for orderable mounting accessories	BK - Black	Feeds come with 118" wire leads	

1 - Title 24 JA8 compliance achievable, contact factory for specific requests
2 - BL Lens only available with VB - Vertical Bend Direction

3 - IMSB - Side 2 Feed not available with HB - Horizontal Bending
4 - NPF-NPF for Feed Position 1&2 is not a valid configuration option

Powerfeeds and Connectors

Power Feed Position Options and Orientation

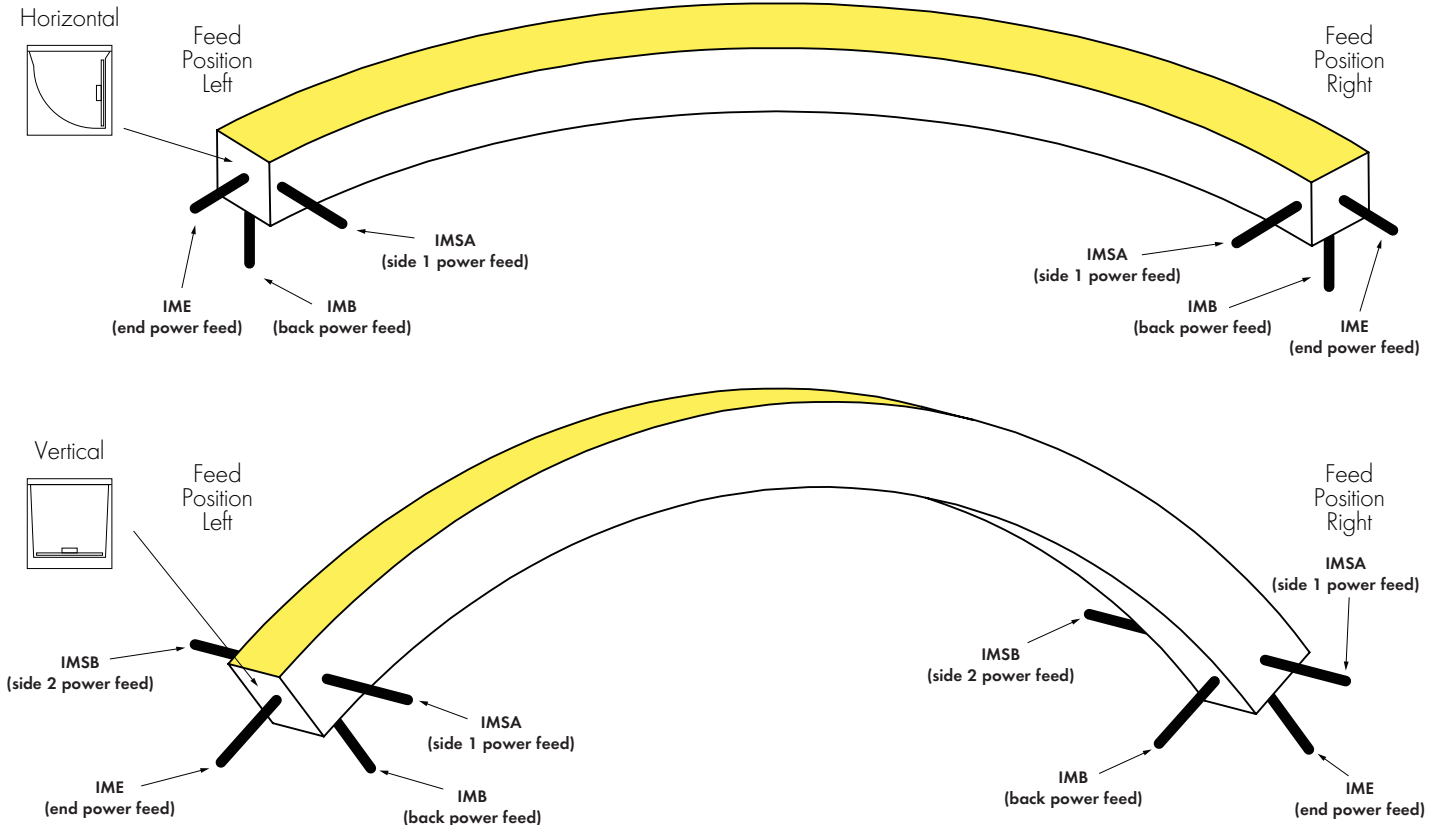

NOTE: IMSB - Side 2 Feed not available with HB - Horizontal Bending

Linking and Extension Cable Options

END CONNECTOR

Injection-molded End Connector
-IME

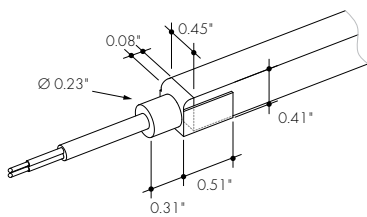

BACK CONNECTOR

Injection-molded Back Connector
-IMB

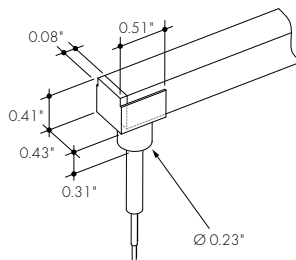

SIDE CONNECTOR

Injection-molded Side Connector
-IMSA and -IMSB

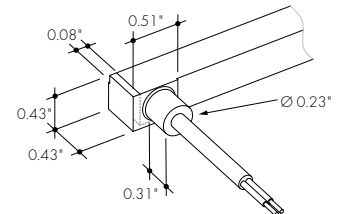

ENDCAP (NO CONNECTOR)

Injection-molded Cap (No Connector)
-NPF

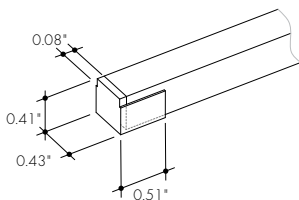

ANTI-WICKING FERRULE

Included on every power feed wire

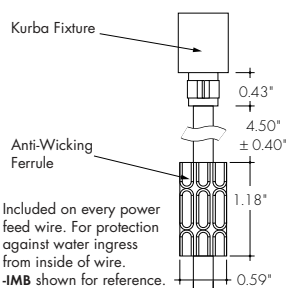

Product Dimensions

Kurba Small Cross Sections

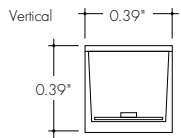
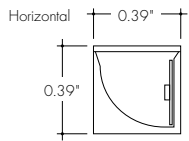

Example Feed Position
IME - NPF
 End Feed 1 to
 No Power Feed

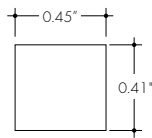

Example Feed Position
IMSA - NPF
 Side 1 Feed to
 No Power Feed

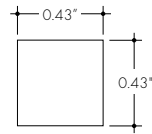

Example Feed Position
IMB - NPF
 Back Feed 1 to
 No Power Feed

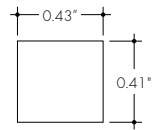

Example Feed Position
IME - IME
 End Feed 1 and
 End Feed 1

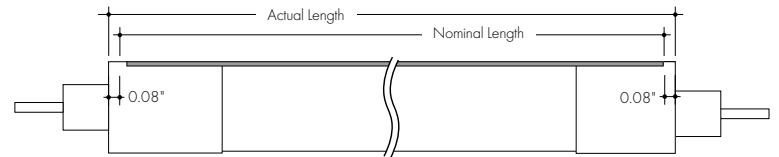
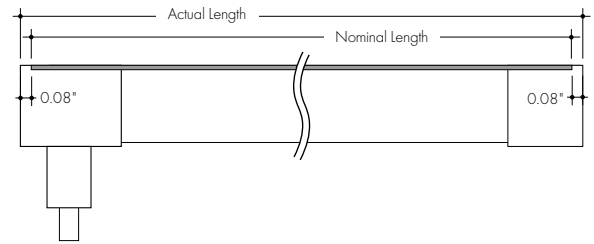
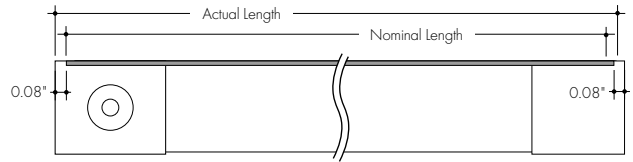
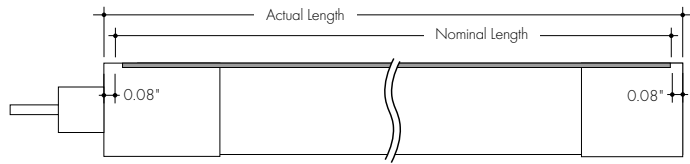
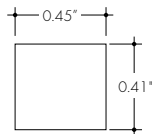

Finish Options

- Kurba's base finish is a crisp white which brings a timeless, clean aesthetic that brightens and enhances any space.
- Also available with a blackout aesthetic - the Black Lens paired with the Black Finish provides for a sleek, all black profile that keeps the strip concealed in the off-state.

White Base

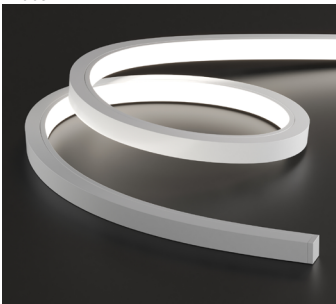

Black Finish w/ Black Lens Premium



Light Transmission and Dotting

Output Options	Lens/Accessory	
	Silicone Frosted/ White Finish	Black Lens/ Black Finish
44SO	ND	N/A
44HO	ND	N/A
60SO	N/A	ND
Transmission Percentage	100%	100%



CD - Clear Dotting
SD - Slight Dotting
ND - No Dotting

Mounting Accessories & Optional Connectors

MC-KBS-SAP-SM-0.8-SA

KBS Mounting Channel, Serrated Aluminum Profile, Surface Mount, 0.8in, Silver Anodized

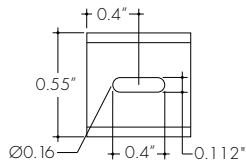
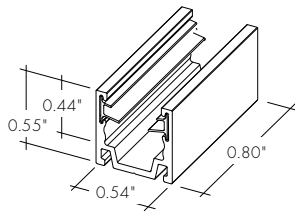

Aluminum mounting bracket providing grip. For use with light strip mounted to the ceiling. 1 recommended every 8 in.

MC-KBS-SAP-SM-78-SA

KBS Mounting Channel, Serrated Aluminum Profile, Surface Mount, 78in, Silver Anodized

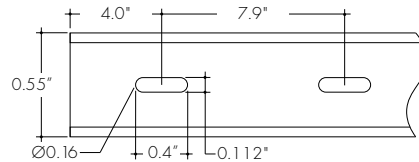
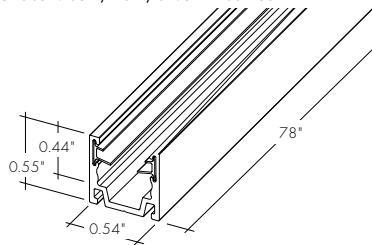

Aluminum mounting channel providing grip. For use with light strip mounted to the ceiling.

MC-KBS-FSAP-TR-78-SA

KBS Mounting Channel, Flanged Serrated Aluminum Profile, Trimmed Recessed Mount, 78in, Silver Anodized

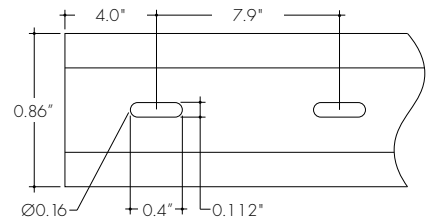
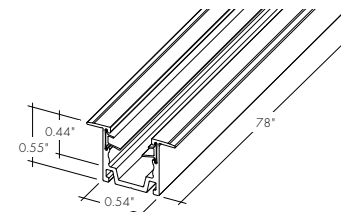

Flanged aluminum mounting channel providing grip. For use with light strip mounted to the ceiling.

MC-KBS-BSAP-HB-SM-38-SA

KBS Mounting Channel, Bendable Serrated Aluminum Profile, Horizontal Bending, Surface Mount, 38in, Silver Anodized

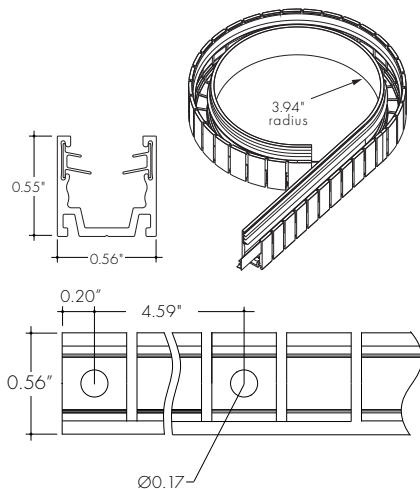

For use with light strip mounted to the ceiling.
NOTE: For use with **HB** - Horizontal Bend only. Mounting Channel Bending Radius is 7.87" in opposite direction

LVSP-WET

Splice box: wet rated, low voltage, gray

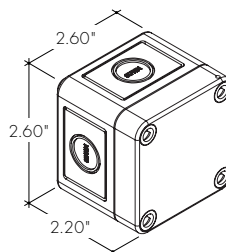

LVSP-WET-CM

Connector for splice box, low voltage for cable management, gray

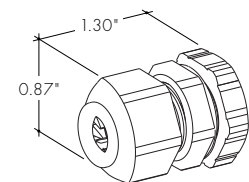

Photometry

KBS-W-HB-48-44HO-30K-SF-NA-WH

Kurba Small, Horizontal Bend, 4ft, 3000K, 44HO, Silicone Frosted Lens

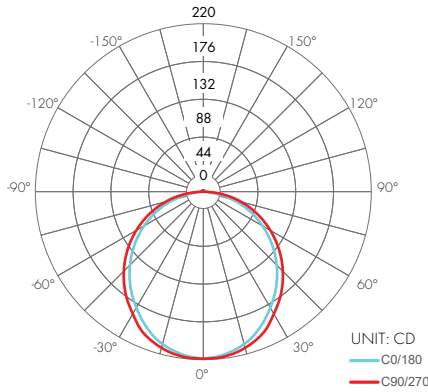

Zonal Lumen Summary 3000K

Zone	Lumen	% Fixture
0-30	170	26.0%
0-40	233	35.7%
0-60	491	75.2%
0-90	639	98.0%
Total	652	100.0%

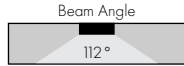

KBS-W-VB-48-44HO-30K-SF-NA-WH

Kurba Small, Vertical Bend, 4ft, 3000K, 44HO, Silicone Frosted Lens

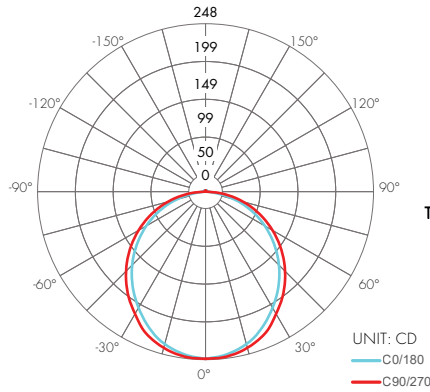

Zonal Lumen Summary 3000K

Zone	Lumen	% Fixture
0-30	191	26.5%
0-40	262	36.4%
0-60	552	76.6%
0-90	709	98.5%
Total	720	100.0%

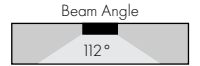

44SO | Power Consumption Per Fixture Length

Based on operation with PDCU series of power supplies. Use Acutal Length for Order Code Entry
 Tolerance for Actual Lengths less than 6 ft is +/- 0.2", Actual Lengths between 6 ft and 16 ft is +/- 0.3", and Actual Lengths greater than 16 ft is +/- 0.6"

Nominal Length (in)	W	Actual Length (in)	Nominal Length (in)	W	Actual Length (in)	Nominal Length (in)	W	Actual Length (in)	Nominal Length (in)	W	Actual Length (in)	Nominal Length (in)	W	Actual Length (in)
7	0.8	6.7	125	14.3	124.8	243	27.8	242.9	(30 ft) 361	41.3	361.0	(40 ft) 479	54.8	479.1
10	1.1	10.0	128	14.6	128.1	246	28.1	246.2	365	41.7	364.3	483	55.2	482.4
(1 ft) 14	1.5	13.3	(11 ft) 132	15.0	131.4	250	28.5	249.5	368	42.0	367.6	486	55.5	485.7
17	1.9	16.6	135	15.4	134.7	(21 ft) 253	28.9	252.8	(31 ft) 371	42.4	370.9	489	55.9	489.0
20	2.3	19.8	138	15.8	137.9	256	29.3	256.1	374	42.8	374.2	(41 ft) 493	56.3	492.3
(2 ft) 23	2.6	23.1	141	16.1	141.2	260	29.6	259.3	378	43.2	377.4	496	56.7	495.5
27	3.0	26.4	(12 ft) 145	16.5	144.5	(22 ft) 263	30.0	262.6	381	43.5	380.7	499	57.0	498.8
30	3.4	29.7	148	16.9	147.8	266	30.4	265.9	(32 ft) 384	43.9	384.0	502	57.4	502.1
33	3.8	33.0	151	17.3	151.1	269	30.8	269.2	388	44.3	387.3	(42 ft) 506	57.8	505.4
(3 ft) 36	4.1	36.2	(13 ft) 155	17.6	154.4	273	31.2	272.5	391	44.7	390.6	509	58.2	508.7
40	4.5	39.5	158	18.0	157.6	(23 ft) 276	31.5	275.7	394	45.0	393.8	512	58.5	512.0
43	4.9	42.8	161	18.4	160.9	279	31.9	279.0	(33 ft) 397	45.4	397.1	(43 ft) 515	58.9	515.2
46	5.3	46.1	164	18.8	164.2	282	32.3	282.3	401	45.8	400.4	519	59.3	518.5
(4 ft) 50	5.6	49.4	(14 ft) 168	19.1	167.5	286	32.7	285.6	404	46.2	403.7	522	59.7	521.8
53	6.0	52.7	171	19.5	170.8	(24 ft) 289	33.0	288.9	(34 ft) 407	46.5	407.0	525	60.0	525.1
56	6.4	55.9	174	19.9	174.0	292	33.4	292.1	410	46.9	410.2	(44 ft) 529	60.4	528.4
(5 ft) 59	6.8	59.2	178	20.3	177.3	296	33.8	295.4	414	47.3	413.5	532	60.8	531.6
63	7.1	62.5	(15 ft) 181	20.6	180.6	(25 ft) 299	34.2	298.7	417	47.7	416.8	535	61.2	534.9
66	7.5	65.8	184	21.0	183.9	302	34.5	302.0	(35 ft) 420	48.0	420.1	(45 ft) 538	61.5	538.2
69	7.9	69.1	187	21.4	187.2	305	34.9	305.3	424	48.4	423.4	542	61.9	541.5
(6 ft) 73	8.3	72.3	(16 ft) 191	21.8	190.4	309	35.3	308.5	427	48.8	426.7	545	62.3	544.8
76	8.6	75.6	194	22.1	193.7	(26 ft) 312	35.7	311.8	430	49.2	429.9	548	62.7	548.0
79	9.0	78.9	197	22.5	197.0	315	36.0	315.1	(36 ft) 433	49.5	433.2	(46 ft) 552	63.0	551.3
(7 ft) 82	9.4	82.2	200	22.9	200.3	319	36.4	318.4	437	49.9	436.5	555	63.4	554.6
86	9.8	85.5	(17 ft) 204	23.3	203.6	322	36.8	321.7	440	50.3	439.8	558	63.8	557.9
89	10.1	88.7	207	23.6	206.8	(27 ft) 325	37.2	325.0	(37 ft) 443	50.7	443.1	561	64.2	561.2
92	10.5	92.0	210	24.0	210.1	328	37.5	328.2	447	51.0	446.3	(47 ft) 565	64.5	564.4
(8 ft) 96	10.9	95.3	214	24.4	213.4	332	37.9	331.5	450	51.4	449.6	568	64.9	567.7
99	11.3	98.6	(18 ft) 217	24.8	216.7	(28 ft) 335	38.3	334.8	453	51.8	452.9	571	65.3	571.0
102	11.6	101.9	220	25.1	220.0	338	38.7	338.1	(38 ft) 456	52.2	456.2	(48 ft) 575	65.7	574.3
105	12.0	105.1	223	25.5	223.2	342	39.0	341.4	460	52.5	459.5	578	66.0	577.6
(9 ft) 109	12.4	108.4	(19 ft) 227	25.9	226.5	345	39.4	344.6	463	52.9	462.7	581	66.4	580.8
112	12.8	111.7	230	26.3	229.8	(29 ft) 348	39.8	347.9	466	53.3	466.0	584	66.8	584.1
115	13.1	115.0	233	26.6	233.1	351	40.2	351.2	(39 ft) 470	53.7	469.3	(49 ft) 588	67.2	587.4
(10 ft) 118	13.5	118.3	237	27.0	236.4	355	40.5	354.5	473	54.0	472.6			
122	13.9	121.5	(20 ft) 240	27.4	239.7	358	40.9	357.8	476	54.4	475.9			

Note: all values are rounded to the nearest 0.1 inch

Endcap (No Connector) -NPF

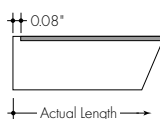

End Connector -IME

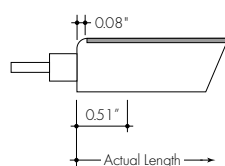

Back Connector -IMB

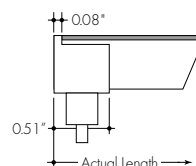

Side Connector -IMSA and -IMSB

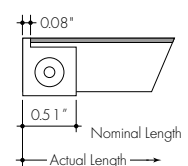

44HO | Power Consumption Per Fixture Length

Based on operation with PDCU series of power supplies. Use Actual Length for Order Code Entry
 Tolerance for Actual Lengths less than 6 ft is +/- 0.2", Actual Lengths between 6 ft and 16 ft is +/- 0.3", and Actual Lengths greater than 16 ft is +/- 0.6"

Nominal Length (in)	W	Actual Length (in)	Nominal Length (in)	W	Actual Length (in)	Nominal Length (in)	W	Actual Length (in)
7	1.5	6.7	125	28.5	124.8	243	55.5	242.9
10	2.3	10.0	128	29.3	128.1	246	56.3	246.2
(1 ft) 14	3.0	13.3	(11 ft) 132	30.0	131.4	250	57.0	249.5
17	3.8	16.6	135	30.8	134.7	(21 ft) 253	57.8	252.8
20	4.5	19.8	138	31.5	137.9	256	58.5	256.1
(2 ft) 23	5.3	23.1	141	32.3	141.2	260	59.3	259.3
27	6.0	26.4	(12 ft) 145	33.0	144.5	(22 ft) 263	60.0	262.6
30	6.8	29.7	148	33.8	147.8	266	60.8	265.9
33	7.5	33.0	151	34.5	151.1	269	61.5	269.2
(3 ft) 36	8.3	36.2	(13 ft) 155	35.3	154.4	273	62.3	272.5
40	9.0	39.5	158	36.0	157.6	(23 ft) 276	63.1	275.7
43	9.8	42.8	161	36.8	160.9	279	63.8	279.0
46	10.5	46.1	164	37.5	164.2	282	64.6	282.3
(4 ft) 50	11.3	49.4	(14 ft) 168	38.3	167.5	286	65.3	285.6
53	12.0	52.7	171	39.0	170.8	(24 ft) 289	66.1	288.9
56	12.8	55.9	174	39.8	174.0			
(5 ft) 59	13.5	59.2	178	40.5	177.3			
63	14.3	62.5	(15 ft) 181	41.3	180.6			
66	15.0	65.8	184	42.0	183.9			
69	15.8	69.1	187	42.8	187.2			
(6 ft) 73	16.5	72.3	(16 ft) 191	43.5	190.4			
76	17.3	75.6	194	44.3	193.7			
79	18.0	78.9	197	45.0	197.0			
(7 ft) 82	18.8	82.2	200	45.8	200.3			
86	19.5	85.5	(17 ft) 204	46.5	203.6			
89	20.3	88.7	207	47.3	206.8			
92	21.0	92.0	210	48.0	210.1			
(8 ft) 96	21.8	95.3	214	48.8	213.4			
99	22.5	98.6	(18 ft) 217	49.5	216.7			
102	23.3	101.9	220	50.3	220.0			
105	24.0	105.1	223	51.0	223.2			
(9 ft) 109	24.8	108.4	(19 ft) 227	51.8	226.5			
112	25.5	111.7	230	52.5	229.8			
115	26.3	115.0	233	53.3	233.1			
(10 ft) 118	27.0	118.3	237	54.0	236.4			
122	27.8	121.5	(20 ft) 240	54.8	239.7			

Note: all values are rounded to the nearest 0.1 inch

Endcap (No Connector) -NPF

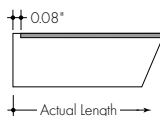

End Connector -IME

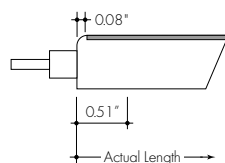

Back Connector -IMB

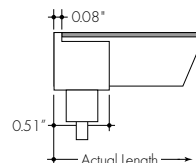

Side Connector -IMSA and -IMSB

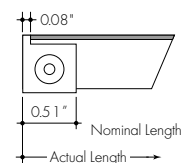

60SO | Power Consumption Per Fixture Length

Based on operation with PDCU series of power supplies. Use Acutal Length for Order Code Entry
 Tolerance for Actual Lengths less than 6 ft is +/- 0.2", Actual Lengths between 6 ft and 16 ft is +/- 0.3", and Actual Lengths greater than 16 ft is +/- 0.6"

Nominal Length (in)	W	Actual Length (in)	Nominal Length (in)	W	Actual Length (in)	Nominal Length (in)	W	Actual Length (in)	Nominal Length (in)	W	Actual Length (in)	Nominal Length (in)	W	Actual Length (in)
7	0.8	7.2	58	6.6	57.8	(8ft) 109	12.4	108.4	159	18.2	159.0	210	24.0	209.6
8	1.0	8.6	59	6.8	59.2	110	12.6	109.8	161	18.3	160.4	211	24.1	211.0
10	1.1	10.0	(5ft) 60	6.9	60.6	111	12.7	111.2	162	18.5	161.8	212	24.3	212.4
11	1.3	11.4	62	7.1	62.0	113	12.9	112.6	163	18.7	163.2	214	24.4	213.8
(1ft) 13	1.5	12.8	63	7.2	63.4	114	13.0	114.0	165	18.8	164.6	215	24.6	215.2
14	1.6	14.2	65	7.4	64.8	116	13.2	115.4	166	19.0	166.0	(18ft) 217	24.8	216.6
16	1.8	15.6	66	7.6	66.2	117	13.4	116.8	(14ft) 168	19.1	167.4	218	24.9	218.0
17	1.9	17.0	68	7.7	67.6	118	13.5	118.2	169	19.3	168.8	220	25.1	219.4
19	2.1	18.4	69	7.9	69.0	(10ft) 120	13.7	119.6	170	19.5	170.2	221	25.2	220.8
20	2.3	19.8	71	8.1	70.4	121	13.8	121.0	172	19.6	171.6	222	25.4	222.2
21	2.4	21.2	(6ft) 72	8.2	71.8	123	14.0	122.4	173	19.8	173.0	224	25.6	223.6
23	2.6	22.6	73	8.4	73.2	124	14.2	123.8	175	19.9	174.4	225	25.7	225.0
(2ft) 24	2.8	24.1	75	8.5	74.7	125	14.3	125.3	176	20.1	175.8	227	25.9	226.4
25	2.9	25.5	76	8.7	76.1	127	14.5	126.7	177	20.3	177.3	(19ft) 228	26.1	227.9
26	3.1	26.9	78	8.9	77.5	128	14.6	128.1	179	20.4	178.7	229	26.2	229.3
28	3.2	28.3	79	9.0	78.9	130	14.8	129.5	(15ft) 180	20.6	180.1	231	26.4	230.7
30	3.4	29.7	80	9.2	80.3	131	15.0	130.9	182	20.7	181.5	232	26.5	232.1
31	3.6	31.1	82	9.3	81.7	(11ft) 132	15.1	132.3	183	20.9	182.9	234	26.7	233.5
32	3.7	32.5	83	9.5	83.1	134	15.3	133.7	184	21.1	184.3	235	26.9	234.9
34	3.9	33.9	(7ft) 85	9.7	84.5	135	15.4	135.1	186	21.2	185.7	236	27.0	236.3
35	4.0	35.3	86	9.8	85.9	137	15.6	136.5	187	21.4	187.1	238	27.2	237.7
(3ft) 37	4.2	36.7	87	10.0	87.3	138	15.8	137.9	189	21.6	188.5	239	27.3	239.1
38	4.4	38.1	89	10.1	88.7	139	15.9	139.3	190	21.7	189.9	(20ft) 241	27.5	240.5
39	4.5	39.5	90	10.3	90.1	141	16.1	140.7	191	21.9	191.3	242	27.7	241.9
41	4.7	40.9	92	10.5	91.5	142	16.2	142.1	(16ft) 193	22.0	192.7	243	27.8	243.3
42	4.8	42.3	93	10.6	92.9	(12ft) 144	16.4	143.5	194	22.2	194.1	245	28.0	244.7
44	5.0	43.7	94	10.8	94.3	145	16.6	144.9	196	22.4	195.5	246	28.1	246.1
45	5.2	45.1	(8ft) 96	10.9	95.7	146	16.7	146.3	197	22.5	196.9	248	28.3	247.5
46	5.3	46.5	97	11.1	97.1	148	16.9	147.7	198	22.7	198.3	249	28.5	248.9
(4ft) 48	5.5	47.9	99	11.3	98.5	149	17.1	149.1	200	22.8	199.7	251	28.6	250.3
49	5.6	49.4	100	11.4	100.0	151	17.2	150.5	201	23.0	201.1	(21ft) 252	28.8	251.7
51	5.8	50.8	102	11.6	101.4	152	17.4	152.0	203	23.2	202.6	253	28.9	253.2
52	6.0	52.2	103	11.7	102.8	153	17.5	153.4	(17ft) 204	23.3	204.0	255	29.1	254.6
53	6.1	53.6	104	11.9	104.2	155	17.7	154.8	205	23.5	205.4	256	29.3	256.0
55	6.3	55.0	106	12.1	105.6	(13ft) 156	17.9	156.2	207	23.6	206.8			
56	6.4	56.4	107	12.2	107.0	158	18.0	157.6	208	23.8	208.2			

Note: all values are rounded to the nearest 0.1 inch

Endcap (No Connector) -NPF

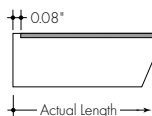

End Connector -IME

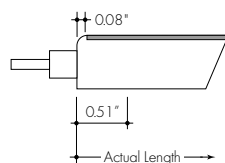

Back Connector -IMB

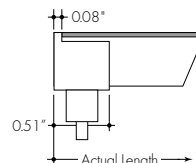

Side Connector -IMSA and -IMSB

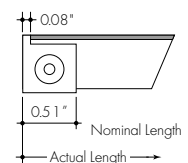

60SO | Power Consumption Per Fixture Length cont.

Based on operation with PDCU series of power supplies. Use Acutal Length for Order Code Entry
 Tolerance for Actual Lengths less than 6 ft is +/- 0.2", Actual Lengths between 6 ft and 16 ft is +/- 0.3", and Actual Lengths greater than 16 ft is +/- 0.6"

Nominal Length (in)	W	Actual Length (in)	Nominal Length (in)	W	Actual Length (in)	Nominal Length (in)	W	Actual Length (in)
258	29.4	257.4	308	35.2	307.9	359	41.0	358.5
259	29.6	258.8	310	35.4	309.3	(30ft) 360	41.2	359.9
260	29.7	260.2	311	35.5	310.7	361	41.3	361.3
262	29.9	261.6	(26ft) 312	35.7	312.1	363	41.5	362.7
263	30.1	263.0	314	35.9	313.5	364	41.6	364.1
(22ft) 265	30.2	264.4	315	36.0	314.9	366	41.8	365.5
266	30.4	265.8	317	36.2	316.3	367	42.0	366.9
267	30.5	267.2	318	36.3	317.7	368	42.1	368.3
269	30.7	268.6	319	36.5	319.1	370	42.3	369.7
270	30.9	270.0	321	36.7	320.5	371	42.4	371.1
272	31.0	271.4	322	36.8	321.9	(31ft) 373	42.6	372.5
273	31.2	272.8	(27ft) 324	37.0	323.3	374	42.8	373.9
274	31.4	274.2	325	37.1	324.8	376	42.9	375.4
(23ft) 276	31.5	275.6	326	37.3	326.2	377	43.1	376.8
277	31.7	277.0	328	37.5	327.6	378	43.2	378.2
279	31.8	278.5	329	37.6	329.0	380	43.4	379.6
280	32.0	279.9	331	37.8	330.4	381	43.6	381.0
281	32.2	281.3	332	37.9	331.8	383	43.7	382.4
283	32.3	282.7	333	38.1	333.2	(32ft) 384	43.9	383.8
284	32.5	284.1	335	38.3	334.6	385	44.0	385.2
286	32.6	285.5	(28ft) 336	38.4	336.0	387	44.2	386.6
287	32.8	286.9	338	38.6	337.4	388	44.4	388.0
(24ft) 288	33.0	288.3	339	38.7	338.8	390	44.5	389.4
290	33.1	289.7	340	38.9	340.2	391	44.7	390.8
291	33.3	291.1	342	39.1	341.6	392	44.9	392.2
293	33.4	292.5	343	39.2	343.0	(33ft) 394	45.0	393.6
294	33.6	293.9	344	39.4	344.4			
296	33.8	295.3	346	39.5	345.8			
297	33.9	296.6	(29ft) 348	39.7	347.2			
298	34.1	298.0	349	39.9	348.6			
(25ft) 300	34.2	299.5	350	40.0	350.1			
301	34.4	300.9	352	40.2	351.5			
302	34.6	302.3	353	40.4	352.9			
304	34.7	303.7	355	40.5	354.3			
305	34.9	305.1	356	40.7	355.7			
307	35.0	306.5	357	40.8	357.1			

Note: all values are rounded to the nearest 0.1 inch

Endcap (No Connector) -NPF

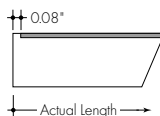

End Connector -IME

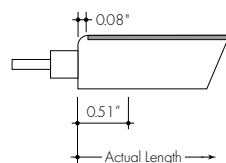

Back Connector -IMB

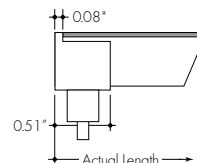

Side Connector -IMSA and -IMSB

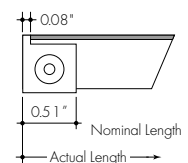

Power Supplies

See Power Supply instructions and spec sheet for wiring information. For a complete list of compatible dimmers, see Compatible Dimming Chart on the Resources page.

For use with Static White

Ordering Code Universal Dimming Power Supplies 1% 120VAC - 277VAC

MODEL	INPUT CONTROL	ENVIRONMENT	WATTAGE	OUTPUT
PS-Power Supply, 120-277VAC	UNI-0-10V Dimming, Phase Dimming	D-Dry W-Wet	30-30 Watts 60-60 Watts 96-96 Watts 3x96-3x96 Watts	24-24 VDC

Compatibility: View a complete list of compatible dimmers on product page [\(Link\)](#)

0-10V - 1% dimming
MLV/ELV/TRIAC - 1% dimming, consult dimming compatibility chart

MODELS	PS-UNI-W-30W	PS-UNI-W-60W	PS-UNI-W-96W	PS-UNI-W-3X96W
Length	6.50"	7.40"	8.66"	11.85"
Width	3.73"	3.73"	3.73"	4.32"
Depth	1.61"	1.61"	1.61"	1.81"

MODELS	PS-UNI-D-30W	PS-UNI-D-60W	PS-UNI-D-96W	PS-UNI-D-3X96W
Length	8.77"	8.77"	8.11"	9.94"
Width	4.27"	4.27"	5.60"	7.61"
Depth	1.83"	1.83"	1.83"	2.02"

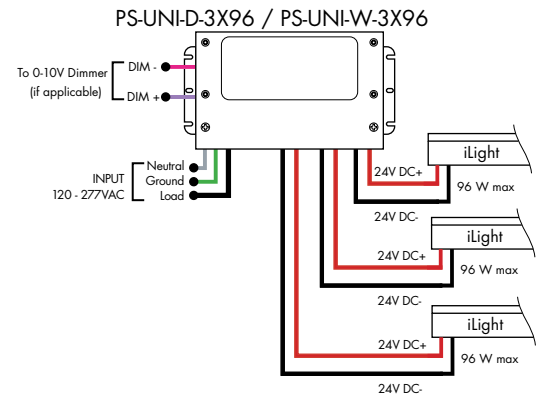
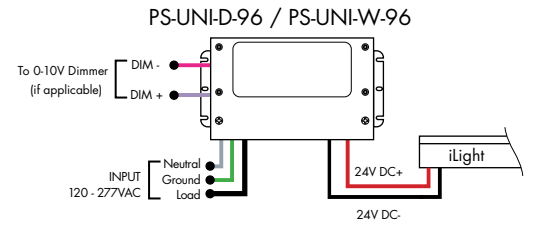

For use with Static White

0-10V Dimming Power Supplies 0.1% 120VAC - 277VAC

MODEL	POWER	OUTPUT	INPUT CONTROL	ENVIRONMENT
PS-Power Supply, 120-277VAC	96-96 Watts 3x96-3x96 Watts	24-24 VDC	010V-LIN-0-10V Dimming (0.1%), Linear 010V-LOG-0-10V Dimming (0.1%), Logarithmic	D-Dry

MODELS	96W	3X96
Length	14.40"	15.00"
Width	5.20"	6.62"
Depth	2.60"	4.45"

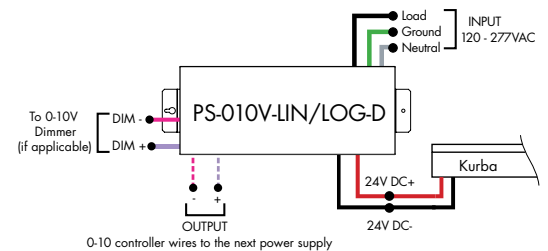
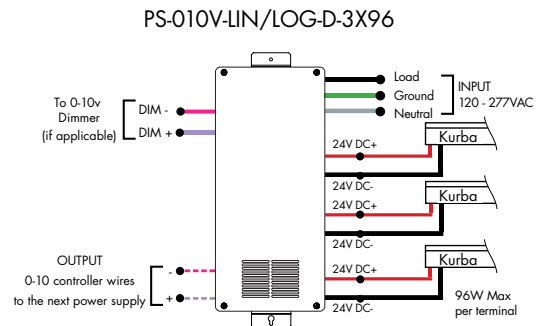

Power Supplies

See Power Supply instructions and spec sheet for wiring information. For a complete list of compatible dimmers, see Compatible Dimming Chart on the Resources page.

For use with Static White

Athena 0-10V LED Driver

MODEL	INPUT CONTROL	ENVIRONMENT	WATTAGE	OUTPUT	FEATURE
PS-Power Supply, 120-277VAC	010V-LIN-0-10V Dimming (0.1%), Linear 010V-LOG-0-10V Dimming (0.1%), Logarithmic	D-Dry	96-96 Watts	24-24 VDC	AWN-R-Athena

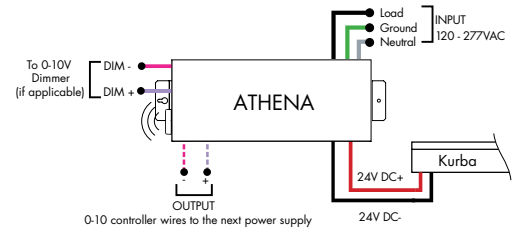

MODELS	96W
Length	14.40"
Width	5.20"
Depth	2.60"

For use with Static White

Ordering Code Phase Dimming Power Supply 1% 120VAC - 277VAC

MODEL	INPUT CONTROL	ENVIRONMENT	WATTAGE	OUTPUT	OUTPUT CONTROL
PS-Power Supply, 120-277VAC	PH-Phase Dimming (Triac, ELV, MLV)	D-Dry	96-96 Watts	24-24 VDC	DC-Direct Current

MLV/ELV/TRIAC - 1% dimming, consult dimming compatibility chart ([link](#))

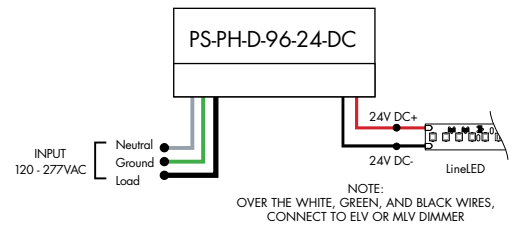

MODELS	96W
Length	8.25"
Width	4.10"
Depth	1.56"

For use with Static White

DALI Dimming Power Supplies 0.1% 120VAC - 277VAC

MODEL	INPUT CONTROL	ENVIRONMENT	WATTAGE	OUTPUT
PS-Power Supply, 120-277VAC	DALI-DALI (0.1%)	D-Dry	96-96 Watts 3x96-3x96 Watts	24-24 VDC

Model	96W	3X96
Length	14.40"	15.00"
Width	5.20"	6.62"
Depth	2.60"	4.56"

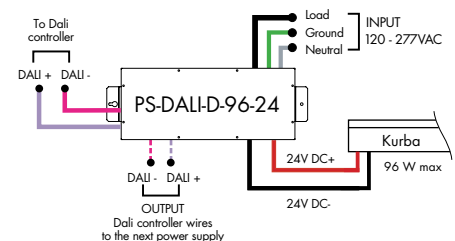
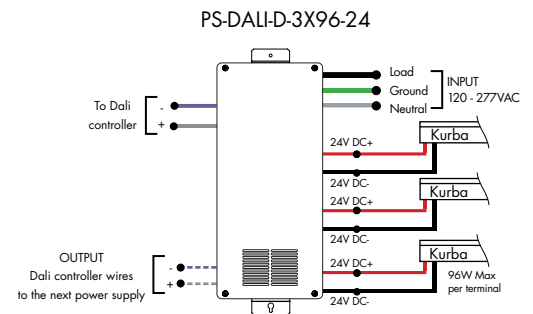

Power Supplies

See Power Supply instructions and spec sheet for wiring information. For a complete list of compatible dimmers, see Compatible Dimming Chart on the Resources page.

For use with Static White

Athena 0-10V LED Driver

MODEL	INPUT CONTROL	ENVIRONMENT	WATTAGE	OUTPUT	FEATURE
PS-Power Supply, 120-277VAC	010V-0-10V Dimming (1%)	D-Dry	96-96 Watts	24-24 VDC	ENL-0-10V Enlightened

Model	96W
Length	14.40"
Width	5.20"
Depth	2.60"

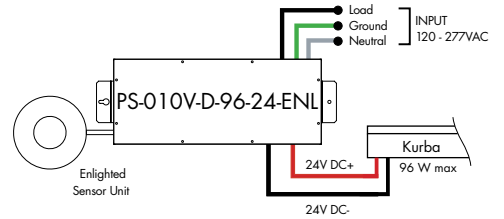

For use with Static White

Requires Zonal Control

DMX Dimming Power Supplies 0.1% 120VAC - 277VAC

MODEL	INPUT CONTROL	ENVIRONMENT	WATTAGE	OUTPUT
PS-Power Supply, 120-277VAC	DMX-DMX (0.1%)	D-Dry	96-96 Watts 3x96-3x96 Watts	24-24 VDC

MODELS	96W	3X96
Length	14.40"	15.00"
Width	5.20"	6.62"
Depth	2.60"	4.56"

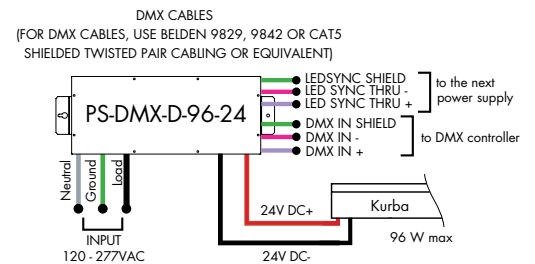
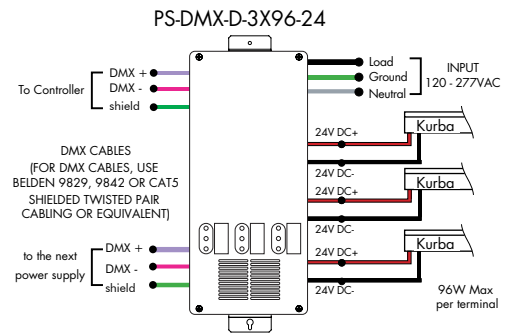

For use with Static White

DMX Dimming Power Supplies 0.1% 120VAC - 277VAC

MODEL	INPUT CONTROL	ENVIRONMENT	WATTAGE	OUTPUT
PS-Power Supply, 120-277VAC	ND-Non Dimming	D-Dry	96-96 Watts	24-24 VDC

MODELS	96W
Length	14.40"
Width	5.20"
Depth	2.60"

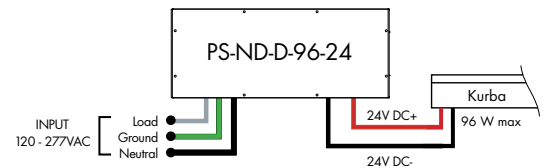

Power Supplies

See Power Supply instructions and spec sheet for wiring information. For a complete list of compatible dimmers, see Compatible Dimming Chart on the Resources page.

For use with Static White

In-Ground Power Supplies

MODEL	INPUT CONTROL	ENVIRONMENT	WATTAGE	OUTPUT
PS120-Power Supply, 120VAC PS240-Power Supply, 240VAC PS277-Power Supply, 277VAC	ELV-ELV Dimming (1%)	IG-In Ground	2X96-2X96 Watts	24-24 VDC

MODELS 2X96W

Length	8.40"
Width	8.30"
Depth	8.10"

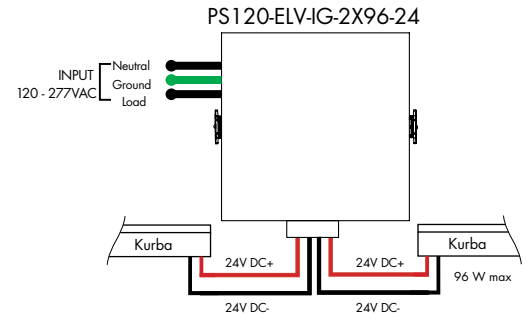

Luminii is a Lutron OEM Advantage Partner

Lutron Power Supplies 1%

MODEL

L3DA4U1UKL-CV240

HiLume™ 1% EcoSystem Voltage LED driver
40W max

MODELS L3DA4U1UKL-CV240

Length	4.98"
Width	4.00"
Depth	2.62"

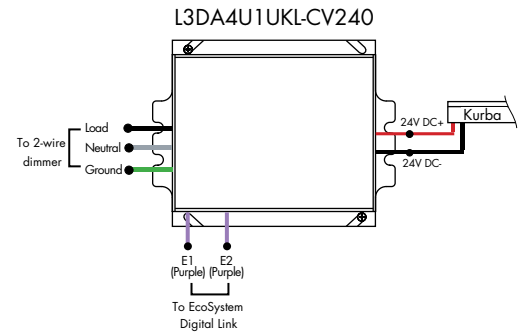

Luminii is a Lutron OEM Advantage Partner

Lutron Power Supplies 0.1%

MODEL

L3D0-96W24V-U

HiLume™ 0.1% EcoSystem Voltage LED Driver with Soft-On, Fade-to-Black™
96W max

MODELS L3D0

Length	10.50"
Width	5.50"
Depth	2.00"

