

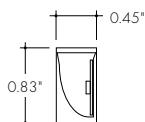

Kurma Medium Horizontal Dynamic Color

Field Bendable 24V System



Features

Kurma Medium is a dot free direct view, narrow profile, energy efficient and flexible LED strip suitable for outdoor wet locations capable of horizontal/side bends with a 2.5" bending radius. The silicone material offers excellent heat, weather, UV, and solvent resistance and has a special coating to repel dust and dirt accumulation.

Output Options

- 2-Wire Warm Dim gradually warms the color temperature as you dim down the brightness.
- Tunable White allows individual control of CCT and output
- RGB options offer balanced output across the color gamut and a true white with RGBW
- Smart Pixel offerings allow for infinite color combinations with cascading and chasing effects

Average Life (L70)

50,000 hours

Approvals

24VDC Class 2 wet listed, IP68

Warranty

3 years



Declare: **RoHS** **DIM**



Finish Options (see page 2 for additional information)

Base White

Premium Black Red Green Blue

Technical Information

Bending Direction	Horizontal				
Output	WD44SO	TW44SO	RGB18SO	RGBW18SO	SPI17SO
Light Output at 3000K	120 lm/ft	114 lm/ft	59 lm/ft	119 lm/ft	113 lm/ft
Average Power Consumption at 4'	3.66 W/ft	3.66 W/ft	3.66 W/ft	4.57 W/ft	4.57 W/ft
Efficacy	33 lm/W	31 lm/W	16 lm/W	26 lm/W	25 lm/W
Ordering Increment	3.28"	3.28"	3.94"	3.94"	4.92"
Maximum Run Length (In Series)	26'	26'	26'	19'	19'
Operating Temperature Range	-40°F to 131°F	-40°F to 131°F	-40°F to 131°F	-40°F to 113°F	-40°F to 113°F
Control/Dimming Protocol	Phase & 0-10V	0-10V, DMX	DMX	DMX	SPI Protocol UCS 2904

Constraints

Horizontal Bend Direction

Bend LED in these positions only to avoid damage

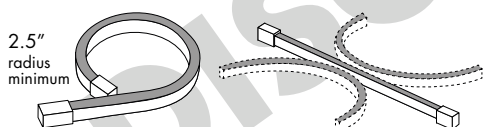

Illuminated surface shown in gray

Horizontal Prohibited Bends

Twisting or bending LED in these positions will cause damage

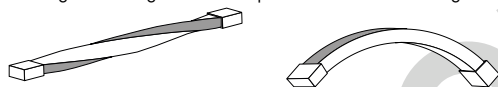

Illuminated surface shown in gray

Do not make sharp bends near the endcap

Ordering Code

MODEL	RATING	BEND DIRECTION	LENGTH	OUTPUT ¹	CCT ^{2,3}	LENS ⁴	MOUNTING	FINISH ⁵	FEED POSITION LEFT	FEED POSITION RIGHT
KBM - Kurba Medium	W - Wet	HB - Horizontal Bending	SEE PCC CHART ON PAGES 5 - 9	WD44SO - Warm Dim, Standard Output	18K30K - 1800K-3000K	SF - Silicone Frosted BL - Black Lens ⁴	NA - See Page 4 for orderable mounting accessories	WH - White BK - Black RED - Red GRN - Green BLU - Blue	INJECTION MOLD	INJECTION MOLD
				TW44SO - Tunable White, Standard Output	22K57K - 2200K-5700K 26K42K - 2600K-4200K ²					
				RGB18SO - RGB, Standard Output	RGB - Red, Green, Blue					
				RGBW18SO - RGBW, Standard Output SPI17SO - Smart Pixel Control, Standard Output	RGB26K - RGB 2600K ³ RGB27K - RGB 2700K RGB30K - RGB 3000K RGB40K - RGB 4000K					

Feeds come with 118" wire leads

1 - Title 24 IAB compliance achievable, contact factory for specific requests
2 - TW44SO-26K42K option is only available with BL Lens Option

3 - RGBW18SO-RGB26K and SPI17SO-RGB26K option is only available with BL Lens Option
4 - BL - Black Lens can only be used with BK - Black Finish

5 - Red, Green, and Blue finishes have an MOG of 350ft
6 - NPF-NPF for Feed Position 1&2 is not a valid configuration option



Powerfeeds and Connectors

Power Feed Position Options and Orientation

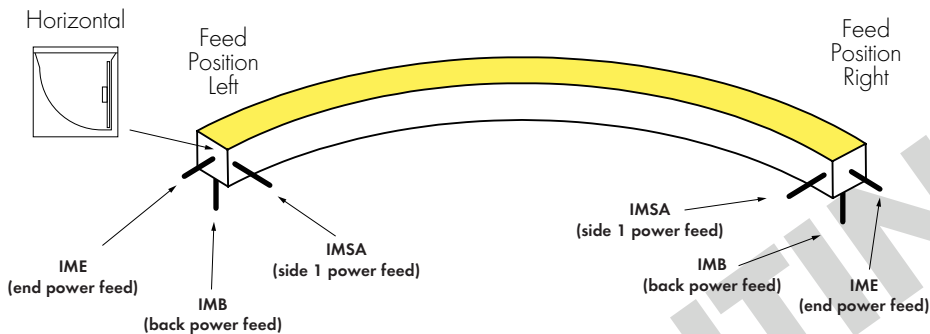

Horizontal Bend Direction

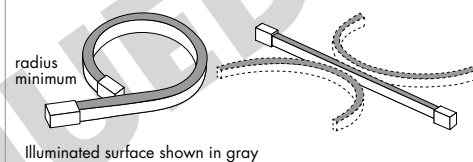

Horizontal Prohibited Bends

Twisting or bending LED in these positions will cause damage

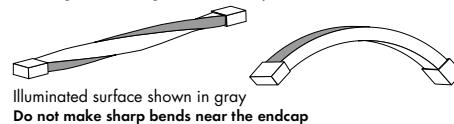

NOTE: IMSB - Side 2 Feed not available with HB - Horizontal Bending

Linking and Extension Cable Options

END CONNECTOR

Injection-molded End Connector
-IME

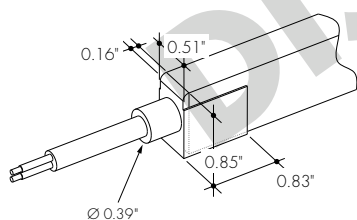

BACK CONNECTOR

Injection-molded Back Connector
-IMB

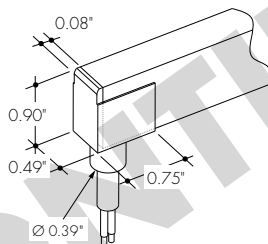

SIDE CONNECTOR

Injection-molded Side Connector
-IMSA

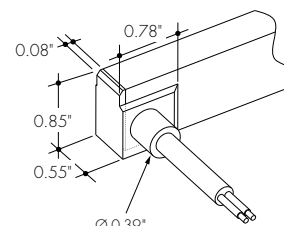

ENDCAP (NO CONNECTOR)

Injection-molded Cap (No Connector)
-NPF

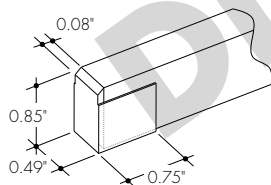

ANTI-WICKING FERRULE

Included on every power feed wire

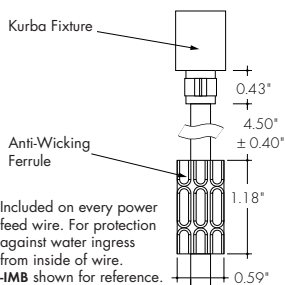

POWER FEED OPTIONS

WH/RED/GRN/BLU

BK

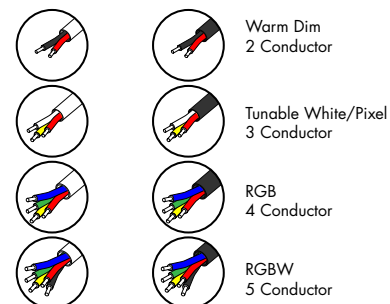



Kurba Medium Horizontal Dynamic Color

Field Bendable 24V System



Product Dimensions

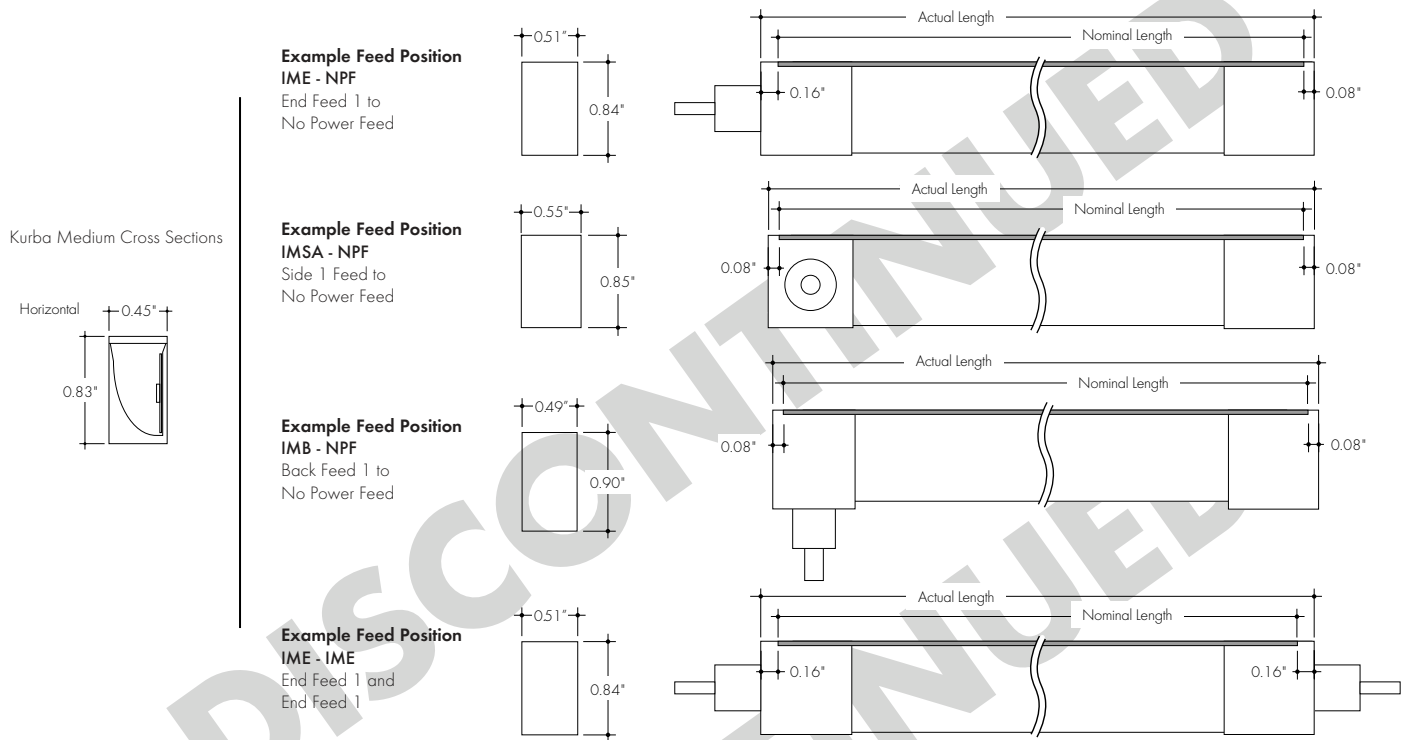

Finish Options

- A wide variety of finish options allowing complete customization of style and aesthetic.
- Red, Green, and Blue finishes have an minimum order quantity of 350ft

White
Base

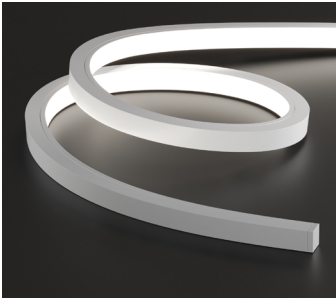

Kurba's base finish is a crisp white which brings a timeless, clean aesthetic that brightens and enhances any space

Black Finish w/ Black Lens
Premium



Also available with a blackout aesthetic - the Black Lens paired with the Black Finish provides for a sleek, all black profile that keeps the strip concealed in the off-state.

Red
Premium

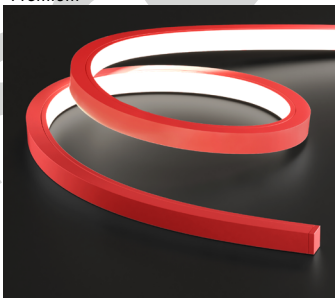

Red adds a bright and bold statement, perfect for creating a striking and dynamic ambiance with its vibrancy

Green
Premium

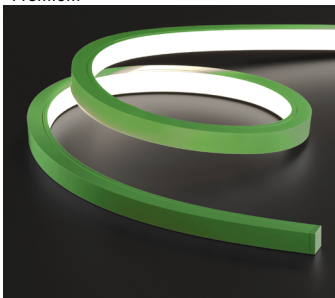

Green embraces a refreshing and natural feel, reminiscent of emerald green, add touch of tranquility and harmony to your space with this option

Blue
Premium

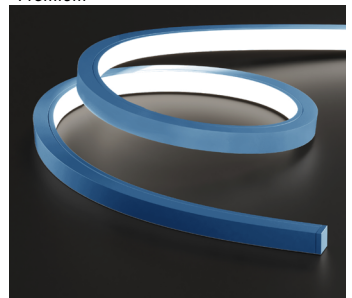

Blue evokes the serenity of the deep sea by combining vivid cobalt and azure tones.



Light Transmission and Dotting

Output Options	Lens/Accessory					
	Silicone Frosted/ White Finish	Silicone Frosted/ Red Finish	Silicone Frosted/ Green Finish	Silicone Frosted/ Blue Finish	Silicone Frosted/ Black Finish	Black Lens/ Black Finish
WD44SO	ND	ND	ND	ND	ND	ND
TW44SO	ND	ND	ND	ND	ND	ND
RGB18SO	ND	ND	ND	ND	ND	ND
RGBW18SO	ND	ND	ND	ND	ND	ND
SPI17SO	ND	ND	ND	ND	ND	ND
Transmission Percentage	100%	80%	80%	80%	80%	17%



CD SD ND
CD - Clear Dotting
SD - Slight Dotting
ND - No Dotting

Mounting Accessories & Optional Connectors

MC-KBM-SAP-SM-0.8-SA

KBM Mounting Channel, Serrated Aluminum Profile, Surface Mount, 0.8in, Silver Anodized

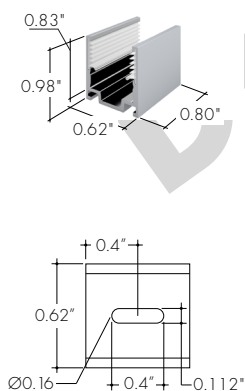

For use with light strip mounted to the ceiling.
1 recommended every 8 in.

MC-KBM-SAP-SM-78-SA

KBM Mounting Channel, Serrated Aluminum Profile, Surface Mount, 78in, Silver Anodized

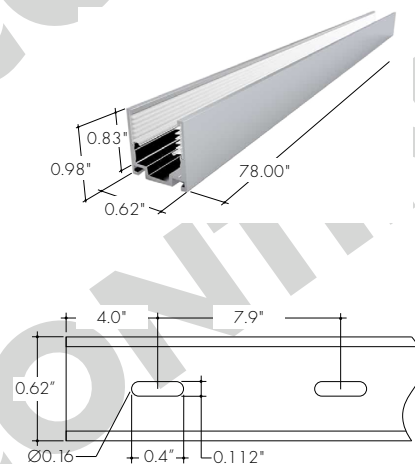

For use with light strip mounted to the ceiling.

MC-KBM-FSAP-TR-78-SA

KBM Mounting Channel, Flanged Serrated Aluminum Profile, Trimmed Recessed Mount, 78in, Silver Anodized

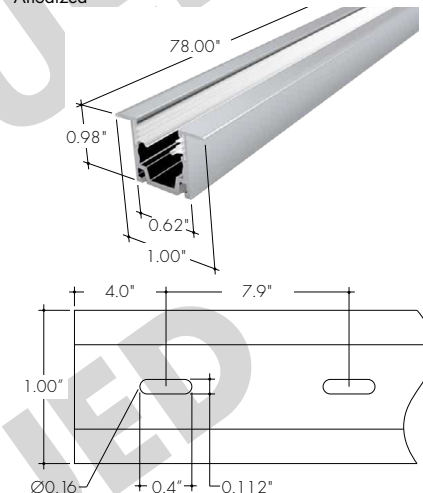

Flanged aluminum mounting channel providing grip.
For use with light strip recessed into the ceiling.

MC-KBM-BSAP-HB-SM-38-SA

KBM Mounting Channel, Bendable Serrated Aluminum Profile, Horizontal Bending, Surface Mount, 38in, Silver Anodized

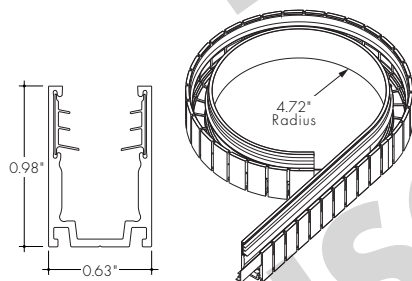

Bendable stainless steel mounting channel providing grip.
For use with light strip mounted to the ceiling.
NOTE: Compatible with **IMB** - Back Feed only

MC-KBM-RCWY-SM-78-SA

KBM Mounting Channel, Raceway, Surface Mount, 78in, Silver Anodized

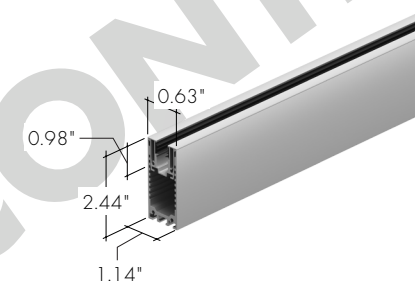

Raceway channel allows for hidden cable management and is a superb option where finidness is required.
NOTE: Compatible with **IMB** - Back Feed only

LVSP-WET

Splice box: wet rated, low voltage, gray

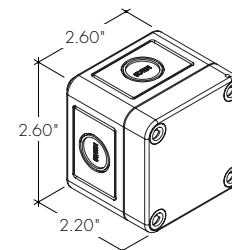

LVSP-WET-CM

Connector for splice box, low voltage for cable management, gray

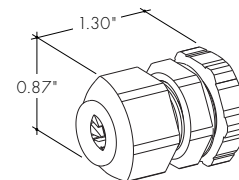



Kurba Medium Horizontal Dynamic Color | Field Bendable 24V System



WD44SO | Power Consumption Per Fixture Length

Based on operation with PDCU series of power supplies. Use Actual Length for Order Code Entry.
 Tolerance for Actual Lengths less than 6 ft is +/- 0.2", Actual Lengths between 6 ft and 16 ft is +/- 0.3", and Actual Lengths greater than 16 ft is +/- 0.6"
 A - End Connector at both ends of Kurba (0.16" + 0.16" added to overall length)
 B - End Connector at one end of Kurba and No Connector or Back Connector or Side Connector at other end of Kurba (0.16" + 0.08" added to overall length)
 C - Any combination of No Connector, Back Connector, or Side Connector on each end of Kurba (0.08" + 0.08" added to overall length)

Nominal Length (in)	Actual Length (in)				Nominal Length (in)	Actual Length (in)				Nominal Length (in)	Actual Length (in)			
	W	A	B	C		W	A	B	C		W	A	B	C
7	2.1	6.9	6.8	6.7	125	38.1	125.0	124.9	124.8	243	74.1	243.1	243.0	242.9
10	3.1	10.2	10.1	10.0	128	39.1	128.3	128.2	128.1	246	75.1	246.4	246.3	246.2
(1 ft) 14	4.1	13.4	13.4	13.3	(11 ft) 132	40.1	131.5	131.5	131.4	250	76.1	249.7	249.6	249.5
17	5.1	16.7	16.6	16.6	135	41.1	134.8	134.7	134.7	(21 ft) 253	77.1	252.9	252.9	252.8
20	6.1	20.0	19.9	19.8	138	42.1	138.1	138.0	137.9	256	78.1	256.2	256.1	256.1
(2 ft) 23	7.1	23.3	23.2	23.1	141	43.1	141.4	141.3	141.2	260	79.1	259.5	259.4	259.3
27	8.1	26.6	26.5	26.4	(12 ft) 145	44.1	144.7	144.6	144.5	(22 ft) 263	80.1	262.8	262.7	262.6
30	9.1	29.8	29.8	29.7	148	45.1	148.0	147.9	147.8	266	81.1	266.1	266.0	265.9
33	10.1	33.1	33.0	33.0	151	46.1	151.2	151.2	151.1	269	82.1	269.3	269.3	269.2
(3 ft) 36	11.1	36.4	36.3	36.2	(13 ft) 155	47.1	154.5	154.4	154.4	273	83.1	272.6	272.5	272.5
40	12.1	39.7	39.6	39.5	158	48.1	157.8	157.7	157.6	(23 ft) 276	84.1	275.9	275.8	275.7
43	13.1	43.0	42.9	42.8	161	49.1	161.1	161.0	160.9	279	85.1	279.2	279.1	279.0
46	14.1	46.2	46.2	46.1	164	50.1	164.4	164.3	164.2	283	86.1	282.5	282.4	282.3
(4 ft) 50	15.1	49.5	49.5	49.4	(14 ft) 168	51.1	167.6	167.6	167.5	286	87.1	285.7	285.7	285.6
53	16.1	52.8	52.7	52.7	171	52.1	170.9	170.8	170.8	(24 ft) 289	88.1	289.0	288.9	288.9
56	17.1	56.1	56.0	55.9	174	53.1	174.2	174.1	174.0	292	89.1	292.3	292.2	292.1
(5 ft) 59	18.1	59.4	59.3	59.2	178	54.1	177.5	177.4	177.3	296	90.1	295.6	295.5	295.4
63	19.1	62.7	62.6	62.5	(15 ft) 181	55.1	180.8	180.7	180.6	(25 ft) 299	91.1	298.9	298.8	298.7
66	20.1	65.9	65.9	65.8	184	56.1	184.0	184.0	183.9	302	92.1	302.1	302.1	302.0
69	21.1	69.2	69.1	69.1	187	57.1	187.3	187.2	187.2	306	93.1	305.4	305.3	305.3
(6 ft) 73	22.1	72.5	72.4	72.3	(16 ft) 191	58.1	190.6	190.5	190.4	309	94.1	308.7	308.6	308.5
76	23.1	75.8	75.7	75.6	194	59.1	193.9	193.8	193.7	(26 ft) 312	95.1	312.0	311.9	311.8
79	24.1	79.1	79.0	78.9	197	60.1	197.2	197.1	197.0					
(7 ft) 82	25.1	82.3	82.3	82.2	201	61.1	200.4	200.4	200.3					
86	26.1	85.6	85.5	85.5	(17 ft) 204	62.1	203.7	203.6	203.6					
89	27.1	88.9	88.8	88.7	207	63.1	207.0	206.9	206.8					
92	28.1	92.2	92.1	92.0	210	64.1	210.3	210.2	210.1					
(8 ft) 96	29.1	95.5	95.4	95.3	214	65.1	213.6	213.5	213.4					
99	30.1	98.7	98.7	98.6	(18 ft) 217	66.1	216.8	216.8	216.7					
102	31.1	102.0	101.9	101.9	220	67.1	220.1	220.0	220.0					
105	32.1	105.3	105.2	105.1	223	68.1	223.4	223.3	223.2					
(9 ft) 109	33.1	108.6	108.5	108.4	(19 ft) 227	69.1	226.7	226.6	226.5					
112	34.1	111.9	111.8	111.7	230	70.1	230.0	229.9	229.8					
115	35.1	115.1	115.1	115.0	233	71.1	233.3	233.2	233.1					
(10 ft) 119	36.1	118.4	118.3	118.3	237	72.1	236.5	236.5	236.4					
122	37.1	121.7	121.6	121.5	(20 ft) 240	73.1	239.8	239.7	239.7					

Note: all values are rounded to the nearest 0.1 inch

Endcap (No Connector) -NPF

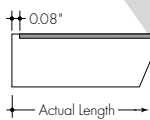

End Connector -IME

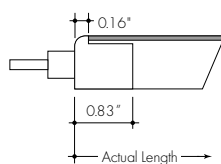

Back Connector -IMB

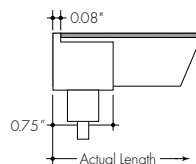

Side Connector -IMSA and -IMSB

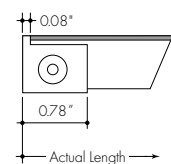



Kurba Medium Horizontal Dynamic Color | Field Bendable 24V System



TW44SO | Power Consumption Per Fixture Length

Based on operation with PDCU series of power supplies. Use Actual Length for Order Code Entry.
 Tolerance for Actual Lengths less than 6 ft is +/- 0.2", Actual Lengths between 6 ft and 16 ft is +/- 0.3", and Actual Lengths greater than 16 ft is +/- 0.6"
 A - End Connector at both ends of Kurba (0.16" + 0.16" added to overall length)
 B - End Connector at one end of Kurba and No Connector or Back Connector or Side Connector at other end of Kurba (0.16" + 0.08" added to overall length)
 C - Any combination of No Connector, Back Connector, or Side Connector on each end of Kurba (0.08" + 0.08" added to overall length)

Nominal Length (in)	Actual Length (in)				Nominal Length (in)	Actual Length (in)				Nominal Length (in)	Actual Length (in)			
	W	A	B	C		W	A	B	C		W	A	B	C
7	2.1	6.9	6.8	6.7	125	38.1	125.0	124.9	124.8	243	74.1	243.1	243.0	242.9
10	3.1	10.2	10.1	10.0	128	39.1	128.3	128.2	128.1	246	75.1	246.4	246.3	246.2
(1 ft) 14	4.1	13.4	13.4	13.3	(11 ft) 132	40.1	131.5	131.5	131.4	250	76.1	249.7	249.6	249.5
17	5.1	16.7	16.6	16.6	135	41.1	134.8	134.7	134.7	(21 ft) 253	77.1	252.9	252.9	252.8
20	6.1	20.0	19.9	19.8	138	42.1	138.1	138.0	137.9	256	78.1	256.2	256.1	256.1
(2 ft) 23	7.1	23.3	23.2	23.1	141	43.1	141.4	141.3	141.2	260	79.1	259.5	259.4	259.3
27	8.1	26.6	26.5	26.4	(12 ft) 145	44.1	144.7	144.6	144.5	(22 ft) 263	80.1	262.8	262.7	262.6
30	9.1	29.8	29.8	29.7	148	45.1	148.0	147.9	147.8	266	81.1	266.1	266.0	265.9
33	10.1	33.1	33.0	33.0	151	46.1	151.2	151.2	151.1	269	82.1	269.3	269.3	269.2
(3 ft) 36	11.1	36.4	36.3	36.2	(13 ft) 155	47.1	154.5	154.4	154.4	273	83.1	272.6	272.5	272.5
40	12.1	39.7	39.6	39.5	158	48.1	157.8	157.7	157.6	(23 ft) 276	84.1	275.9	275.8	275.7
43	13.1	43.0	42.9	42.8	161	49.1	161.1	161.0	160.9	279	85.1	279.2	279.1	279.0
46	14.1	46.2	46.2	46.1	164	50.1	164.4	164.3	164.2	282	86.1	282.5	282.4	282.3
(4 ft) 50	15.1	49.5	49.5	49.4	(14 ft) 168	51.1	167.6	167.6	167.5	286	87.1	285.7	285.7	285.6
53	16.1	52.8	52.7	52.7	171	52.1	170.9	170.8	170.8	(24 ft) 289	88.1	289.0	288.9	288.9
56	17.1	56.1	56.0	55.9	174	53.1	174.2	174.1	174.0	292	89.1	292.3	292.2	292.1
(5 ft) 59	18.1	59.4	59.3	59.2	178	54.1	177.5	177.4	177.3	296	90.1	295.6	295.5	295.4
63	19.1	62.7	62.6	62.5	(15 ft) 181	55.1	180.8	180.7	180.6	(25 ft) 299	91.1	298.9	298.8	298.7
66	20.1	65.9	65.9	65.8	184	56.1	184.0	184.0	183.9	302	92.1	302.1	302.1	302.0
69	21.1	69.2	69.1	69.1	187	57.1	187.3	187.2	187.2	305	93.1	305.4	305.3	305.3
(6 ft) 73	22.1	72.5	72.4	72.3	(16 ft) 191	58.1	190.6	190.5	190.4	309	94.1	308.7	308.6	308.5
76	23.1	75.8	75.7	75.6	194	59.1	193.9	193.8	193.7	(26 ft) 312	95.1	312.0	311.9	311.8
79	24.1	79.1	79.0	78.9	197	60.1	197.2	197.1	197.0					
(7 ft) 82	25.1	82.3	82.3	82.2	200	61.1	200.4	200.4	200.3					
86	26.1	85.6	85.5	85.5	(17 ft) 204	62.1	203.7	203.6	203.6					
89	27.1	88.9	88.8	88.7	207	63.1	207.0	206.9	206.8					
92	28.1	92.2	92.1	92.0	210	64.1	210.3	210.2	210.1					
(8 ft) 96	29.1	95.5	95.4	95.3	214	65.1	213.6	213.5	213.4					
99	30.1	98.7	98.7	98.6	(18 ft) 217	66.1	216.8	216.8	216.7					
102	31.1	102.0	101.9	101.9	220	67.1	220.1	220.0	220.0					
105	32.1	105.3	105.2	105.1	223	68.1	223.4	223.3	223.2					
(9 ft) 109	33.1	108.6	108.5	108.4	(19 ft) 227	69.1	226.7	226.6	226.5					
112	34.1	111.9	111.8	111.7	230	70.1	230.0	229.9	229.8					
115	35.1	115.1	115.1	115.0	233	71.1	233.3	233.2	233.1					
(10 ft) 118	36.1	118.4	118.3	118.3	237	72.1	236.5	236.5	236.4					
122	37.1	121.7	121.6	121.5	(20 ft) 240	73.1	239.8	239.7	239.7					

Note: all values are rounded to the nearest 0.1 inch

Endcap (No Connector) -NPF

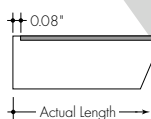

End Connector -IME

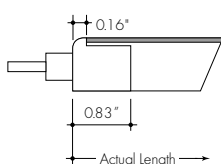

Back Connector -IMB

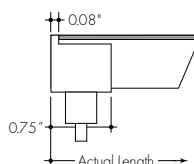

Side Connector -IMSA and -IMSB

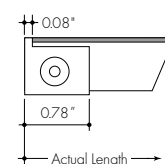



RGB18SO | Power Consumption Per Fixture Length

Based on operation with PDCU series of power supplies. Use Actual Length for Order Code Entry.
 Tolerance for Actual Lengths less than 6 ft is +/- 0.2", Actual Lengths between 6 ft and 16 ft is +/- 0.3", and Actual Lengths greater than 16 ft is +/- 0.6"
 A - End Connector at both ends of Kurba (0.16" + 0.16" added to overall length)
 B - End Connector at one end of Kurba and No Connector or Back Connector or Side Connector at other end of Kurba (0.16" + 0.08" added to overall length)
 C - Any combination of No Connector, Back Connector, or Side Connector on each end of Kurba (0.08" + 0.08" added to overall length)

Nominal Length (in)	Actual Length (in)				Nominal Length (in)	Actual Length (in)				Nominal Length (in)	Actual Length (in)			
	W	A	B	C		W	A	B	C		W	A	B	C
8	2.5	8.2	8.1	8.0	150	45.7	149.9	149.8	149.8	292	88.9	291.7	291.6	291.5
(1 ft) 12	3.7	12.1	12.1	12.0	(13 ft) 154	46.9	153.9	153.8	153.7	296	90.1	295.6	295.5	295.4
16	4.9	16.1	16.0	15.9	158	48.1	157.8	157.7	157.6	(25 ft) 300	91.3	299.5	299.5	299.4
20	6.1	20.0	19.9	19.8	162	49.3	161.7	161.7	161.6	304	92.5	303.5	303.4	303.3
(2 ft) 24	7.3	23.9	23.9	23.8	166	50.5	165.7	165.6	165.5	308	93.7	307.4	307.3	307.2
28	8.5	27.9	27.8	27.7	(14 ft) 170	51.7	169.6	169.5	169.5	(26 ft) 312	94.9	311.3	311.3	311.2
32	9.7	31.8	31.7	31.7	174	52.9	173.5	173.5	173.4					
(3 ft) 36	10.9	35.8	35.7	35.6	178	54.1	177.5	177.4	177.3					
40	12.1	39.7	39.6	39.5	(15 ft) 182	55.3	181.4	181.3	181.3					
44	13.3	43.6	43.5	43.5	186	56.5	185.4	185.3	185.2					
(4 ft) 48	14.5	47.6	47.5	47.4	190	57.7	189.3	189.2	189.1					
52	15.7	51.5	51.4	51.3	(16 ft) 193	58.9	193.2	193.2	193.1					
56	16.9	55.4	55.4	55.3	197	60.1	197.2	197.1	197.0					
(5 ft) 60	18.1	59.4	59.3	59.2	201	61.3	201.1	201.0	200.9					
63	19.3	63.3	63.2	63.2	(17 ft) 205	62.5	205.0	205.0	204.9					
67	20.5	67.2	67.2	67.1	209	63.7	209.0	208.9	208.8					
(6 ft) 71	21.7	71.2	71.1	71.0	213	64.9	212.9	212.8	212.8					
75	22.9	75.1	75.0	75.0	(18 ft) 217	66.1	216.9	216.8	216.7					
79	24.1	79.1	79.0	78.9	221	67.3	220.8	220.7	220.6					
(7 ft) 83	25.3	83.0	82.9	82.8	225	68.5	224.7	224.6	224.6					
87	26.5	86.9	86.9	86.8	(19 ft) 229	69.7	228.7	228.6	228.5					
91	27.7	90.9	90.8	90.7	233	70.9	232.6	232.5	232.4					
(8 ft) 95	28.9	94.8	94.7	94.6	237	72.1	236.5	236.5	236.4					
99	30.1	98.7	98.7	98.6	(20 ft) 241	73.3	240.5	240.4	240.3					
103	31.3	102.7	102.6	102.5	245	74.5	244.4	244.3	244.3					
(9 ft) 107	32.5	106.6	106.5	106.5	249	75.7	248.4	248.3	248.2					
111	33.7	110.6	110.5	110.4	(21 ft) 253	76.9	252.3	252.2	252.1					
115	34.9	114.5	114.4	114.3	257	78.1	256.2	256.1	256.1					
(10 ft) 119	36.1	118.4	118.4	118.3	260	79.3	260.2	260.1	260.0					
123	37.3	122.4	122.3	122.2	(22 ft) 264	80.5	264.1	264.0	263.9					
126	38.5	126.3	126.2	126.1	268	81.7	268.0	268.0	267.9					
(11 ft) 130	39.7	130.2	130.2	130.1	272	82.9	272.0	271.9	271.8					
134	40.9	134.2	134.1	134.0	(23 ft) 276	84.1	275.9	275.8	275.8					
138	42.1	138.1	138.0	138.0	280	85.3	279.8	279.8	279.7					
(12 ft) 143	43.3	142.1	142.0	141.9	284	86.5	283.8	283.7	283.6					
146	44.5	146.0	145.9	145.8	(24 ft) 288	87.7	287.7	287.6	287.6					

Note: all values are rounded to the nearest 0.1 inch

Endcap (No Connector) -NPF

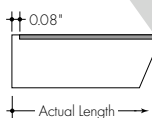

End Connector -IME

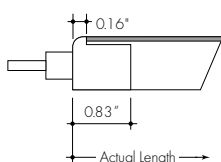

Back Connector -IMB

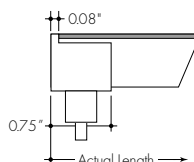

Side Connector -IMSA and -IMSB

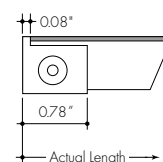



RGBW18SO | Power Consumption Per Fixture Length

Based on operation with PDCU series of power supplies. Use Actual Length for Order Code Entry.
 Tolerance for Actual Lengths less than 6 ft is +/- 0.2", Actual Lengths between 6 ft and 16 ft is +/- 0.3", and Actual Lengths greater than 16 ft is +/- 0.6"
 A - End Connector at both ends of Kurba (0.16" + 0.16" added to overall length)
 B - End Connector at one end of Kurba and No Connector or Back Connector or Side Connector at other end of Kurba (0.16" + 0.08" added to overall length)
 C - Any combination of No Connector, Back Connector, or Side Connector on each end of Kurba (0.08" + 0.08" added to overall length)

Nominal Length (in)	Actual Length (in)				Nominal Length (in)	Actual Length (in)			
	W	A	B	C		W	A	B	C
8	3.1	8.2	8.1	8.0	150	57.1	149.9	149.8	149.8
(1 ft) 12	4.6	12.1	12.1	12.0	(13 ft) 154	58.6	153.9	153.8	153.7
16	6.1	16.1	16.0	15.9	158	60.1	157.8	157.7	157.6
20	7.6	20.0	19.9	19.8	162	61.6	161.7	161.7	161.6
(2 ft) 24	9.1	23.9	23.9	23.8	166	63.1	165.7	165.6	165.5
28	10.6	27.9	27.8	27.7	(14 ft) 170	64.6	169.6	169.5	169.5
32	12.1	31.8	31.7	31.7	174	66.1	173.5	173.5	173.4
(3 ft) 36	13.6	35.8	35.7	35.6	178	67.6	177.5	177.4	177.3
40	15.1	39.7	39.6	39.5	(15 ft) 182	69.1	181.4	181.3	181.3
44	16.6	43.6	43.5	43.5	186	70.6	185.4	185.3	185.2
(4 ft) 48	18.1	47.6	47.5	47.4	190	72.1	189.3	189.2	189.1
52	19.6	51.5	51.4	51.3	(16 ft) 193	73.6	193.2	193.2	193.1
56	21.1	55.4	55.4	55.3	197	75.1	197.2	197.1	197.0
(5 ft) 60	22.6	59.4	59.3	59.2	201	76.6	201.1	201.0	200.9
63	24.1	63.3	63.2	63.2	(17 ft) 205	78.1	205.0	205.0	204.9
67	25.6	67.2	67.2	67.1	209	79.6	209.0	208.9	208.8
(6 ft) 71	27.1	71.2	71.1	71.0	213	81.1	212.9	212.8	212.8
75	28.6	75.1	75.0	75.0	(18 ft) 217	82.6	216.9	216.8	216.7
79	30.1	79.1	79.0	78.9	221	84.1	220.8	220.7	220.6
(7 ft) 83	31.6	83.0	82.9	82.8	225	85.6	224.7	224.6	224.6
87	33.1	86.9	86.9	86.8	(19 ft) 229	87.1	228.7	228.6	228.5
91	34.6	90.9	90.8	90.7					
(8 ft) 95	36.1	94.8	94.7	94.6					
99	37.6	98.7	98.7	98.6					
103	39.1	102.7	102.6	102.5					
(9 ft) 107	40.6	106.6	106.5	106.5					
111	42.1	110.6	110.5	110.4					
115	43.6	114.5	114.4	114.3					
(10 ft) 119	45.1	118.4	118.4	118.3					
123	46.6	122.4	122.3	122.2					
126	48.1	126.3	126.2	126.1					
(11 ft) 130	49.6	130.2	130.2	130.1					
134	51.1	134.2	134.1	134.0					
138	52.6	138.1	138.0	138.0					
(12 ft) 143	54.1	142.1	142.0	141.9					
146	55.6	146.0	145.9	145.8					

Note: all values are rounded to the nearest 0.1 inch

Endcap (No Connector) -NPF

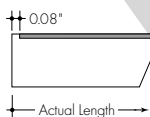

End Connector -IME

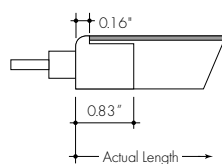

Back Connector -IMB

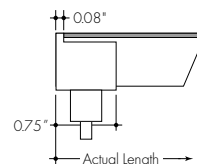

Side Connector -IMSA and -IMSB

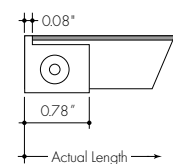



SPI17SO | Power Consumption Per Fixture Length

Based on operation with PDCU series of power supplies. Use Acutal Length for Order Code Entry.
 Tolerance for Actual Lengths less than 6 ft is +/- 0.2", Actual Lengths between 6 ft and 16 ft is +/- 0.3", and Actual Lengths greater than 16 ft is +/- 0.6"
 A - End Connector at both ends of Kurba (0.16" + 0.16" added to overall length)
 B - End Connector at one end of Kurba and No Connector or Back Connector or Side Connector at other end of Kurba (0.16" + 0.08" added to overall length)
 C - Any combination of No Connector, Back Connector, or Side Connector on each end of Kurba (0.08" + 0.08" added to overall length)

Nominal Length (in)	Actual Length (in)				Nominal Length (in)	Actual Length (in)			
	W	A	B	C		W	A	B	C
(1 ft) 10	3.9	10.2	10.1	10.0	187	71.4	187.3	187.2	187.2
15	5.7	15.1	15.0	14.9	(16 ft) 192	73.3	192.2	192.2	192.1
20	7.6	20.0	19.9	19.8	197	75.1	197.2	197.1	197.0
(2 ft) 25	9.5	24.9	24.8	24.8	(17 ft) 202	77.0	202.1	202.0	201.9
30	11.4	29.8	29.8	29.7	207	78.9	207.0	206.9	206.9
(3 ft) 35	13.3	34.8	34.7	34.6	212	80.8	211.9	211.9	211.8
40	15.1	39.7	39.6	39.5	(18 ft) 217	82.6	216.9	216.8	216.7
45	17.0	44.6	44.5	44.5	222	84.5	221.8	221.7	221.6
(4 ft) 50	18.9	49.5	49.5	49.4	(19 ft) 227	86.4	226.7	226.6	226.5
55	20.8	54.5	54.4	54.3					
(5 ft) 59	22.6	59.4	59.3	59.2					
64	24.5	64.3	64.2	64.1					
69	26.4	69.2	69.1	69.1					
(6 ft) 74	28.3	74.1	74.1	74.0					
79	30.1	79.1	79.0	78.9					
(7 ft) 84	32.0	84.0	83.9	83.8					
89	33.9	88.9	88.8	88.7					
(8 ft) 94	35.8	93.8	93.7	93.7					
99	37.6	98.7	98.7	98.6					
104	39.5	103.7	103.6	103.5					
(9 ft) 109	41.4	108.6	108.5	108.4					
114	43.3	113.5	113.4	113.3					
(10 ft) 119	45.1	118.4	118.4	118.3					
123	47.0	123.4	123.3	123.2					
128	48.9	128.3	128.2	128.1					
(11 ft) 133	50.8	133.2	133.1	133.0					
138	52.6	138.1	138.0	138.0					
(12 ft) 143	54.5	143.0	143.0	142.9					
148	56.4	148.0	147.9	147.8					
153	58.3	152.9	152.8	152.7					
(13 ft) 158	60.1	157.8	157.7	157.6					
163	62.0	162.7	162.6	162.6					
(14 ft) 168	63.9	167.6	167.6	167.5					
173	65.8	172.6	172.5	172.4					
(15 ft) 178	67.6	177.5	177.4	177.3					
182	69.5	182.4	182.3	182.2					

Note: all values are rounded to the nearest 0.1 inch

Endcap (No Connector) -NPF

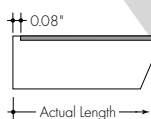

End Connector -IME

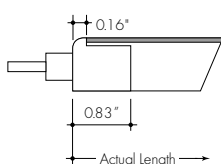

Back Connector -IMB

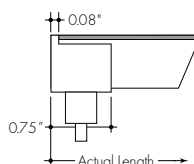

Side Connector -IMSA and -IMSB

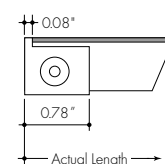



Power Supplies

See fixture and power supply instructions & spec sheet for wiring information. Dimming possible in select models - view Luminii website for list of compatible dimmers.

For use with Warm Dim

Phase Dimming Power Supply 1% 120VAC - 277VAC

MODEL	INPUT CONTROL	ENVIRONMENT	WATTAGE	OUTPUT	OUTPUT CONTROL
PS-Power Supply, 120-277VAC	PH-Phase Dimming (Triac, ELV, MLV)	D-Dry	96-96 Watts	24-24 VDC	DC-Direct Current

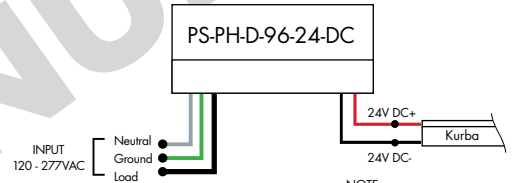

MLV/ELV/TRIAC - 1% dimming, consult dimming compatibility chart [\(Link\)](#)

MODELS	96W
Length	8.25"
Width	4.10"
Depth	1.56"

For use with Tunable White

DALI2 Dimming Power Supplies 0.1% 120VAC - 277VAC

MODEL	INPUT CONTROL	ENVIRONMENT	WATTAGE	OUTPUT	OUTPUT CONTROL
PS-Power Supply, 120-277VAC	DALI-DT8-DALI DT8 Tunable White (0.1%)	D-Dry	96-96 Watts	24-24 VDC	PWM-Pulse Width Modulation

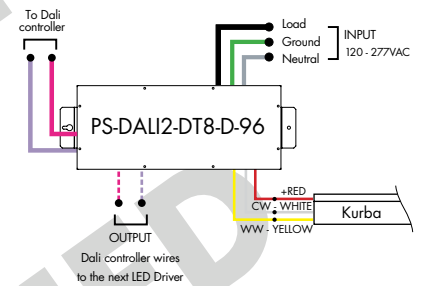

MODELS	96W
Length	14.40"
Width	5.20"
Depth	2.60"

Athena DALI2-DT8 LED Driver

MODEL	INPUT CONTROL	ENVIRONMENT	WATTAGE	OUTPUT	FEATURE
PS-Power Supply, 120-277VAC	DALI-DT8-DALI DT8 Tunable White	D-Dry	96-96 Watts	24-24 VDC	AWNR-Athena

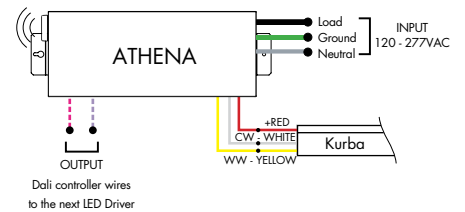

MODELS	96W
Length	14.40"
Width	5.20"
Depth	2.60"



Power Supplies

See fixture and power supply instructions & spec sheet for wiring information. Dimming possible in select models - view Luminii website for list of compatible dimmers.

For use with Tunable White

VintageDim® 0 - 10V Dimming Power Supplies 0.1% 120VAC - 277VAC

MODEL	INPUT CONTROL	ENVIRONMENT	WATTAGE	OUTPUT
PS - Power Supply, 120-277VAC	010V-WD - 0-10V Dimming (0.1%), Standard Warm Dim Curve (with Tunable White LED) 010V-TW - 0-10V Dimming (0.1%), Two Channel Control, Brightness and CCT1-CCT2 Ratio 010V-2CH - 0-10V Dimming (0.1%), Two Channel Control, LED1 Brightness and LED2 Brightness 010V-WDX - 0-10V Dimming (0.1%), Customizable Warm Dim Curve (with Tunable White LED) 010V-2CHX - 0-10V Dimming (0.1%), Two Channel Control, Customizable Brightness and CCT1-CCT2 Ratio	D-Dry	96-96 Watts 3X96 - 3x96 Watts ¹	24-24 VDC

1 - 3x96 is only available with input control options 010V-WD and 010V-TW
2 - Athena only available on 96 watts option

MODELS	96W	3X96
Length	14.40"	15.00"
Width	5.20"	6.62"
Depth	2.60"	4.56"

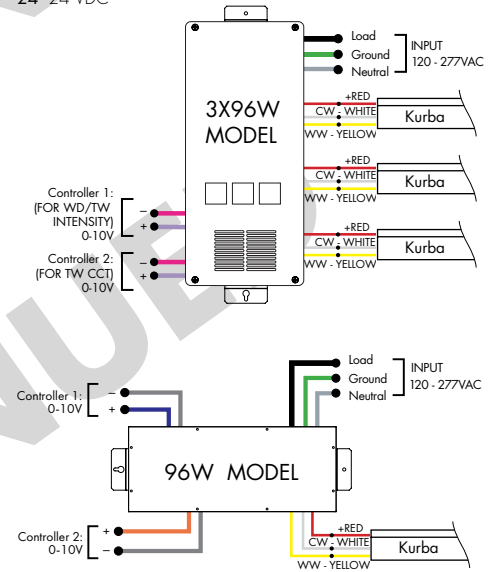

Athena 0-10V Warm Dim LED Driver

MODEL	INPUT CONTROL	ENVIRONMENT	WATTAGE	OUTPUT	FEATURE
PS - Power Supply, 120-277VAC	010V-WD - 0-10V Dimming, Standard Warm Dim Curve (with Dynamic White LED)	D-Dry	96-96 W	24-24 VDC	AWNR-Athena

MODELS	96W
Length	14.40"
Width	5.20"
Depth	2.60"

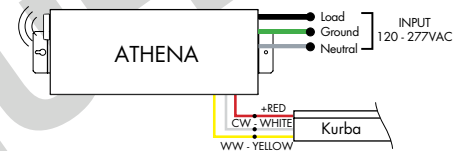

Athena 0-10V Two Channel LED Driver

MODEL	INPUT CONTROL	ENVIRONMENT	WATTAGE	OUTPUT	FEATURE
PS - Power Supply, 120-277VAC	010V-2CH - 0-10V Dimming Two Channel Control, LED1 Brightness and LED2 Brightness	D-Dry	96-96 W	24-24 VDC	AWNR-Athena

MODELS	96W
Length	14.40"
Width	5.20"
Depth	2.60"

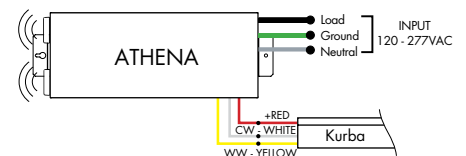



Power Supplies

See fixture and power supply instructions & spec sheet for wiring information. Dimming possible in select models - view Luminii website for list of compatible dimmers.

For use with RGB/RGBW, Tunable White

Requires Controller

DMX Dimming Power Supplies 0.1% 120VAC - 277VAC

MODEL	INPUT CONTROL	ENVIRONMENT	WATTAGE	OUTPUT
PS-Power Supply, 120-277VAC	DMX-DMX (0.1%)	D-Dry	96-96 Watts 3X96-3X96 Watts	24-24 VDC

MODELS	96W	3X96
Length	14.40"	15.00"
Width	5.20"	6.62"
Depth	2.60"	4.56"

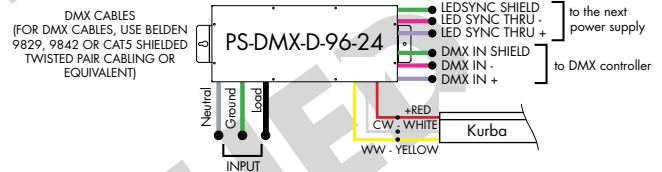
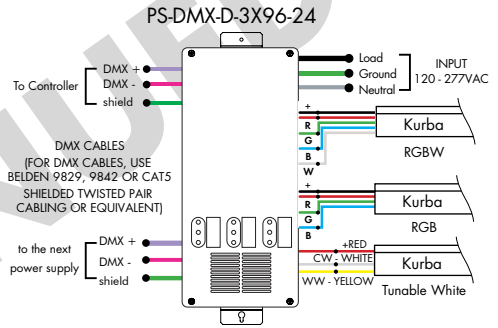

For use with RGB/RGBW/Pixel

Non-Dimming Power Supply 120VAC - 277VAC

MODEL	INPUT CONTROL	ENVIRONMENT	WATTAGE	OUTPUT
PS - PSV Series	ND - Non Dimming	D - Dry	96 - 96 Watts	24 - 24 VDC

Requires a controller and a decoder to work properly

MODELS	96W
Length	14.40"
Width	5.20"
Depth	2.60"

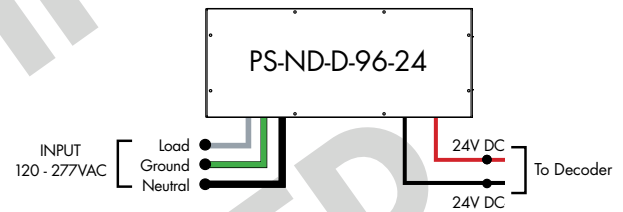

For use with RGB/RGBW

Universal Dimming Power Supplies 1% 120VAC - 277VAC

MODEL	INPUT CONTROL	ENVIRONMENT	WATTAGE	OUTPUT
PS-Power Supply, 120-277VAC	UNI-0-10V Dimming, Phase Dimming	D-Dry W-Wet	30-30 Watts 60-60 Watts 96-96 Watts 3x96-3x96 Watts	24-24 VDC

Compatibility: View a complete list of compatible dimmers on product page [Link](#) 0-10V - 1% dimming MLV/ELV/TRIAC - 1% dimming, consult dimming compatibility chart

MODELS	PS-UNI-W-30W	PS-UNI-W-60W	PS-UNI-W-96W	PS-UNI-W-3X96W
Length	6.50"	7.40"	8.66"	11.85"
Width	3.73"	3.73"	3.73"	4.32"
Depth	1.61"	1.61"	1.61"	1.81"

MODELS	PS-UNI-D-30W	PS-UNI-D-60W	PS-UNI-D-96W	PS-UNI-D-3X96W
Length	8.77"	8.77"	8.11"	9.94"
Width	4.27"	4.27"	5.60"	7.61"
Depth	1.83"	1.83"	1.83"	2.02"

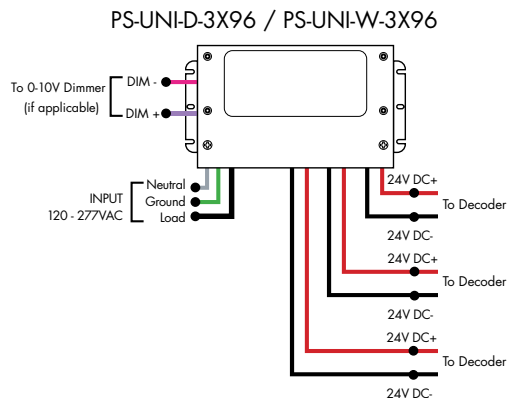
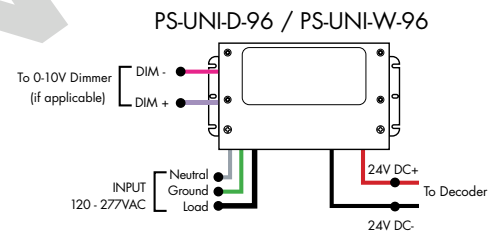



Controllers and Decoders

For use with Tunable White Power Supplies



ORDERING CODE

MODEL

DTW-MC

DTW-MC - Tunable White controller

Tunable White wall-mount controller controls lighting fixtures, wireless control of TW lighting fixture. Fits in any standard US switch box. Includes all the outputs in the back of the controller.

Features

- Switch & dimming control function, control range > 20M.
- Smooth transition between light levels.
- Separately operate dimming and color temperature functions.
- Able to control 1 zone with endless receivers. Each receiver can maximally be controlled by 8 remotes.
- Power, temperature color and dimming functions operated by push button after receivers are connected.

Operating Voltage

3V DC battery

Color Parameters

- Brightness
- Saturation
- Fading



ORDERING CODE

MODEL

TW-DMX

TW-DMX - DMX controller

Tunable White DMX wall-mount controller is a fully touch sensitive controller designed in accordance with standard protocol DMX512. Offers fast and accurate color temperature adjustment and brightness dimming of natural white, warm white and cold white. Designed with a touch color wheel, the DMX512 controller can adjust color temperature and brightness for all white LEDs smoothly and accurately. The DMX controller can control 1 zone with endless decoders.

Features

- 1 zone
- 6 color scenes
- DMX Control
- Touch Sensitive Glass Surface
- Dimming and Speed Control
- Memory Function
- Easily Fits Standard US Switch Boxes

Operating Voltage

12 - 24V DC

Color Parameters

- Brightness
- Saturation
- Primary colors
- Fading
- Color changing speed



ORDERING CODE

MODEL

SLD-DIMTW

SLD-DIMTW - Tunable white LED dimming module

The SLD DimTW is a constant voltage warm dimming LED dimming module. The unique dimming module accepts 0-10V control and mimics a smooth, incandescent dimming curve.

Features

- Flicker free 0-100% dimming
- High efficiency up to 97%
- High precision dimming ratio:>1:1000
- Fully isolated plastic housing
- Comply with EN55015 and FCC part 15 without additional input filter and capacitors
- compact size, high reliability
- 3 years warranty

Operating Voltage

8-48 VDC



Controllers and Decoders

For use with Tunable White, RGB/RGBW Power Supplies



Translates controller DMX512 programs for RGB and white LED strips.

Unique DMX address for the decoder can be set easily and displayed by the numeric display on the case. Changing and resetting the DMX address requires manual input.

Use power repeater to expand output.

Operating Voltage

12-36 VDC

Operating Temperature Range

from -4°F to +122°F in case

Power Capacity

up to 96W at 24V

ORDERING CODE

MODEL

DDMX-RGBW

DDMX-RGBW - DMX decoder



The RGBW receiver is easily paired with controller by the click of a button. Receiver can be reset to factory settings at any time.

Each receiver can store one static RGB color, one color sequence, and one brightness setting for the white LED strip. Receivers assigned to the same scene within the same zone will have the same LED static color and color sequence.

Operating Voltage

12-36 VDC

Operating Temperature Range

from -4°F to +122°F in case

Power Capacity

up to 96W at 24V

ORDERING CODE

MODEL

RGBW-RC-R

RGBW-RC-R - RGBW receiver



Extends identical signal when connected in series to an RGBW LED control system. The RGBW signal repeater works with Luminii RGB and RGBW controllers, receivers, and decoders.

RGBW signal can be extended indefinitely when adequate power supply (not included) is connected to the system.

Operating Voltage

12-36 VDC

Operating Temperature Range

from -4°F to +122°F in case

Power Capacity

up to 96W at 24V

ORDERING CODE

MODEL

RGBW-SR

RGBW-SR - RGBW signal repeater



Controllers and Decoders

For use with RGB/RGBW Power Supplies



ORDERING CODE

MODEL

RGBW-MC3

RGBW-MC3 - 4-zone RGBW controller

Easy to operate wireless interface suitable for static or color changing scenes. Control 4 different color zones separately or at the same time. RGBW receiver (RGBWV-RC-R) required for operation. Assign multiple receivers per zone to cover a large area.

Color wheel enables highly stable and sensitive color control functionality. Create your own color changing sequences with ease and flexibility.

Power

qty 3 AAA batteries

Scenes

up to 4 unique zones

Signal

Wireless (RF)

Energy Saving

Deactivates after 10 seconds of inactivity

Color Parameters

- Brightness
- Saturation
- Primary colors
- Speed of color changing sequence
- Fading

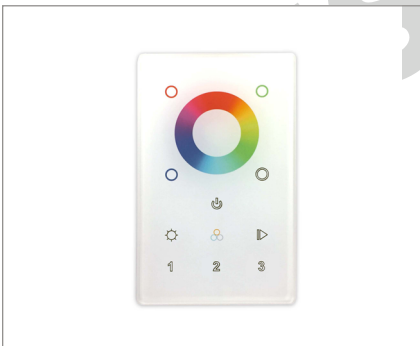

ORDERING CODE

MODEL

ZONES

COLOR

DMX-DMX Controller	3Z-Three Zone 1Z-One Zone	RGBW-Red,Green, Blue,& White
-----------------------	------------------------------	---------------------------------

DMX /Wireless RGB-W wall-mount controller controls DMX lighting fixtures, wireless control of RGB-W lighting fixture or use both simultaneously. Fits in any standard US switch box. Includes all the outputs in the back of the controller.

Control brightness levels with a single touch, personalize and memorize 3 different scenes, and even create 3 variations of white.

Features

- 2 in 1 in-Wall Controller: DMX Control or Wireless RGB-W
- 65,000 Color Options, Dimming and Speed Control
- Memory Function
- 50 Foot Wireless Range
- Easily Fits Standard US Switch Boxes
- Touch Sensitive Glass Surface
- Includes 10 Built in Programs, or Create and Play Your Own

Operating Voltage

12 - 24V DC

Color Parameters

- Brightness
- Saturation
- Primary colors
- Fading
- Color changing speed

For use with Tunable White, RGB/RGBW, Pixel Power Supplies

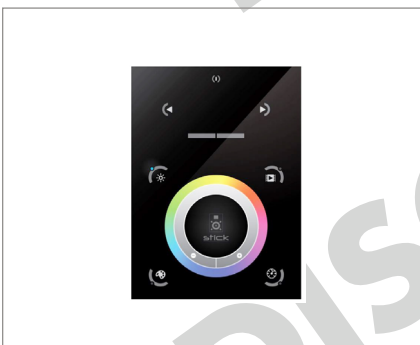

ORDERING CODE

MODEL

TSDMX-E

TSDMX-E - Touchscreen DMX controller

Programmable advanced DMX512 lighting controller featuring a touch-screen interface. Operates as stand alone controller or integrated with most architectural lighting control systems. Can controller endless DMX512 enabled devices.

Mounts to standard single or dual gang wall box with the included power supply inside the junction box. Terminal block design for power and data connections.

Features

- Sleek glass design which sits 0.43" from the wall
- Graphical color display to show selected environment
- Color/dimmer/speed palette
- Color temperature mixing
- Touch sensitive buttons. No mechanical parts
- Touch sensitive wheel allows for accurate color selection
- Multi-zone microSD memory
- Multi-room control with 500 scenes, 10 zones
- 1024 DMX channels. Control 340 RGB fixtures
- USB & Ethernet connectivity for programming and control

Power Supply

7 VDC (included)

Programmability

PC, Mac, Tablet, Smartphone

Output Signal

DMX512 (1024 channels)

Color Parameters

- Brightness
- Saturation
- Speed of color changing sequence
- Fading / dimming / brightness



Controllers and Decoders

For use with Pixel Power Supplies



ORDERING CODE

MODEL

SR-DMX-SPI

SR-DMX-SPI - Smart Pixel Decoder

The SR-DMX-SPI is a smart LED pixel decoder that controls RGB/RGBW pixel LED strips with SPI signal. Designed with an OLED backlit panel, the pixel controller allows for easy configuration of most settings. Four push buttons are available for control of the LED functions.

*For pixel only.

Features

- 2 in 1 in-Wall Controller: DMX Control or Wireless RGB-W
- SPI signal output for RGB/RGBW pixel light control
- DMX512 controllable and RF/WIFI remote controllable
- Capable of addressing up to 1020 RGB pixels & 765 RGBW pixels
- OLED panel allows for easy configuration

Operating Voltage

12 - 36V DC

Power capacity

up to 96W at 24V

Operating temperature range

from -4°F to +122°F in case

For use with Tunable White, RGB/RGBW Power Supplies



ORDERING CODE

MODEL

DDMX-5CH-RDM-PRO

DDMX-5CH-RDM-PRO - DMX512 Decoder

DMX512 decoder with RDM functionality features 5 PWM output channels with common anode. High PWM output frequency range allows the product to be used in HD video conferencing spaces. All DMX products to be installed per DMX512 Standard.

Power

96 Watt

Inputs

RJ45, XLR-5Pin, Terminal Block

DMX Channels

1 to 5 settable

PWM Output Resolution Ratio

8 or 16 bit

PWM Output Frequency

500Hz - 30KHz

Output Dimming Curve Gamma Value

0.1 ~ 9.9



ORDERING CODE

MODEL

RGBW-WI-R

RGBW-WI-R - WIFI generator

RGBW-WI-R creates a local network that enables any electronic device (phone, tablet, etc.) to control the RGB/W strip connected to a RGBW-RC-R receiver.

The control functions are achieved through a free application download for Android and iOS devices called REALCOLOR.

Operating Voltage

12-36 VDC

Power Supply

PI-130-24 (included)

Operating Temperature Range

from -4°F to +122°F in case