

Features

Kurba Large is a dot free direct view, highly versatile, energy efficient and flexible LED strip suitable for outdoor wet locations capable of horizontal/side bends and vertical/top bends with a 6" bending radius. The silicone material offers excellent heat, weather, UV, and solvent resistance and has a special coating to repel dust and dirt accumulation.

Output Options

- 2-Wire Warm Dim gradually warms the color temperature as you dim down the brightness
- Tunable White allows individual control of CCT and output

Average Life (L70)

50,000 hours

Approvals

24VDC Class 2 wet listed, IP68

Warranty

3 years

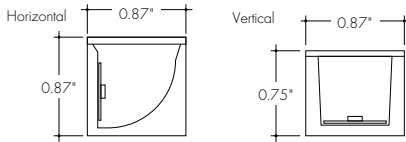

Finish Options (see page 2 for additional information)

Base White

RoHS Declare



Technical Information

Bending Direction	Horizontal		Vertical	
	TW	WD	TW	WD
Output				
Light Output at 3000K	167 lm/ft	160 lm/ft	208 lm/ft	204 lm/ft
Average Power Consumption at 4'	3.66 W/ft	3.66 W/ft	3.66 W/ft	3.66 W/ft
Efficacy	46 lm/W	44 lm/W	57 lm/W	56 lm/W
Ordering Increment	3.28"	2.46"	3.28"	2.46"
Maximum Run Length (In Series)	19'	19'	19'	19'
Operating Temperature Range	-40°F to 131°F	-40°F to 131°F	-40°F to 131°F	-40°F to 131°F
Control/Dimming Protocol	0-10V, DMX	Phase & 0-10V	0-10V, DMX	Phase & 0-10V

Constraints

Horizontal Bend Direction

Bend LED in these positions only to avoid damage

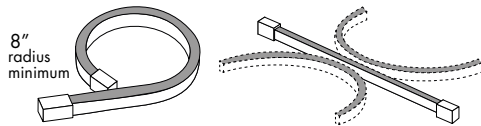

Illuminated surface shown in gray

Horizontal Prohibited Bends

Twisting or bending LED in these positions will cause damage

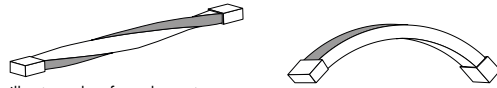

Illuminated surface shown in gray

Do not make sharp bends near the endcap

Vertical Bend Direction

Bend LED in these positions only to avoid damage

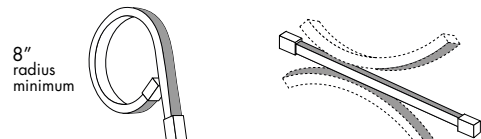

Illuminated surface shown in gray

Vertical Prohibited Bends

Twisting or bending LED in these positions will cause damage

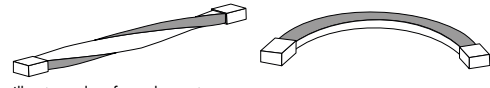

Illuminated surface shown in gray

Do not make sharp bends near the endcap

Ordering Code

MODEL	RATING	BEND DIRECTION	LENGTH	OUTPUT ¹	CCT	LENS	MOUNTING	FINISH	FEED POSITION LEFT	FEED POSITION RIGHT
KBX-Kurba Max	W-Wet	HB-Horizontal Bending VB-Vertical Bending	SEE PCC CHART ON PAGES 7 & 8	WD59SO-Warm Dim, Standard Output TW51SO-Tunable White, Standard Output	18K30K-1800K-3000K 22K57K-2200K-5700K	SF-Silicone Frosted	NA-See Page 6 for orderable mounting accessories	WH-White	INJECTION MOLD IME-End Feed 1 IMB-Back Feed 1 IMSA-Side 1 Feed IMSB-Side 2 Feed ² NPF-No Power Feed ³	INJECTION MOLD IME-End Feed 1 IMB-Back Feed 1 IMSA-Side 1 Feed IMSB-Side 2 Feed ² NPF-No Power Feed ³

Feeds come with 118" wire leads

1 - Title 24 JA8 compliance achievable, contact factory for specific requests

2 - IMSB - Side 2 Feed not available with HB - Horizontal Bending

3 - NPF-NPF for Feed Position 1&2 is not a valid configuration option

Powerfeeds and Connectors

Power Feed Position Options and Orientation

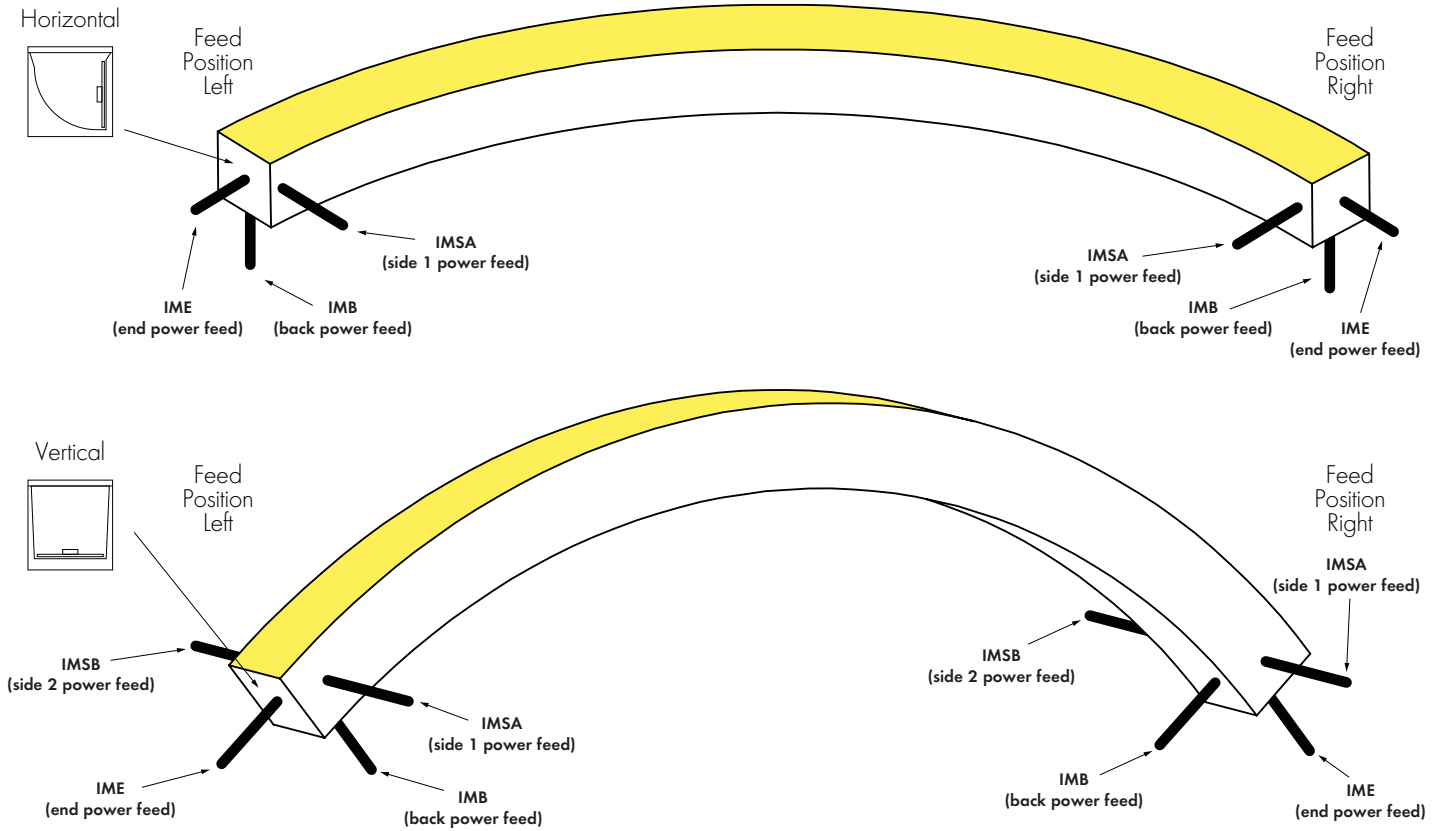

NOTE: IMSB - Side 2 Feed not available with HB - Horizontal Bending

Powerfeed Options

Horizontal Bend

END CONNECTOR

Injection-molded End Connector
-IME

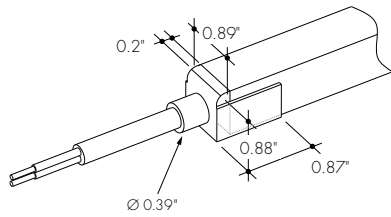

BACK CONNECTOR

Injection-molded Back Connector
-IMB

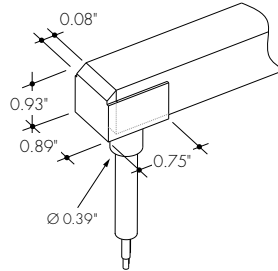

SIDE CONNECTOR

Injection-molded Side Connector
-IMSA

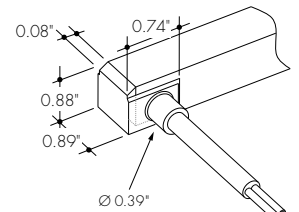

ENDCAP (NO CONNECTOR)

Injection-molded Cap (No Connector)
-NPF

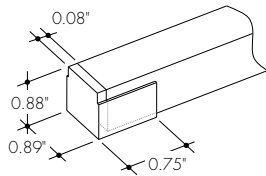

ANTI-WICKING FERRULE

Included on every power feed wire

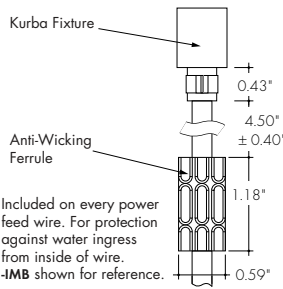

POWER FEED OPTIONS

WH

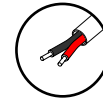

Warm Dim
2 Conductor

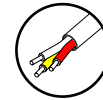

Tunable White
3 Conductor

Vertical Bend

END CONNECTOR

Injection-molded End Connector
-IME

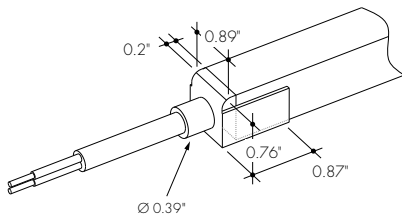

BACK CONNECTOR

Injection-molded Back Connector
-IMB

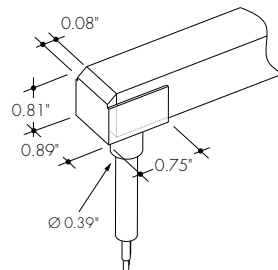

SIDE CONNECTOR

Injection-molded Side Connector
-IMSA and -IMSB

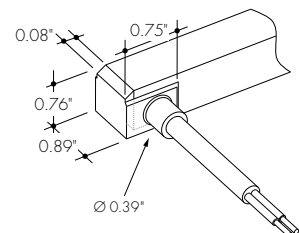

ENDCAP (NO CONNECTOR)

Injection-molded Cap (No Connector)
-NPF

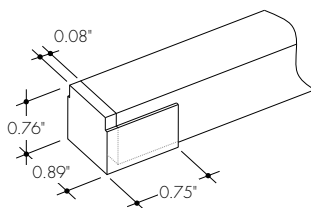

ANTI-WICKING FERRULE

Included on every power feed wire

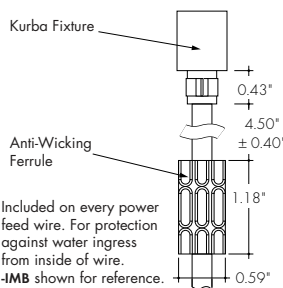

POWER FEED OPTIONS

WH



Warm Dim
2 Conductor

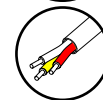

Tunable White
3 Conductor

Product Dimensions

Horizontal Bend

Kurba Max Cross Sections

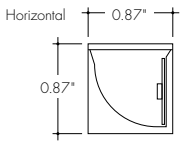

Example Feed Position
IME - NPF
End Feed 1 to
No Power Feed

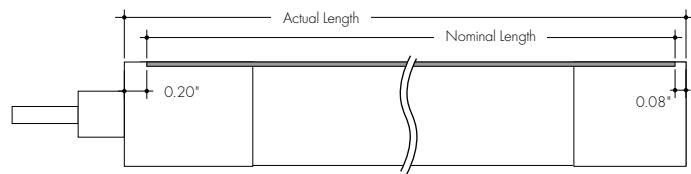
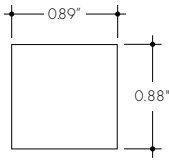

Example Feed Position
IMSA - NPF
Side 1 Feed to
No Power Feed

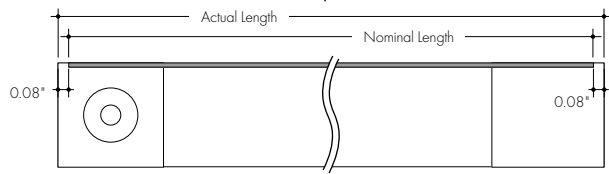
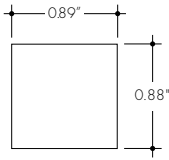

Example Feed Position
IMB - NPF
Back Feed 1 to
No Power Feed

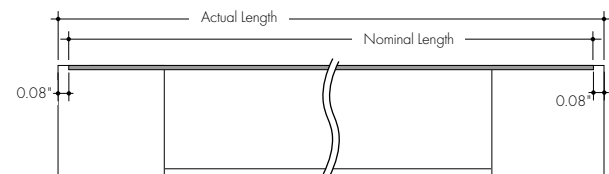
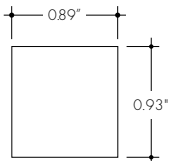

Example Feed Position
IME - IME
End Feed 1 and
End Feed 1

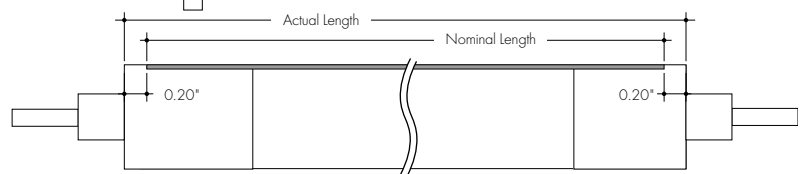
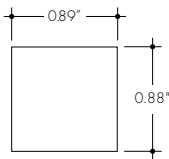

Vertical Bend

Kurba Max Cross Sections

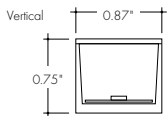

Example Feed Position
IME - NPF
End Feed 1 to
No Power Feed

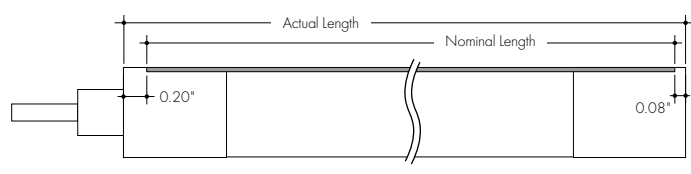
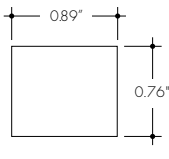

Example Feed Position
IMSA - NPF
Side 1 Feed to
No Power Feed

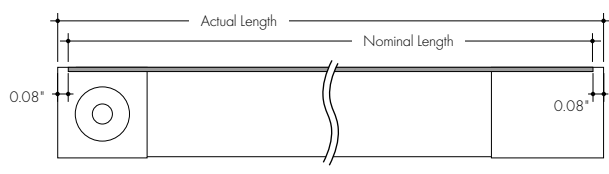
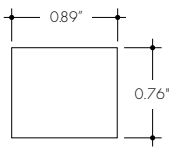

Example Feed Position
IMB - NPF
Back Feed 1 to
No Power Feed

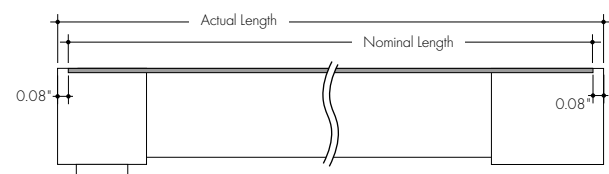
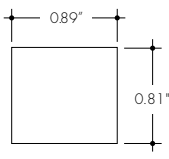

Example Feed Position
IME - IME
End Feed 1 and
End Feed 1

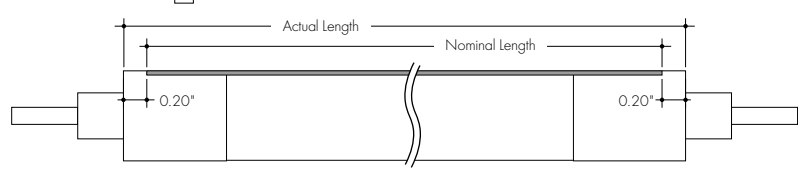
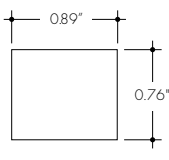

Finish Options

White
Base

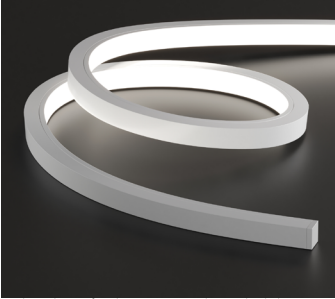

Kurba's base finish is a crisp white which brings a timeless, clean aesthetic that brightens and enhances any space

Light Transmission and Dotting

	Lens/Accessory
Output Options	Silicone Frosted/ White Finish
WD59SO	ND
TW51SO	ND
Transmission Percentage	100%



CD SD ND
CD - Clear Dotting
SD - Slight Dotting
ND - No Dotting

Mounting Accessories

MC-KBX-SAP-SM-0.8-SA

KBX Mounting Channel, Serrated Aluminum Profile, Surface Mount, 0.8in, Silver Anodized

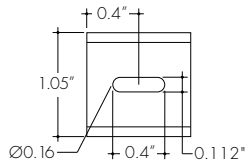
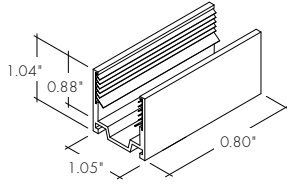

Aluminum mounting bracket providing grip. For use with light strip mounted to the ceiling. 1 recommended every 8 in.

MC-KBX-SAP-SM-78-SA

KBX Mounting Channel, Serrated Aluminum Profile, Surface Mount, 78in, Silver Anodized

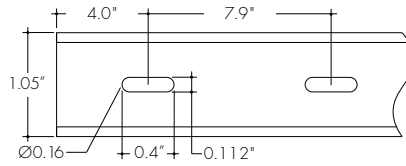
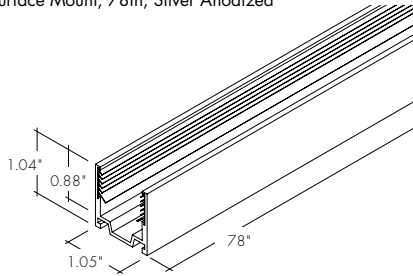

Aluminum mounting channel providing grip. For use with light strip mounted to the ceiling.

MC-KBX-FSAP-TR-78-SA

Flanged Mounting Channel with grip, 78"

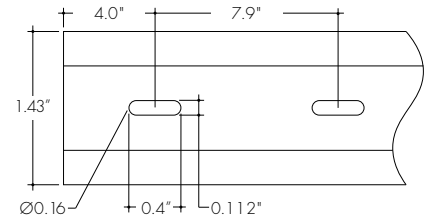
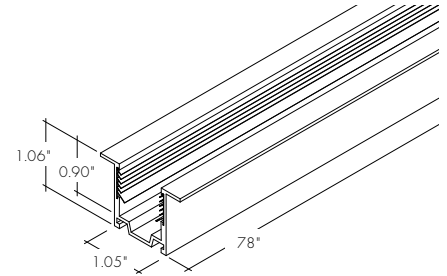

Flanged aluminum mounting channel providing grip. For use with light strip mounted to the ceiling.

MC-KBX-BSAP-HB-SM-38-SA

KBX Mounting Channel, Bendable Serrated Aluminum Profile, Horizontal Bending, Surface Mount, 38in, Silver Anodized

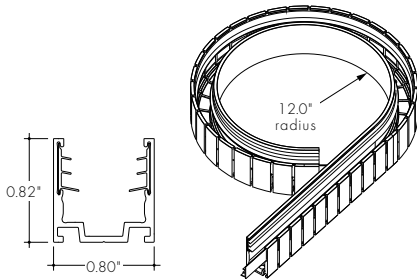

Bendable stainless steel mounting channel providing grip. For use with light strip mounted to the ceiling. **NOTE:** Compatible with HB - Horizontal Bend only

LVSP-WET

Splice box: wet rated, low voltage, gray

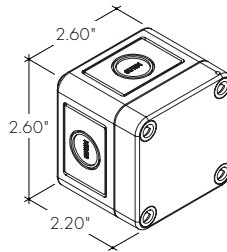

LVSP-WET-CM

Connector for splice box, low voltage for cable management, gray

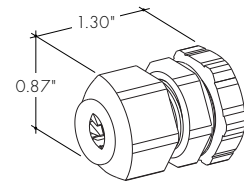

TW44SO | Power Consumption Per Fixture Length

Based on operation with PDCU series of power supplies. Use Actual Length for Order Code Entry.
 Tolerance for Actual Lengths less than 6 ft is +/- 0.2", Actual Lengths between 6 ft and 16 ft is +/- 0.3", and Actual Lengths greater than 16 ft is +/- 0.6"
 A - End Connector at both ends of Kurba (0.20" + 0.20" added to overall length)
 B - End Connector at one end of Kurba and No Connector or Back Connector or Side Connector at other end of Kurba (0.20" + 0.08" added to overall length)
 C - Any combination of No Connector, Back Connector, or Side Connector on each end of Kurba (0.08" + 0.08" added to overall length)

Nominal Length (in)	Actual Length (in)				Nominal Length (in)	Actual Length (in)			
	W	A	B	C		W	A	B	C
7	2.1	7.0	6.8	6.7	122	37.1	121.8	121.7	121.5
10	3.1	10.2	10.1	10.0	125	38.1	125.1	124.9	124.8
(1 ft) 14	4.1	13.5	13.4	13.3	128	39.1	128.3	128.2	128.1
17	5.1	16.8	16.7	16.6	(11 ft) 132	40.1	131.6	131.5	131.4
20	6.1	20.1	20.0	19.8	135	41.1	134.9	134.8	134.7
(2 ft) 23	7.1	23.4	23.2	23.1	138	42.1	138.2	138.1	137.9
27	8.1	26.6	26.5	26.4	141	43.1	141.5	141.4	141.2
30	9.1	29.9	29.8	29.7	(12 ft) 145	44.1	144.8	144.6	144.5
33	10.1	33.2	33.1	33.0	148	45.1	148.0	147.9	147.8
(3 ft) 36	11.1	36.5	36.4	36.2	151	46.1	151.3	151.2	151.1
40	12.1	39.8	39.6	39.5	(13 ft) 155	47.1	154.6	154.5	154.4
43	13.1	43.0	42.9	42.8	158	48.1	157.9	157.8	157.6
46	14.1	46.3	46.2	46.1	161	49.1	161.2	161.0	160.9
(4 ft) 50	15.1	49.6	49.5	49.4	164	50.1	164.4	164.3	164.2
53	16.1	52.9	52.8	52.7	(14 ft) 168	51.1	167.7	167.6	167.5
56	17.1	56.2	56.1	55.9	171	52.1	171.0	170.9	170.8
(5 ft) 59	18.1	59.5	59.3	59.2	174	53.1	174.3	174.2	174.0
63	19.1	62.7	62.6	62.5	178	54.1	177.6	177.4	177.3
66	20.1	66.0	65.9	65.8	(15 ft) 181	55.1	180.8	180.7	180.6
69	21.1	69.3	69.2	69.1	184	56.1	184.1	184.0	183.9
(6 ft) 73	22.1	72.6	72.5	72.3	187	57.1	187.4	187.3	187.2
76	23.1	75.9	75.7	75.6	(16 ft) 191	58.1	190.7	190.6	190.4
79	24.1	79.1	79.0	78.9	194	59.1	194.0	193.8	193.7
(7 ft) 82	25.1	82.4	82.3	82.2	197	60.1	197.2	197.1	197.0
86	26.1	85.7	85.6	85.5	200	61.1	200.5	200.4	200.3
89	27.1	89.0	88.9	88.7	(17 ft) 204	62.1	203.8	203.7	203.6
92	28.1	92.3	92.1	92.0	207	63.1	207.1	207.0	206.8
(8 ft) 96	29.1	95.5	95.4	95.3	210	64.1	210.4	210.2	210.1
99	30.1	98.8	98.7	98.6	214	65.1	213.6	213.5	213.4
102	31.1	102.1	102.0	101.9	(18 ft) 217	66.1	216.9	216.8	216.7
105	32.1	105.4	105.3	105.1	220	67.1	220.2	220.1	220.0
(9 ft) 109	33.1	108.7	108.5	108.4	223	68.1	223.5	223.4	223.2
112	34.1	111.9	111.8	111.7	(19 ft) 227	69.1	226.8	226.6	226.5
115	35.1	115.2	115.1	115.0					
(10 ft) 118	36.1	118.5	118.4	118.3					

Note: All values are rounded to the nearest 0.1 inch.

Endcap (No Connector) -NPF

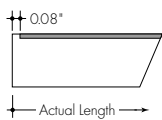

End Connector -IME

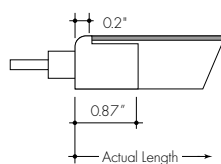

Back Connector -IMB

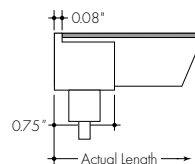

Side Connector -IMSA and -IMSB

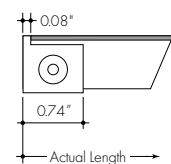

WD59SO | Power Consumption Per Fixture Length

Based on operation with PDCU series of power supplies. Use Actual Length for Order Code Entry.
 Tolerance for Actual Lengths less than 6 ft is +/- 0.2", Actual Lengths between 6 ft and 16 ft is +/- 0.3", and Actual Lengths greater than 16 ft is +/- 0.6"
 A - End Connector at both ends of Kurba (0.20" + 0.20" added to overall length)
 B - End Connector at one end of Kurba and No Connector or Back Connector or Side Connector at other end of Kurba (0.20" + 0.08" added to overall length)
 C - Any combination of No Connector, Back Connector, or Side Connector on each end of Kurba (0.08" + 0.08" added to overall length)

Nominal Length (in)	Actual Length (in)				Nominal Length (in)	Actual Length (in)				Nominal Length (in)	Actual Length (in)			
	W	A	B	C		W	A	B	C		W	A	B	C
8	2.4	7.8	7.7	7.5	(8 ft) 96	29.4	96.4	96.2	96.1	185	56.4	184.9	184.8	184.7
10	3.1	10.2	10.1	10.0	99	30.1	98.8	98.7	98.6	187	57.1	187.4	187.3	187.2
(1 ft) 13	3.9	12.7	12.6	12.5	101	30.9	101.3	101.2	101.0	190	57.9	189.9	189.7	189.6
15	4.6	15.2	15.0	14.9	104	31.6	103.7	103.6	103.5	(16 ft) 192	58.6	192.3	192.2	192.1
18	5.4	17.6	17.5	17.4	106	32.4	106.2	106.1	106.0	195	59.4	194.8	194.7	194.5
20	6.1	20.1	20.0	19.8	(9 ft) 109	33.1	108.7	108.5	108.4	197	60.1	197.3	197.1	197.0
23	6.9	22.5	22.4	22.3	111	33.9	111.1	111.0	110.9	200	60.9	199.7	199.6	199.5
(2 ft) 25	7.6	25.0	24.9	24.8	114	34.6	113.6	113.5	113.3	202	61.6	202.2	202.1	201.9
27	8.4	27.5	27.3	27.2	116	35.4	116.0	115.9	115.8	(17 ft) 205	62.4	204.6	204.5	204.4
30	9.1	29.9	29.8	29.7	119	36.1	118.5	118.4	118.3	207	63.1	207.1	207.0	206.9
32	9.9	32.4	32.3	32.1	(10 ft) 121	36.9	121.0	120.9	120.7	210	63.9	209.6	209.4	209.3
(3 ft) 35	10.6	34.8	34.7	34.6	123	37.6	123.4	123.3	123.2	212	64.6	212.0	211.9	211.8
37	11.4	37.3	37.2	37.1	126	38.4	125.9	125.8	125.7	214	65.4	214.5	214.4	214.2
40	12.1	39.8	39.7	39.5	128	39.1	128.4	128.2	128.1	(18 ft) 217	66.1	216.9	216.8	216.7
42	12.9	42.2	42.1	42.0	(11 ft) 131	39.9	130.8	130.7	130.6	219	66.9	219.4	219.3	219.2
45	13.6	44.7	44.6	44.5	133	40.6	133.3	133.2	133.0	222	67.6	221.9	221.7	221.6
(4 ft) 47	14.4	47.2	47.0	46.9	136	41.4	135.7	135.6	135.5	224	68.4	224.3	224.2	224.1
50	15.1	49.6	49.5	49.4	138	42.1	138.2	138.1	138.0	(19 ft) 227	69.1	226.8	226.7	226.5
52	15.9	52.1	52.0	51.8	141	42.9	140.7	140.5	140.4					
55	16.6	54.5	54.4	54.3	(12 ft) 143	43.6	143.1	143.0	142.9					
57	17.4	57.0	56.9	56.8	146	44.4	145.6	145.5	145.3					
(5 ft) 59	18.1	59.5	59.3	59.2	148	45.1	148.0	147.9	147.8					
62	18.9	61.9	61.8	61.7	150	45.9	150.5	150.4	150.3					
64	19.6	64.4	64.3	64.1	153	46.6	153.0	152.8	152.7					
67	20.4	66.8	66.7	66.6	(13 ft) 155	47.4	155.4	155.3	155.2					
69	21.1	69.3	69.2	69.1	158	48.1	157.9	157.8	157.6					
(6 ft) 72	21.9	71.8	71.6	71.5	160	48.9	160.3	160.2	160.1					
74	22.6	74.2	74.1	74.0	163	49.6	162.8	162.7	162.6					
77	23.4	76.7	76.6	76.4	165	50.4	165.3	165.1	165.0					
79	24.1	79.1	79.0	78.9	(14 ft) 168	51.1	167.7	167.6	167.5					
82	24.9	81.6	81.5	81.4	170	51.9	170.2	170.1	169.9					
(7 ft) 84	25.6	84.1	83.9	83.8	173	52.6	172.6	172.5	172.4					
87	26.4	86.5	86.4	86.3	175	53.4	175.1	175.0	174.9					
89	27.1	89.0	88.9	88.7	178	54.1	177.6	177.4	177.3					
91	27.9	91.4	91.3	91.2	(15 ft) 180	54.9	180.0	179.9	179.8					
94	28.6	93.9	93.8	93.7	182	55.6	182.5	182.4	182.2					

Note: All values are rounded to the nearest 0.1 inch.

Endcap (No Connector) -NPF

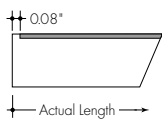

End Connector -IME

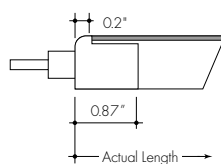

Back Connector -IMB

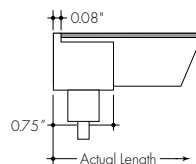

Side Connector -IMSA and -IMSB

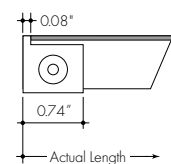

Power Supplies

See fixture and power supply instructions & spec sheet for wiring information. Dimming possible in select models - view Luminii website for list of compatible dimmers.

For use with Warm Dim

Universal Dimming Power Supplies 1% 120VAC - 277VAC

MODEL	INPUT CONTROL	ENVIRONMENT	WATTAGE	OUTPUT
PS-Power Supply, 120-277VAC	UNI-0-10V Dimming, Phase Dimming	D-Dry W-Wet	30-30 Watts 60-60 Watts 96-96 Watts 3x96-3x96 Watts	24-24 VDC

Compatibility: View a complete list of compatible dimmers on product page [\(Link\)](#) 0-10V - 1% dimming MLV/ELV/TRIAC - 1% dimming, consult dimming compatibility chart

MODELS	PS-UNI-W-30W	PS-UNI-W-60W	PS-UNI-W-96W	PS-UNI-W-3X96W
Length	6.50"	7.40"	8.66"	11.85"
Width	3.73"	3.73"	3.73"	4.32"
Depth	1.61"	1.61"	1.61"	1.81"

MODELS	PS-UNI-D-30W	PS-UNI-D-60W	PS-UNI-D-96W	PS-UNI-D-3X96W
Length	8.77"	8.77"	8.11"	9.94"
Width	4.27"	4.27"	5.60"	7.61"
Depth	1.83"	1.83"	1.83"	2.02"

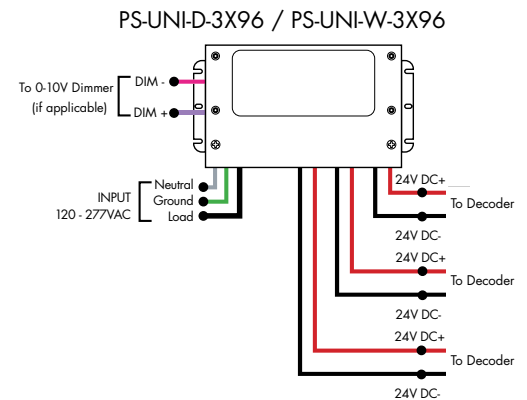
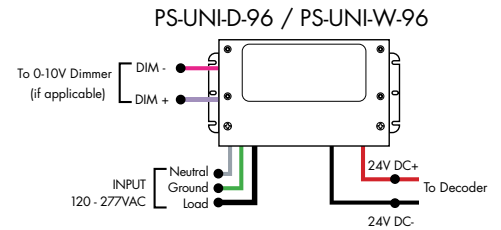

For use with Tunable White

DALI2 Dimming Power Supplies 0.1% 120VAC - 277VAC

MODEL	INPUT CONTROL	ENVIRONMENT	WATTAGE	OUTPUT	OUTPUT CONTROL
PS-Power Supply, 120-277VAC	DALI-DT8 -DALI DT8 Tunable White (0.1%)	D-Dry	96-96 Watts	24-24 VDC	PWM-Pulse Width Modulation

MODELS	96W
Length	14.40"
Width	5.20"
Depth	2.60"

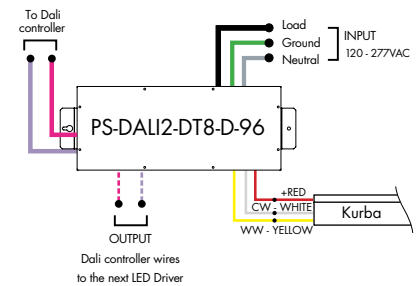

Athena DALI2-DT8 LED Driver

MODEL	INPUT CONTROL	ENVIRONMENT	WATTAGE	OUTPUT	FEATURE
PS-Power Supply, 120-277VAC	DALI-DT8 -DALI DT8 Tunable White	D-Dry	96-96 Watts	24-24 VDC	AWNR-Athena

MODELS	96W
Length	14.40"
Width	5.20"
Depth	2.60"

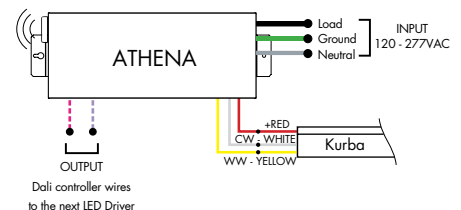

Power Supplies

See fixture and power supply instructions & spec sheet for wiring information. Dimming possible in select models - view Luminii website for list of compatible dimmers.

For use with Tunable White

VintageDim® 0 - 10V Dimming Power Supplies 0.1% 120VAC - 277VAC

MODEL	INPUT CONTROL	ENVIRONMENT	WATTAGE	OUTPUT
PS - Power Supply, 120-277VAC	010V-WD - 0-10V Dimming (0.1%), Standard Warm Dim Curve (with Tunable White LED) 010V-TW - 0-10V Dimming (0.1%), Two Channel Control, Brightness and CCT1-CCT2 Ratio 010V-2CH - 0-10V Dimming (0.1%), Two Channel Control, LED1 Brightness and LED2 Brightness 010V-WDX - 0-10V Dimming (0.1%), Customizable Warm Dim Curve (with Tunable White LED) 010V-2CHX - 0-10V Dimming (0.1%), Two Channel Control, Customizable Brightness and CCT1-CCT2 Ratio	D-Dry	96-96 Watts 3X96-3x96 Watts ¹	24-24 VDC

1 - 3x96 is only available with input control options 010V-WD and 010V-TW
 2 - Athena only available on 96 watts option

MODELS	96W	3X96
Length	14.40"	15.00"
Width	5.20"	6.62"
Depth	2.60"	4.56"

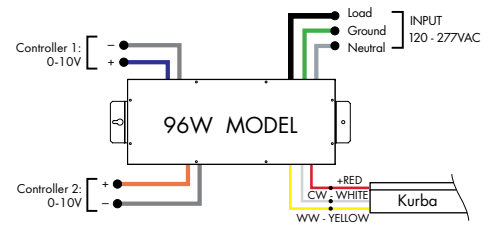
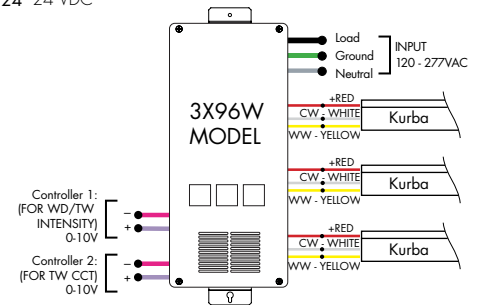

Athena 0-10V Warm Dim LED Driver

MODEL	INPUT CONTROL	ENVIRONMENT	WATTAGE	OUTPUT	FEATURE
PS - Power Supply, 120-277VAC	010V-WD - 0-10V Dimming, Standard Warm Dim Curve (with Dynamic White LED)	D-Dry	96-96 W	24-24 VDC	AWNDR-Athena

MODELS	96W
Length	14.40"
Width	5.20"
Depth	2.60"

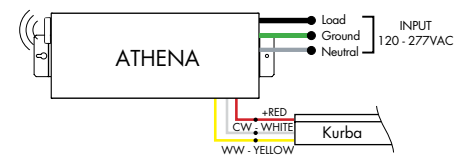

Athena 0-10V Two Channel LED Driver

MODEL	INPUT CONTROL	ENVIRONMENT	WATTAGE	OUTPUT	FEATURE
PS - Power Supply, 120-277VAC	010V-2CH - 0-10V Dimming Two Channel Control, LED1 Brightness and LED2 Brightness	D-Dry	96-96 W	24-24 VDC	AWNDR-Athena

MODELS	96W
Length	14.40"
Width	5.20"
Depth	2.60"

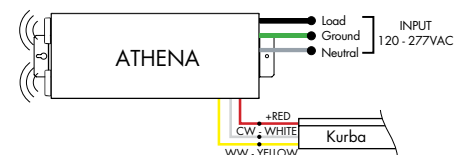

Power Supplies

See fixture and power supply instructions & spec sheet for wiring information. Dimming possible in select models - view Luminii website for list of compatible dimmers.

For use with RGB/RGBW, Tunable White

Requires Controller

DMX Dimming Power Supplies 0.1% 120VAC - 277VAC

MODEL	INPUT CONTROL	ENVIRONMENT	WATTAGE	OUTPUT
PS-Power Supply, 120-277VAC	DMX-DMX (0.1%)	D-Dry	96-96 Watts 3X96-3X96 Watts	24-24 VDC

MODELS	96W	3X96
Length	14.40"	15.00"
Width	5.20"	6.62"
Depth	2.60"	4.56"

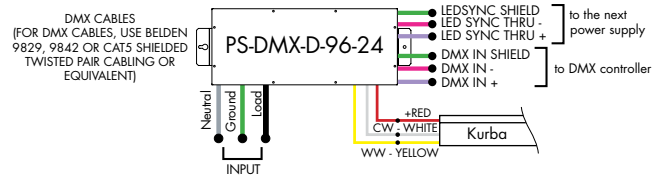
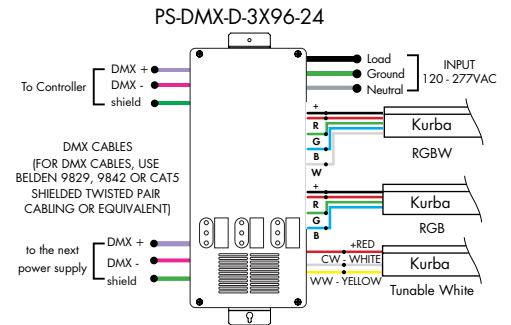

Controllers and Decoders

For use with Tunable White Power Supplies



ORDERING CODE

MODEL

DTW-MC

DTW-MC - Tunable White controller

Tunable White wall-mount controller controls lighting fixtures, wireless control of TW lighting fixture. Fits in any standard US switch box. Includes all the outputs in the back of the controller.

Features

- Switch & dimming control function, control range > 20M.
- Smooth transition between light levels.
- Separately operate dimming and color temperature functions.
- Able to control 1 zone with endless receivers. Each receiver can maximally be controlled by 8 remotes.
- Power, temperature color and dimming functions operated by push button after receivers are connected.

Operating Voltage

3V DC battery

Color Parameters

- Brightness
- Saturation
- Fading

Controllers and Decoders

For use with Tunable White Power Supplies



ORDERING CODE

MODEL

TW-DMX

TW-DMX - DMX controller

Tunable White DMX wall-mount controller is a fully touch sensitive controller designed in accordance with standard protocol DMX512. Offers fast and accurate color temperature adjustment and brightness dimming of natural white, warm white and cold white. Designed with a touch color wheel, the DMX512 controller can adjust color temperature and brightness for all white LEDs smoothly and accurately. The DMX controller can control 1 zone with endless decoders.

Features

- 1 zone
- 6 color scenes
- DMX Control
- Touch Sensitive Glass Surface
- Dimming and Speed Control
- Memory Function
- Easily Fits Standard US Switch Boxes

Operating Voltage

12 - 24V DC

Color Parameters

- Brightness
- Saturation
- Primary colors
- Fading
- Color changing speed



ORDERING CODE

MODEL

SLD-DIMTW

SLD-DIMTW - Tunable white LED dimming module

The SLD DimTW is a constant voltage warm dimming LED dimming module. The unique dimming module accepts 0-10V control and mimics a smooth, incandescent dimming curve.

Features

- Flicker free 0-100% dimming
- High efficiency up to 97%
- High precision dimming ratio:>1:1000
- Fully isolated plastic housing
- Comply with EN55015 and FCC part 15 without additional input filter and capacitors
- compact size, high reliability
- 3 years warranty

Operating Voltage

8-48 VDC