

Krest Reveal Installation Instructions

Krest Mud-In

Please read all instructions prior to installation and keep for future reference!

1. PRODUCT TO BE INSTALLED BY A QUALIFIED ELECTRICIAN
2. USE ONLY WITH CLASS 2 POWER UNIT
3. 24 VOLTS DC
4. SUITABLE FOR DRY LOCATIONS ONLY



REVO.0
05152026

1 / 17



7777 Merrimac Ave
Niles, IL 60714
T 224.333.6033
F 224.757.7557
info@luminii.com
www.luminii.com

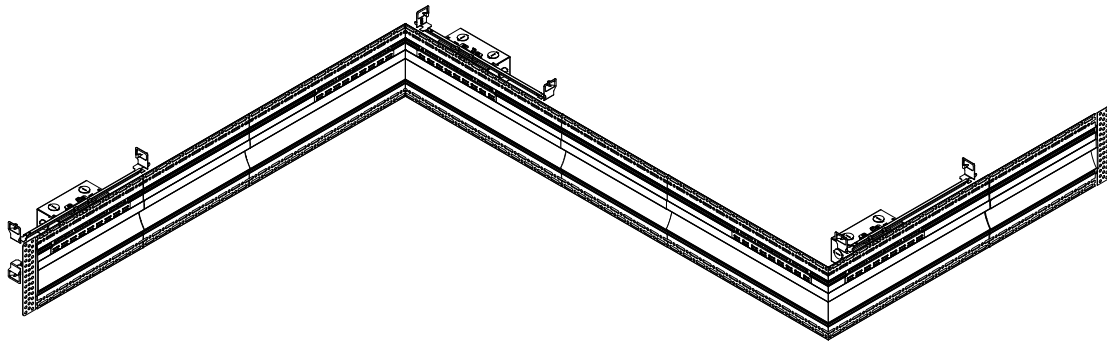

Scan the QR code for [Video Installation Guide](#)

*LUMINII RESERVES THE RIGHTS TO CHANGE SPECIFICATION & INSTRUCTION WITHOUT NOTICE

Krest Reveal Installation Instructions

Krest Mud-In

Please read all instructions prior to installation and keep for future reference!

1. PRODUCT TO BE INSTALLED BY A QUALIFIED ELECTRICIAN
2. USE ONLY WITH CLASS 2 POWER UNIT
3. 24 VOLTS DC
4. SUITABLE FOR DRY LOCATIONS ONLY



REVO.0
05152026

2 / 17



7777 Merrimac Ave
Niles, IL 60714
T 224.333.6033
F 224.757.7557
info@luminii.com
www.luminii.com

Components Overview

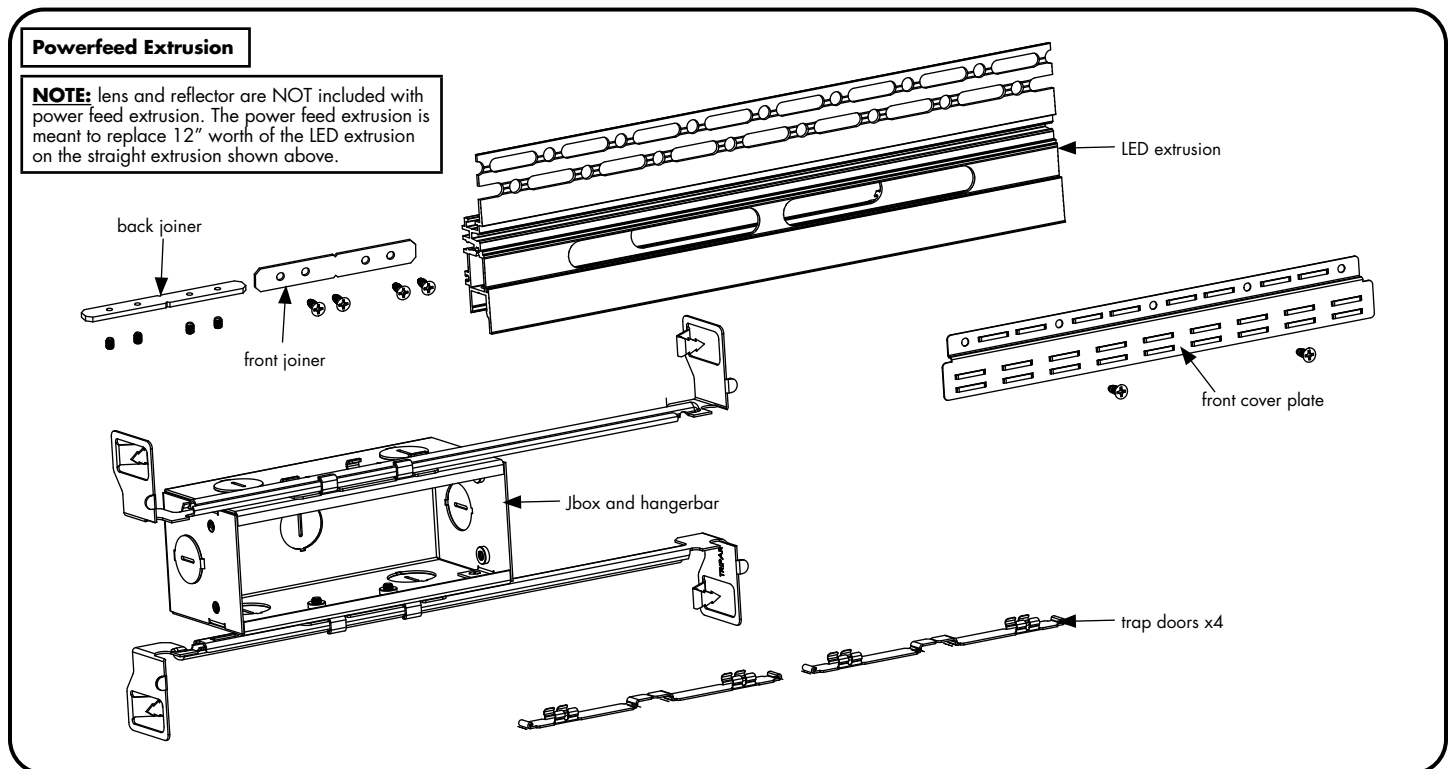
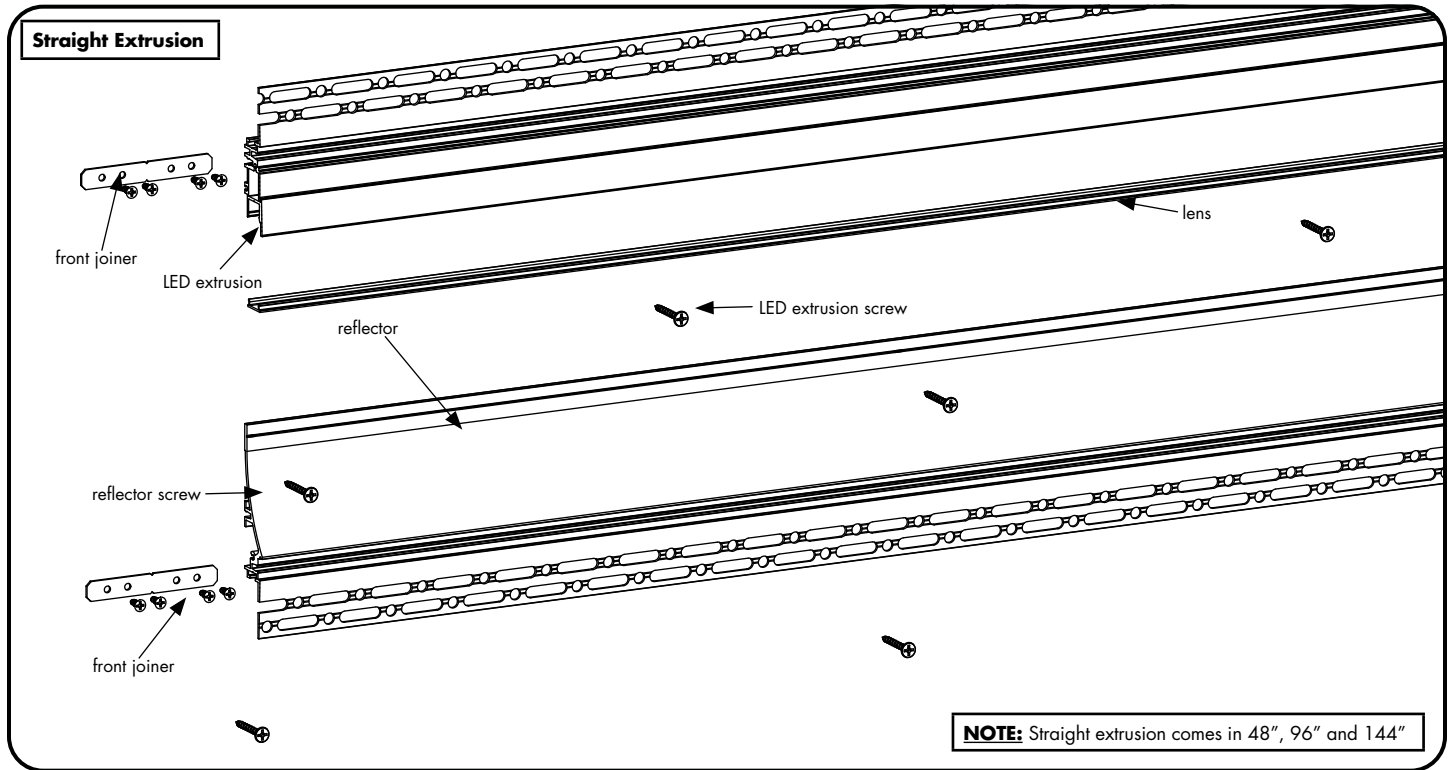

Krest Reveal Installation Instructions

Krest Mud-In

Please read all instructions prior to installation and keep for future reference!

1. PRODUCT TO BE INSTALLED BY A QUALIFIED ELECTRICIAN
2. USE ONLY WITH CLASS 2 POWER UNIT
3. 24 VOLTS DC
4. SUITABLE FOR DRY LOCATIONS ONLY



REVO.0
05152026

3 / 17



7777 Merrimac Ave
Niles, IL 60714
T 224.333.6033
F 224.757.7557
info@luminii.com
www.luminii.com

Components Overview

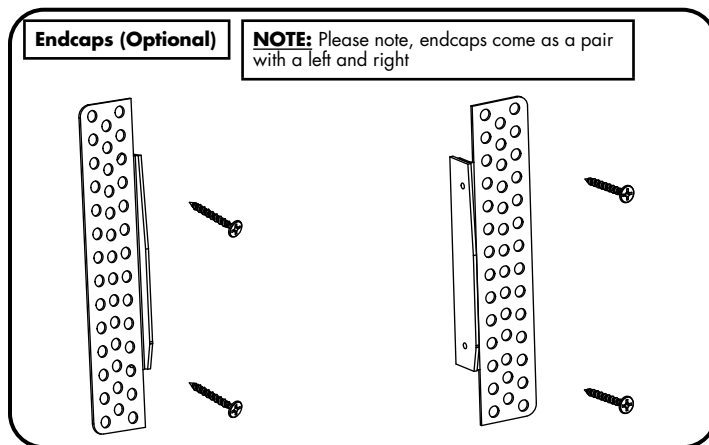
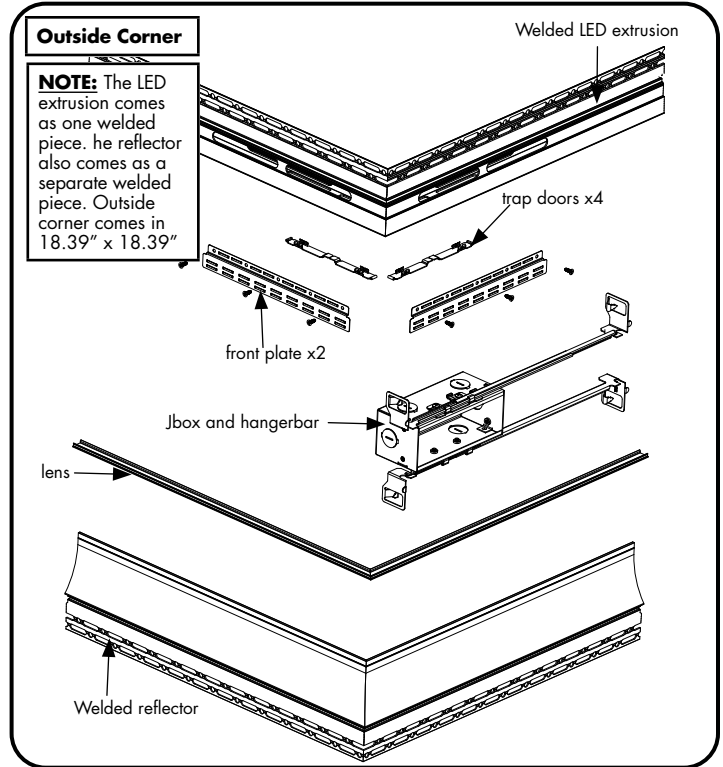
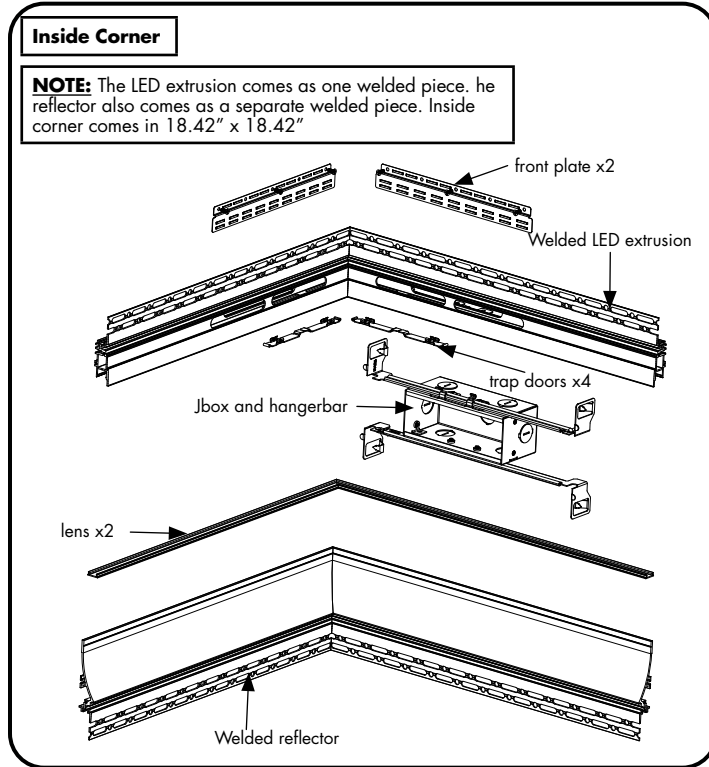

Krest Reveal Installation Instructions

Krest Mud-In

Please read all instructions prior to installation and keep for future reference!

1. PRODUCT TO BE INSTALLED BY A QUALIFIED ELECTRICIAN
2. USE ONLY WITH CLASS 2 POWER UNIT
3. 24 VOLTS DC
4. SUITABLE FOR DRY LOCATIONS ONLY



REVO.0
05152026

4 / 17



7777 Merrimac Ave
Niles, IL 60714
T 224.333.6033
F 224.757.7557
info@luminii.com
www.luminii.com

Installation Cross-Section View

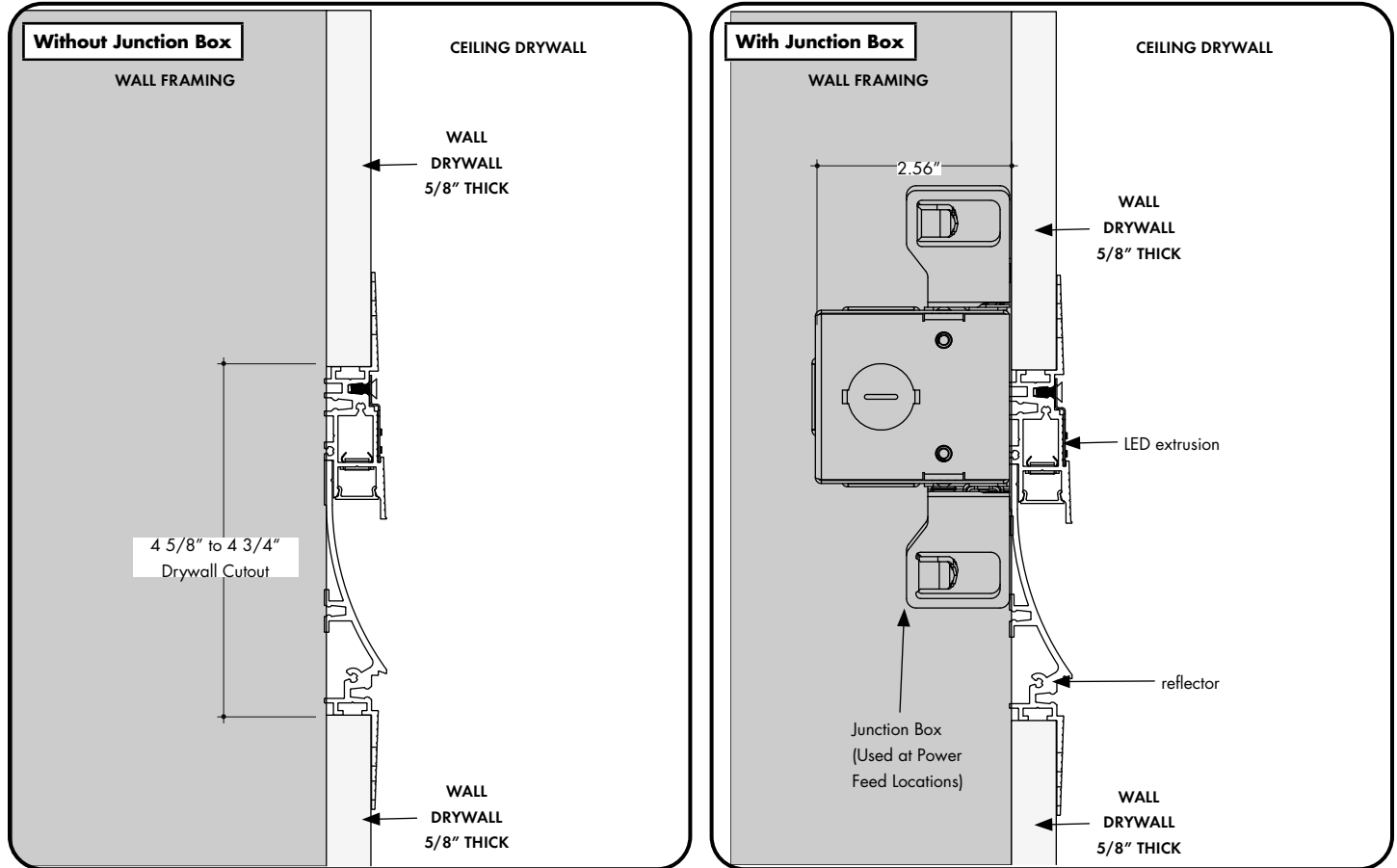

Krest Reveal Installation Instructions

Krest Mud-In



7777 Merrimac Ave
Niles, IL 60714
T 224.333.6033
F 224.757.7557
info@luminii.com
www.luminii.com

REVO.0
05152026

5 / 17

Please read all instructions prior to installation and keep for future reference!

1. PRODUCT TO BE INSTALLED BY A QUALIFIED ELECTRICIAN
2. USE ONLY WITH CLASS 2 POWER UNIT
3. 24 VOLTS DC
4. SUITABLE FOR DRY LOCATIONS ONLY

Junction Box Installation

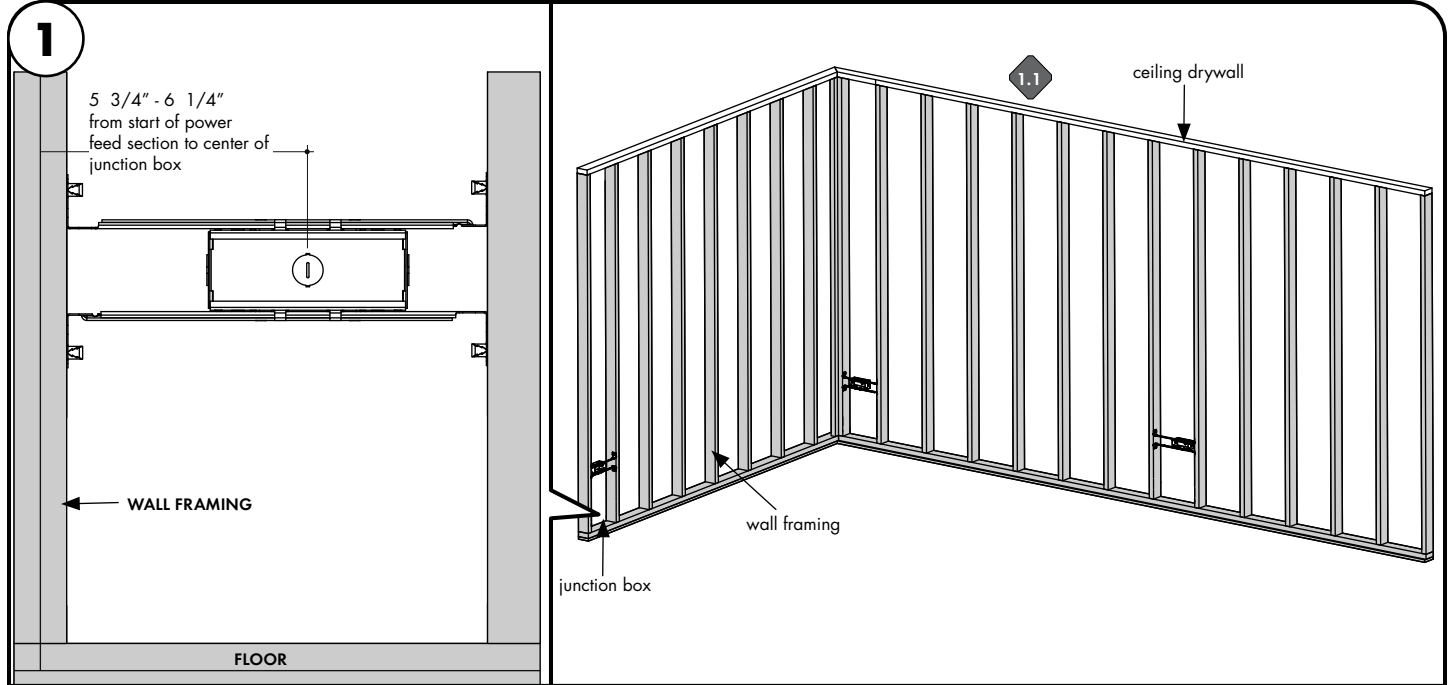

1.1 Identify power feed locations and install junction boxes to the wall framing as shown.

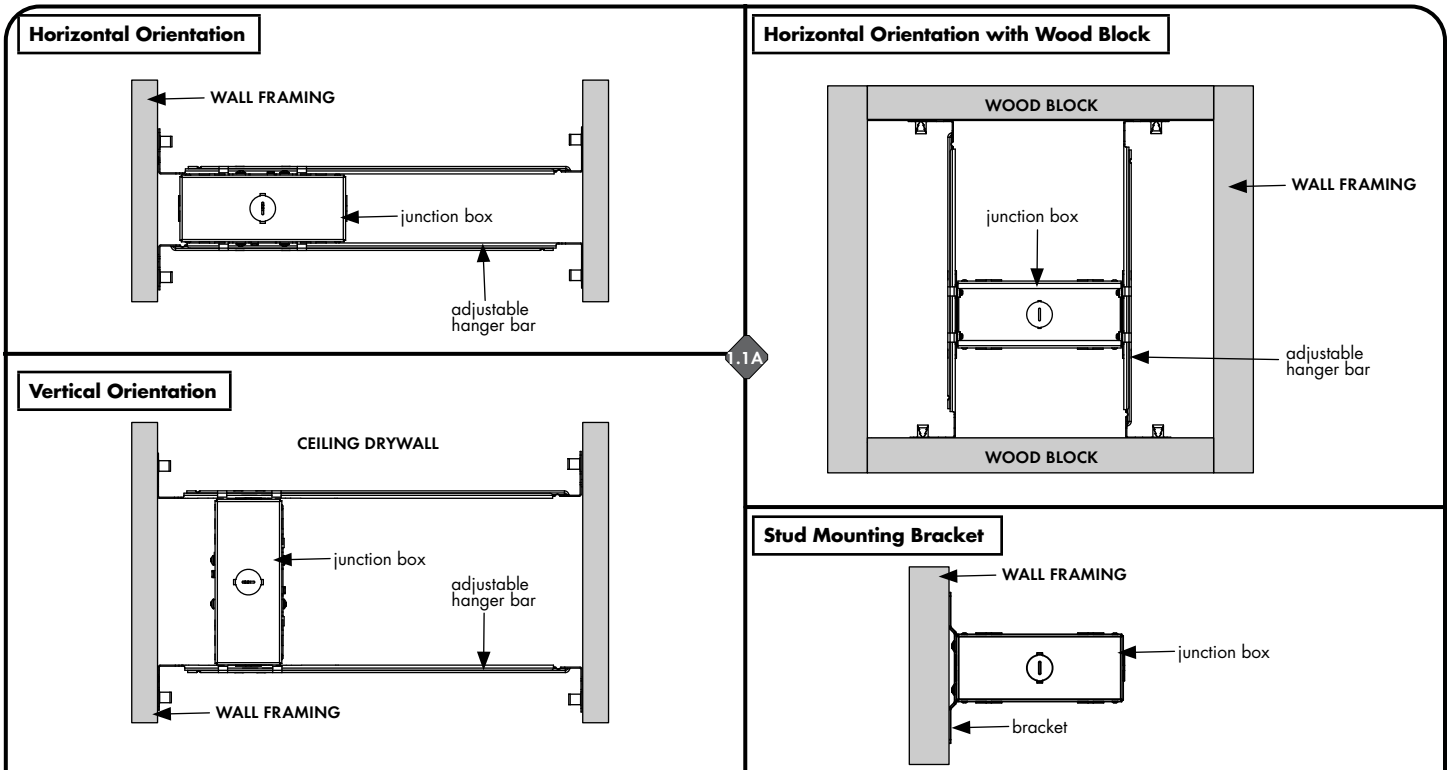

1.1A The Junction Box can be installed to the wall framing using the adjustable hanger bars or stud mounting bracket as shown.

Krest Reveal Installation Instructions

Krest Mud-In

Please read all instructions prior to installation and keep for future reference!

1. PRODUCT TO BE INSTALLED BY A QUALIFIED ELECTRICIAN
2. USE ONLY WITH CLASS 2 POWER UNIT
3. 24 VOLTS DC
4. SUITABLE FOR DRY LOCATIONS ONLY



REVO.0
05152026

6 / 17



7777 Merrimac Ave
Niles, IL 60714
T 224.333.6033
F 224.757.7557
info@luminii.com
www.luminii.com

Junction Box Installation

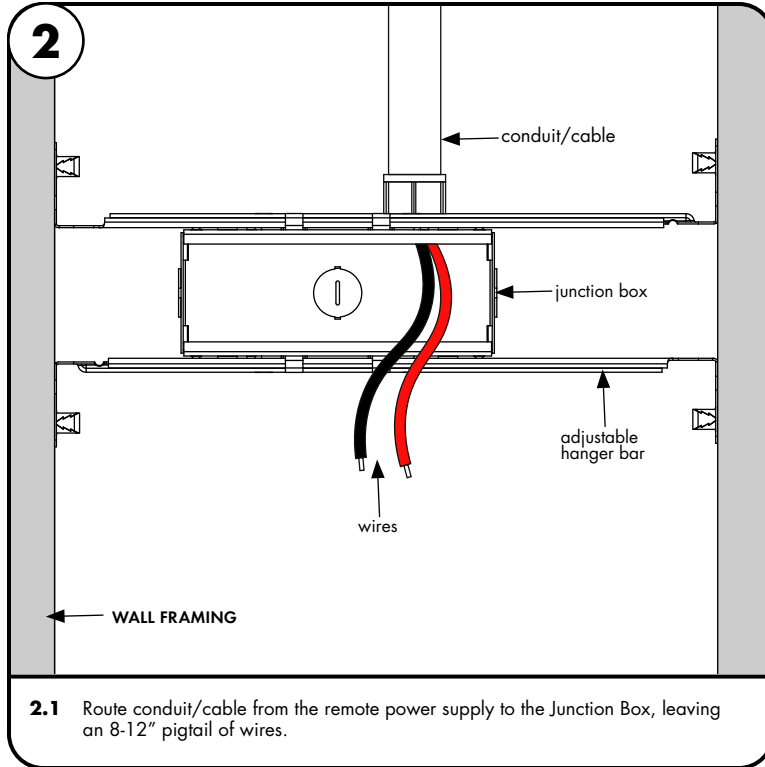

Drywall Installation

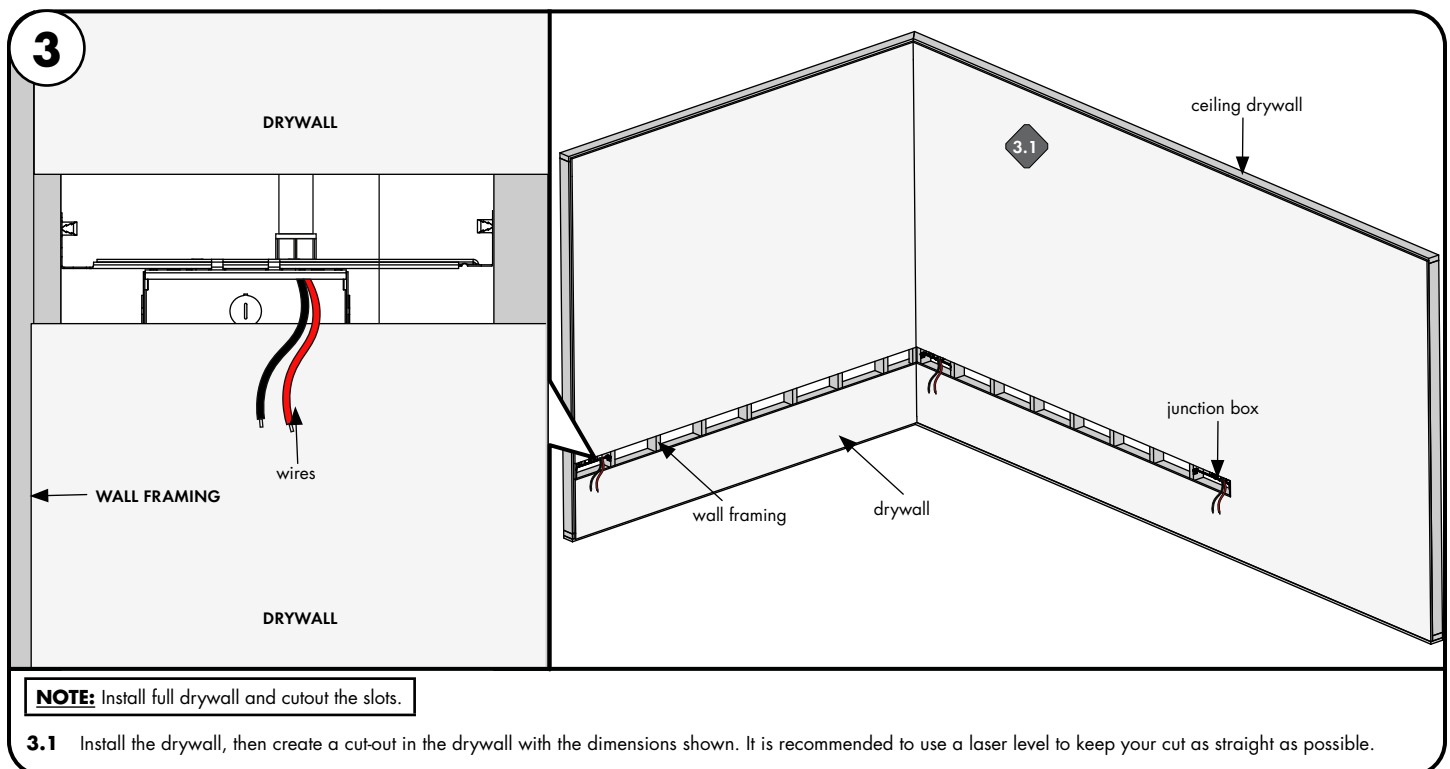

Krest Reveal Installation Instructions

Krest Mud-In

Please read all instructions prior to installation and keep for future reference!

1. PRODUCT TO BE INSTALLED BY A QUALIFIED ELECTRICIAN
2. USE ONLY WITH CLASS 2 POWER UNIT
3. 24 VOLTS DC
4. SUITABLE FOR DRY LOCATIONS ONLY



REVO.0
05152026

7 / 17



7777 Merrimac Ave
Niles, IL 60714
T 224.333.6033
F 224.757.7557
info@luminii.com
www.luminii.com

Reflector Installation

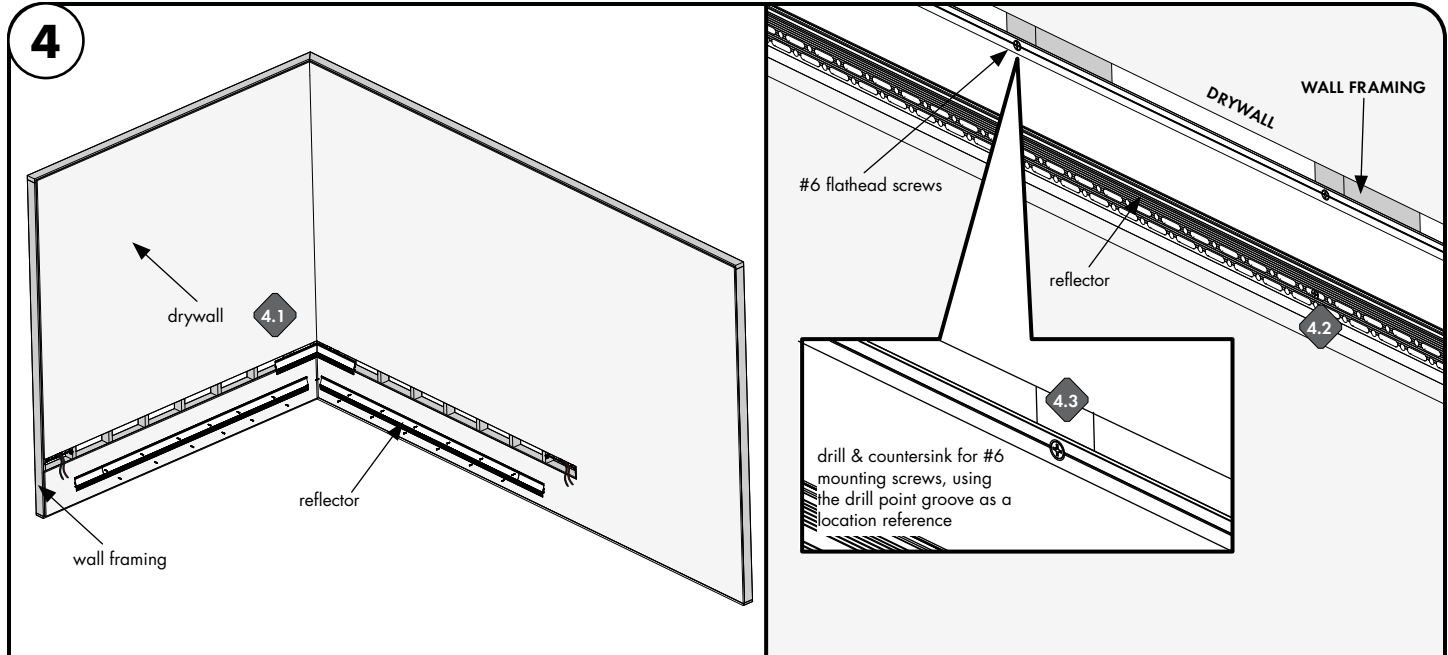

NOTE: Always install corner piece first

- 4.1** Measure and cut Reflectors to length to fit inside the drywall cutout. Mark stud/blocking locations on the Reflectors and then drill & countersink holes along the drill point groove for the mounting screws. countersink should be big enough for #6 flathead screws
- 4.2** Secure the reflectors to the wall framing using #6 flathead screws. Note: The screw head must be flush with the reflector, otherwise there will be interference with the LED Extrusion. Countersink should be big enough for #6 flathead screws.
- 4.3** Apply caulk or plaster to cover seams of the Reflectors. If desired, paint the Reflector using a matte finish.

Krest Reveal Installation Instructions

Krest Mud-In



7777 Merrimac Ave
Niles, IL 60714
T 224.333.6033
F 224.757.7557
info@luminii.com
www.luminii.com

REVO.0
05152026

8 / 17

Please read all instructions prior to installation and keep for future reference!

1. PRODUCT TO BE INSTALLED BY A QUALIFIED ELECTRICIAN
2. USE ONLY WITH CLASS 2 POWER UNIT
3. 24 VOLTS DC
4. SUITABLE FOR DRY LOCATIONS ONLY

Joiner Power Feed Section to LED Extrusion

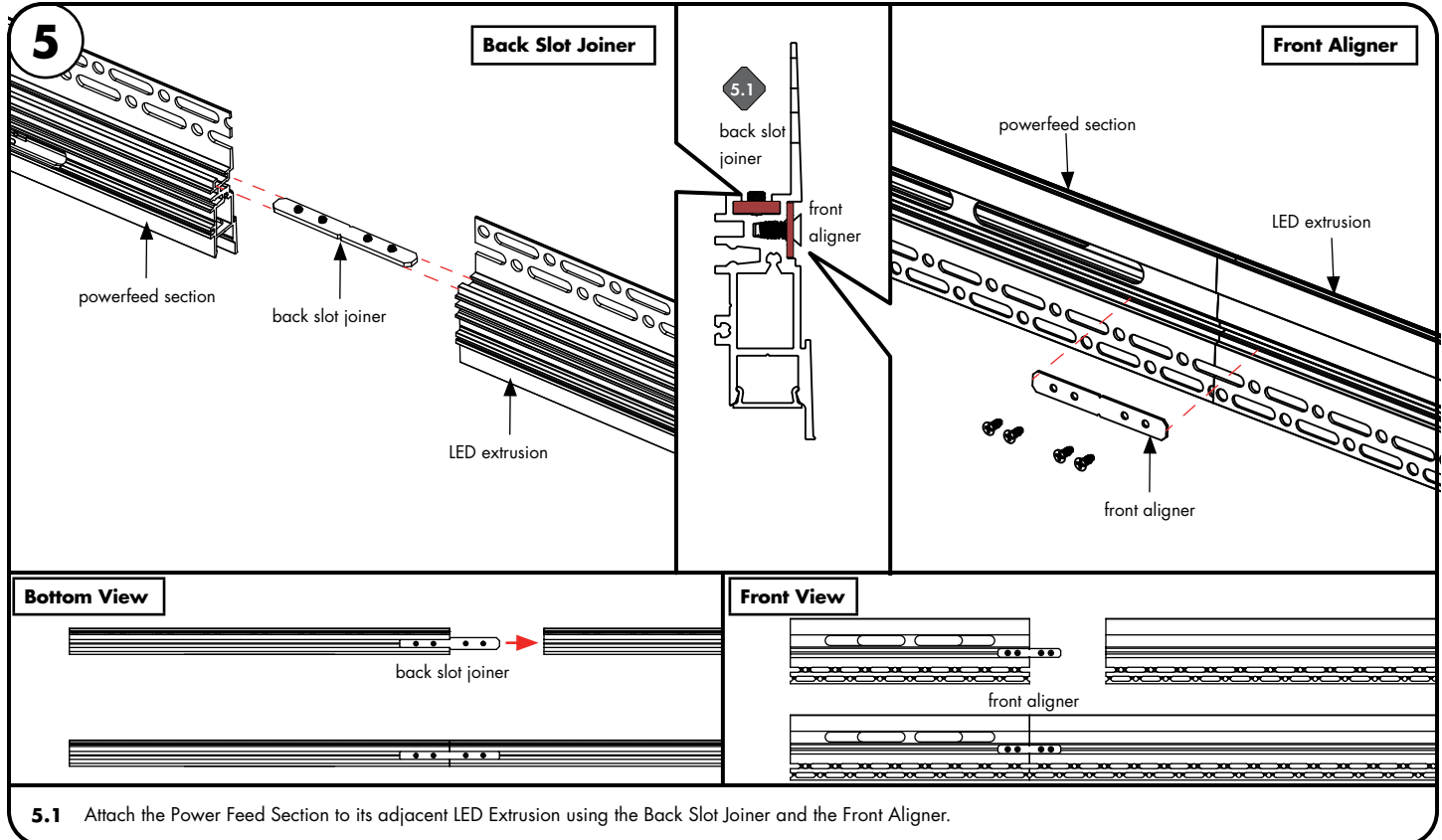

5.1 Attach the Power Feed Section to its adjacent LED Extrusion using the Back Slot Joiner and the Front Aligner.

LED Extrusions Installation

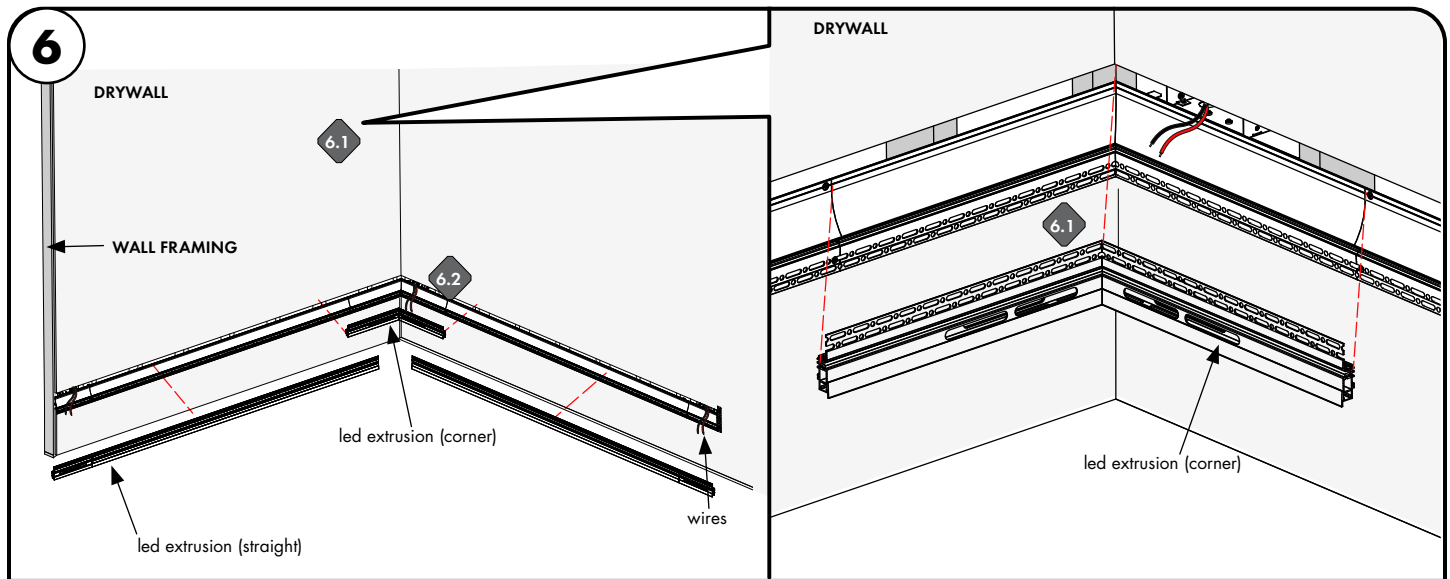

NOTE: Always install corner piece first

- 6.1 Measure and cut LED Extrusions to length to fit inside the drywall cutout.
- 6.2 Start with installing the welded corner pieces and then install the straight LED Extrusion pieces.

Krest Reveal Installation Instructions

Krest Mud-In



7777 Merrimac Ave
Niles, IL 60714
T 224.333.6033
F 224.757.7557
info@luminii.com
www.luminii.com

REVO.0
05152026

9 / 17

Please read all instructions prior to installation and keep for future reference!

1. PRODUCT TO BE INSTALLED BY A QUALIFIED ELECTRICIAN
2. USE ONLY WITH CLASS 2 POWER UNIT
3. 24 VOLTS DC
4. SUITABLE FOR DRY LOCATIONS ONLY

LED Extrusions Installation

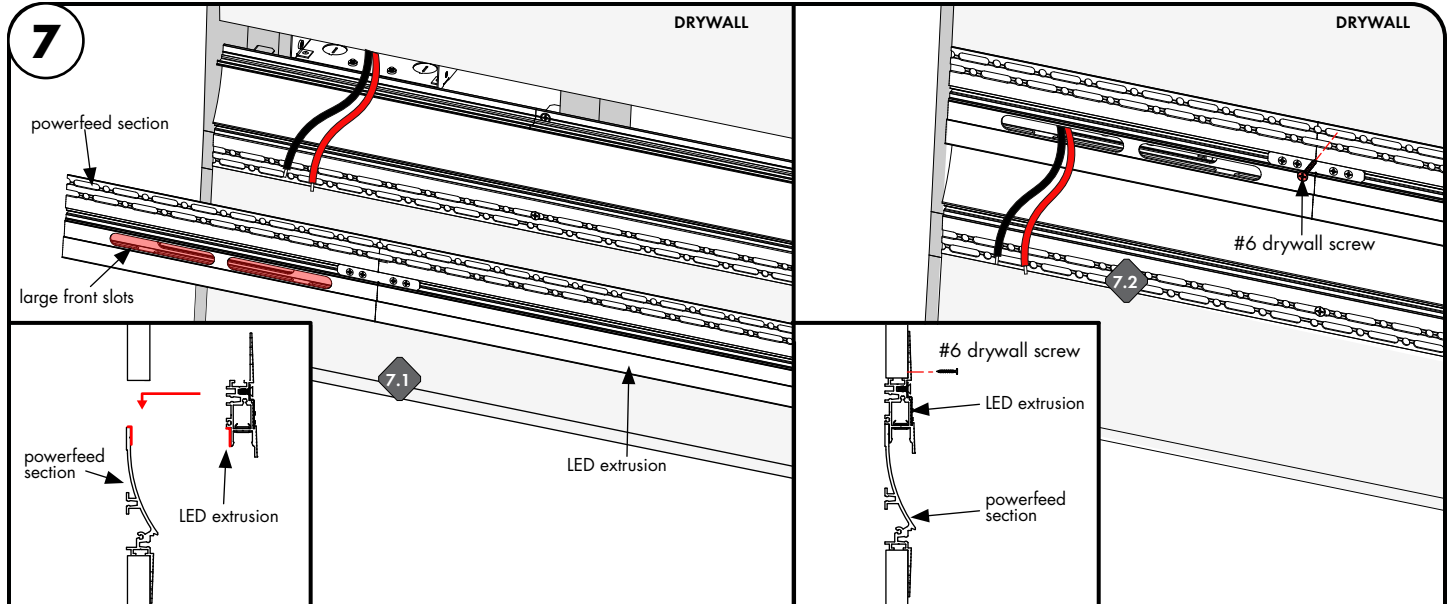

NOTE: Powerfeed extrusion should be joined to LED extrusion before installing to the wall.

- 7.1 At Junction Box locations, route the power supply wires through the large front slots in the Power Feed Section.
- 7.2 Position the LED Extrusion up against the Reflector, then fasten the LED Extrusion to the wall framing using #6 drywall screws. Suggested minimum spacing for the screws is 16" to prevent cracking of the plaster. Ensure screw pierces wood blocking (studs) as well as drywall.

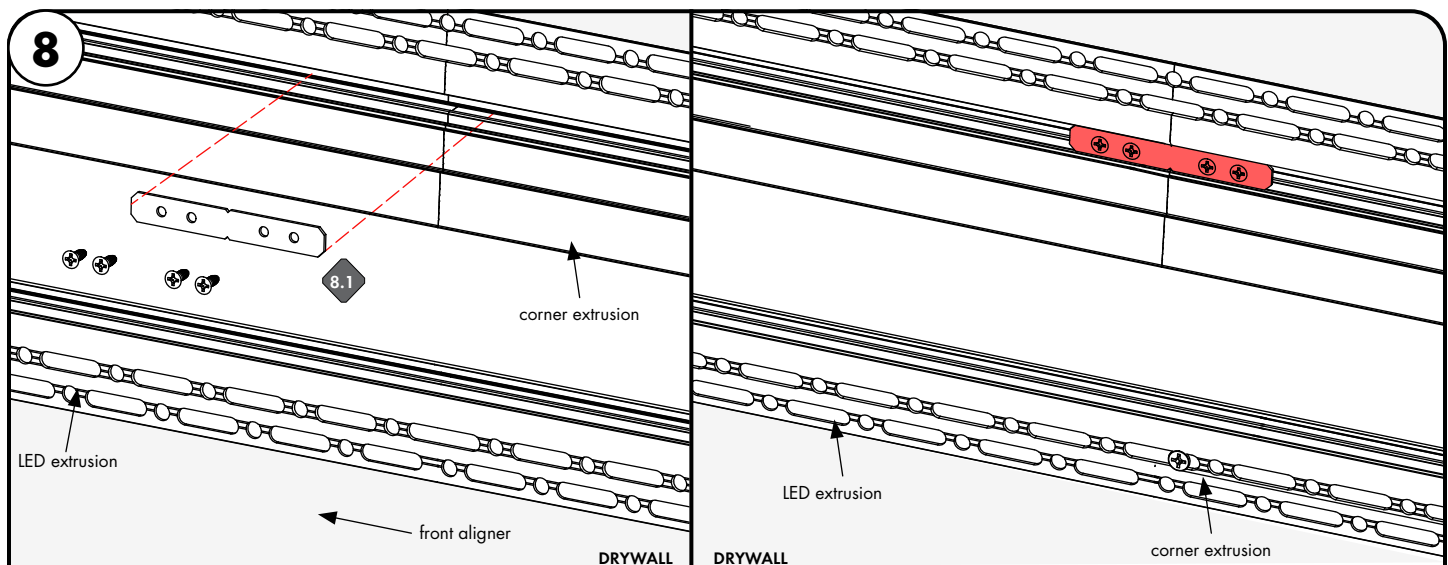

NOTE: For Joining LED extrusions and corner extrusions.

- 8.1 At joints between adjacent LED Extrusions, install the Front Aligner using provided screws.

Krest Reveal Installation Instructions

Krest Mud-In

Please read all instructions prior to installation and keep for future reference!

1. PRODUCT TO BE INSTALLED BY A QUALIFIED ELECTRICIAN
2. USE ONLY WITH CLASS 2 POWER UNIT
3. 24 VOLTS DC
4. SUITABLE FOR DRY LOCATIONS ONLY



REVO.0
05152026

10 / 17



7777 Merrimac Ave
Niles, IL 60714
T 224.333.6033
F 224.757.7557
info@luminii.com
www.luminii.com

Endcap Installation (if terminating run mid-wall)

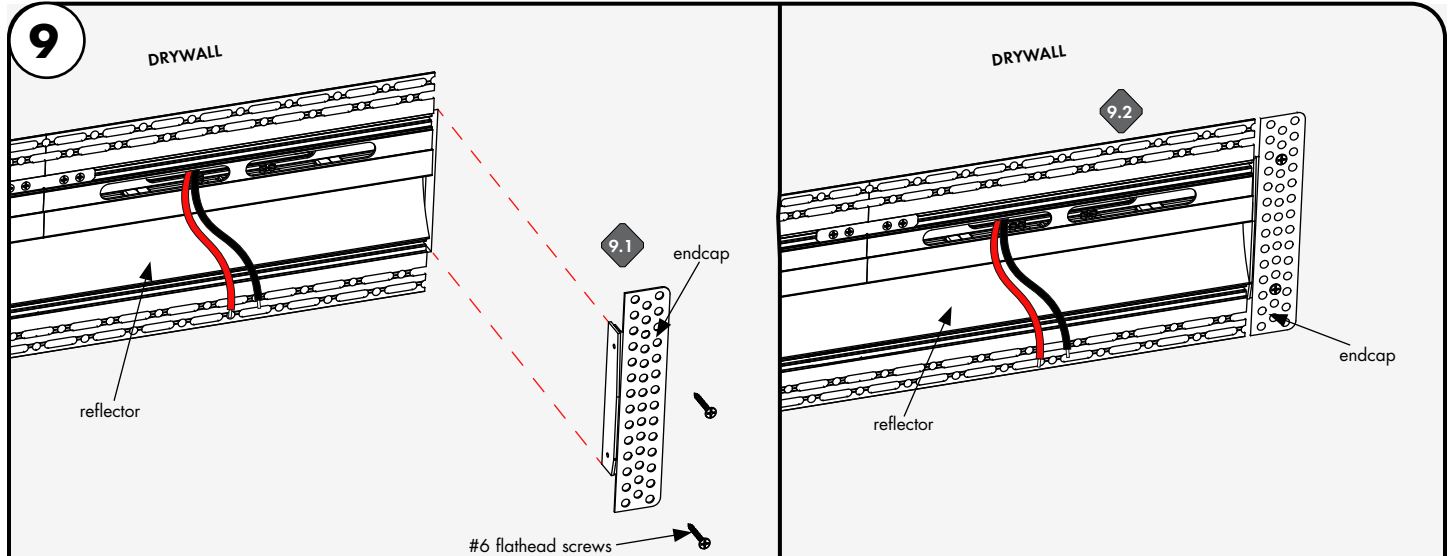

9.1 Install the endcap(s) using #6 drywall screws fastened to the wall framing as shown below.

9.2 Apply caulk or plaster to cover seams between the Endcap and Reflector. Please note, endcaps do not mechanically attach to the LED extrusion or Reflector

LED Tape Installation - Before Plastering/Painting

Recommended for soldered LED strip install (If using minii connectors, skip to page 14)

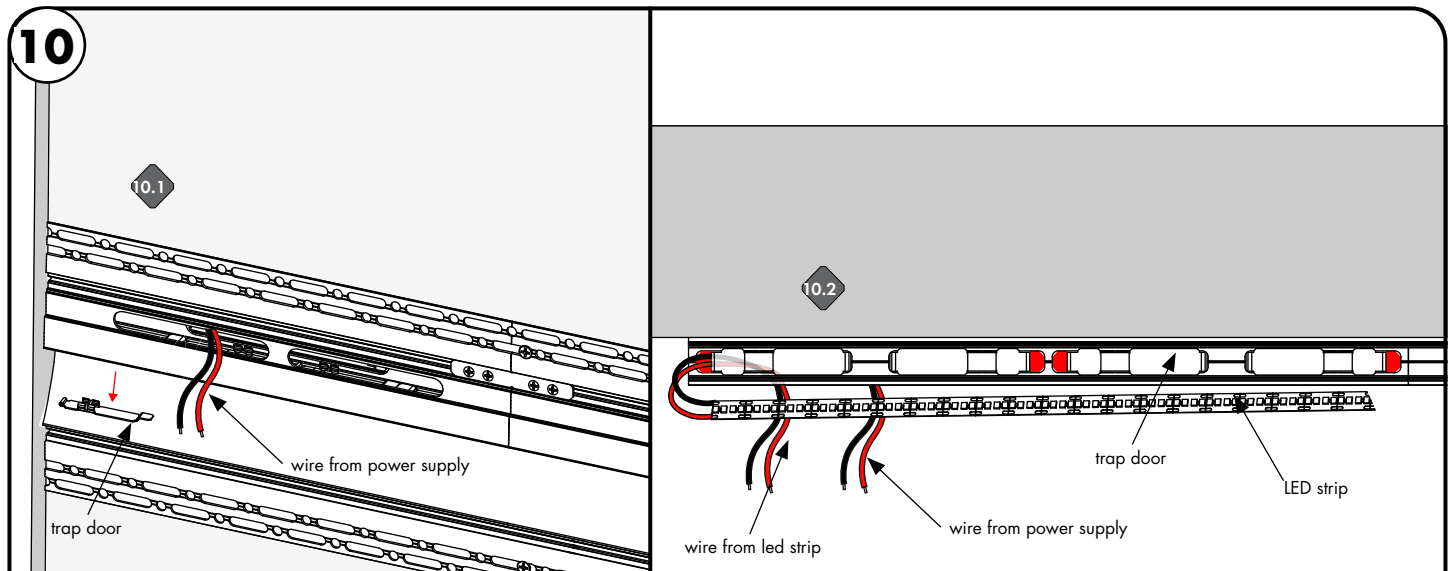

NOTE: Make sure trap doors are installed as shown.

10.1 Remove the trap doors. Route the wire from the LED strip through the trap door slot.

10.2 Snap the trap door back into place. Note Symmetric orientation of trap doors. Highlighted in red is open space for LED strip wiring.

Krest Reveal Installation Instructions

Krest Mud-In

Please read all instructions prior to installation and keep for future reference!

1. PRODUCT TO BE INSTALLED BY A QUALIFIED ELECTRICIAN
2. USE ONLY WITH CLASS 2 POWER UNIT
3. 24 VOLTS DC
4. SUITABLE FOR DRY LOCATIONS ONLY



REVO.0
05152026

11 / 17



7777 Merrimac Ave
Niles, IL 60714
T 224.333.6033
F 224.757.7557
info@luminii.com
www.luminii.com

LED Tape Installation - Before Plastering/Painting

Recommended for soldered LED strip install

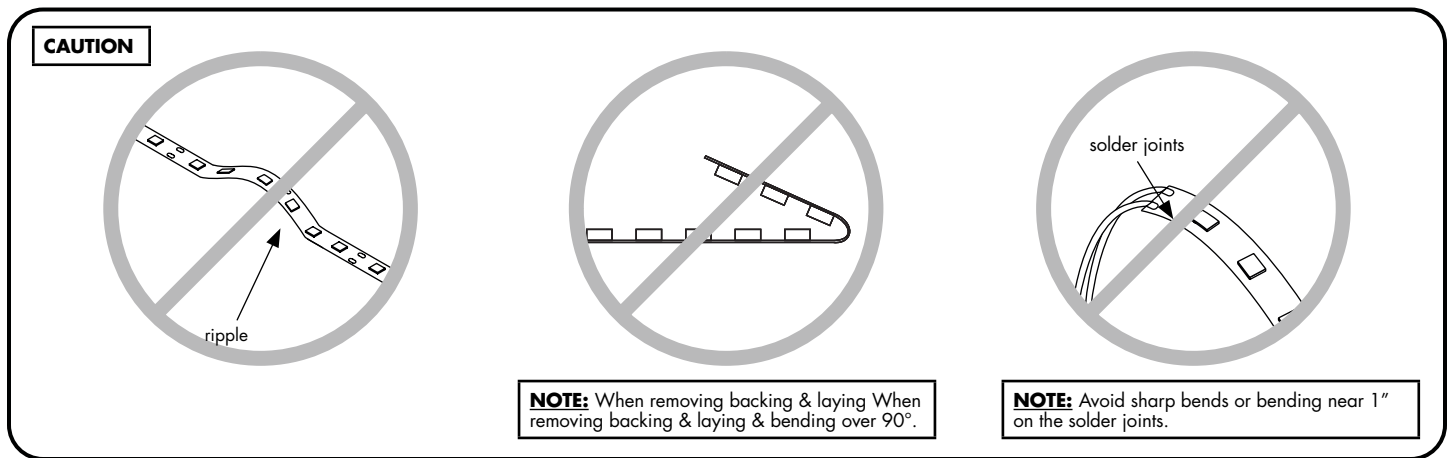
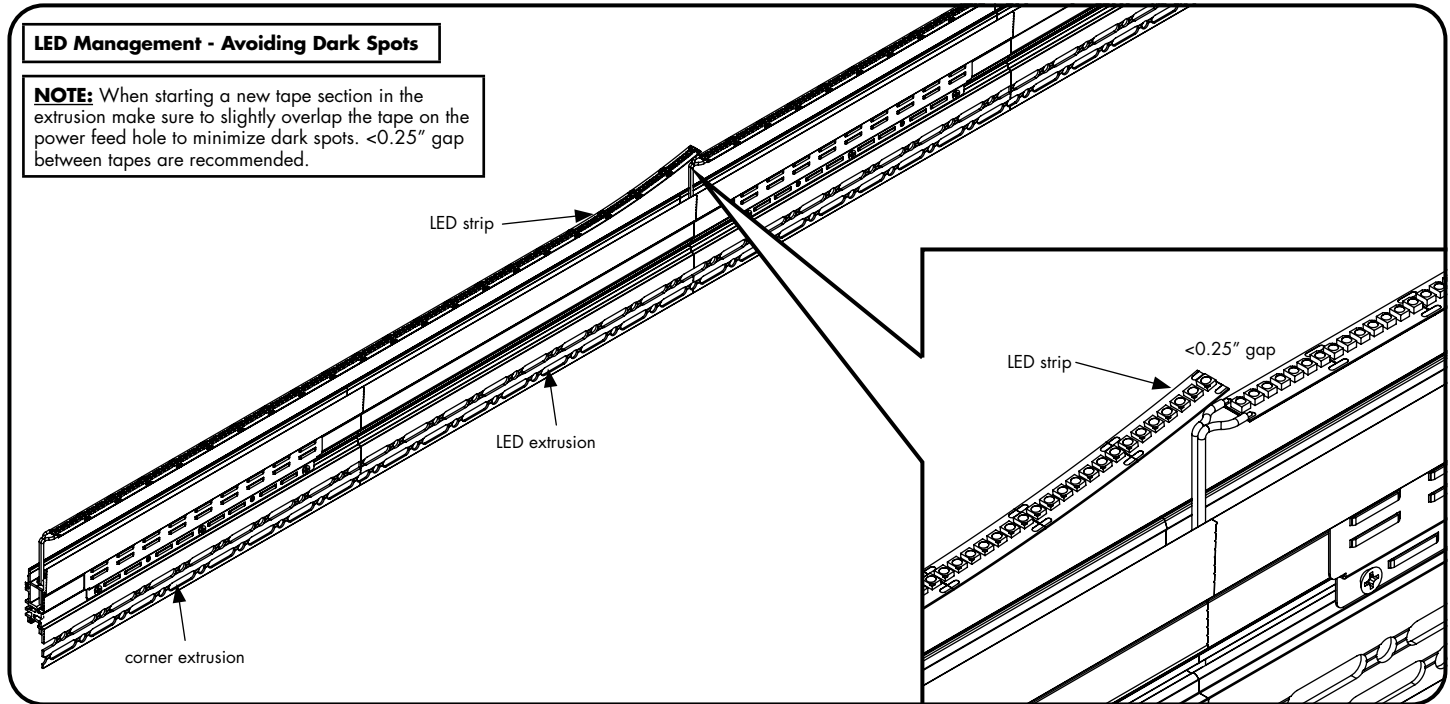

Krest Reveal Installation Instructions

Krest Mud-In



7777 Merrimac Ave
Niles, IL 60714
T 224.333.6033
F 224.757.7557
info@luminii.com
www.luminii.com

REVO.0
05152026

12 / 17

Please read all instructions prior to installation and keep for future reference!

1. PRODUCT TO BE INSTALLED BY A QUALIFIED ELECTRICIAN
2. USE ONLY WITH CLASS 2 POWER UNIT
3. 24 VOLTS DC
4. SUITABLE FOR DRY LOCATIONS ONLY

LED Tape Installation - Before Plastering/Painting

Recommended for soldered LED strip install

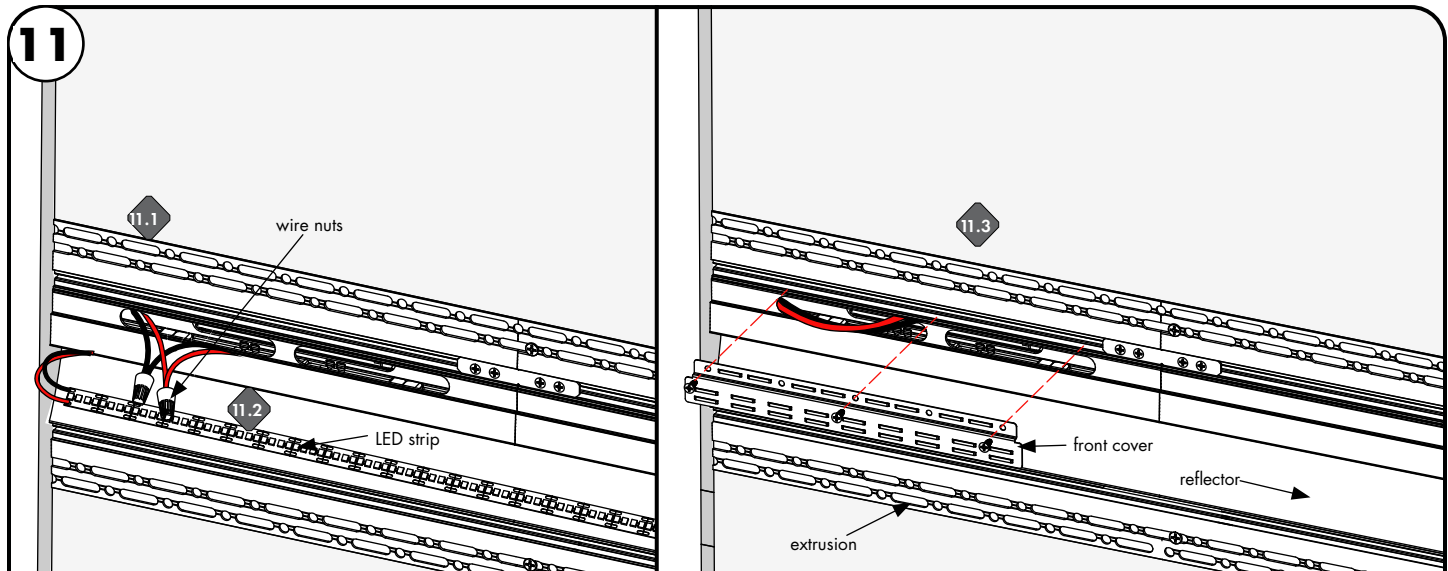

- 11.1** Take the soldered LED strip then route the wires down through the Power Feed Section trapdoor opening and out through the front slots while affixing the LED Tape's adhesive backing to the LED Extrusion. LED strip will rest on top of the trap door covers.
- 11.2** Connect to the power supply wires using wire nuts/connectors. Tuck the wires through the front slots and into the Junction Box.
- 11.3** Attach the Front Cover to the Power Feed Section using the provided screws.

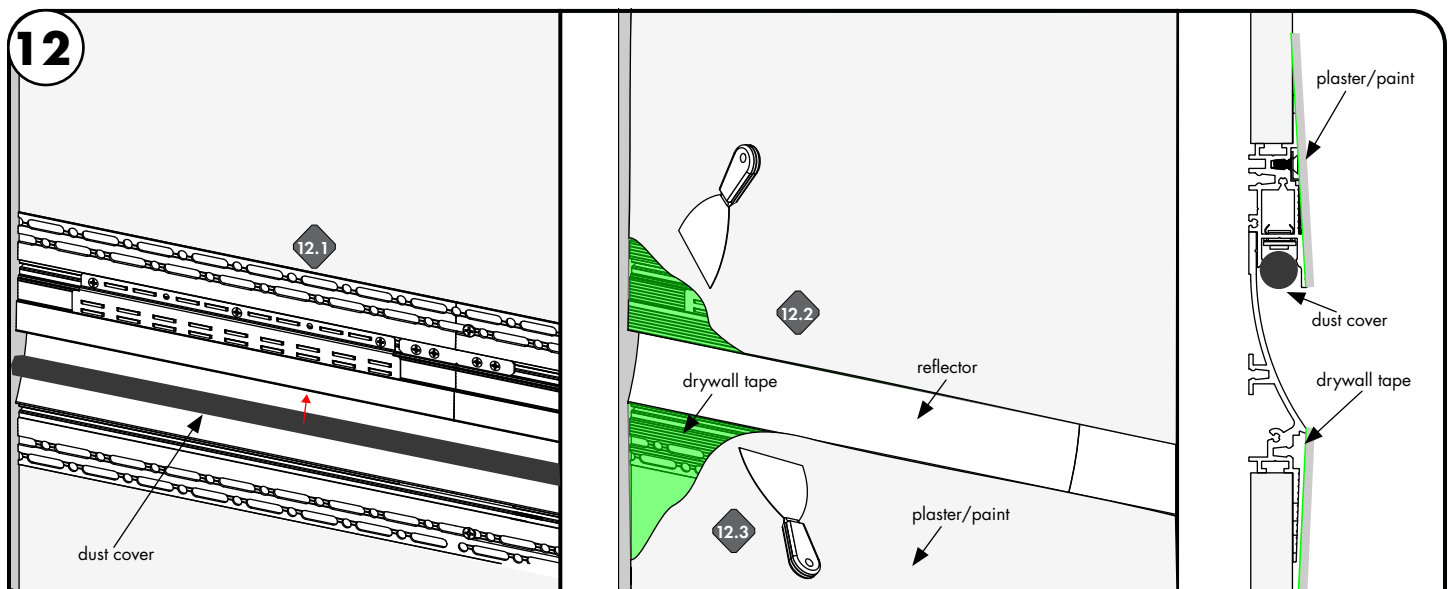

- 12.1** Insert the foam dust protector into the LED Extrusion channel.
- 12.2** Apply thin drywall tape overlapping the LED Extrusion flange and drywall. Apply plaster to the LED Extrusion, feathering 12-16" away. Multiple coats of plaster may be required to fill in the thicker cavities of the LED Extrusion and provide a smooth even surface.
- 12.3** Sand the plastered surface and apply paint.

Krest Reveal Installation Instructions

Krest Mud-In

Please read all instructions prior to installation and keep for future reference!

1. PRODUCT TO BE INSTALLED BY A QUALIFIED ELECTRICIAN
2. USE ONLY WITH CLASS 2 POWER UNIT
3. 24 VOLTS DC
4. SUITABLE FOR DRY LOCATIONS ONLY

LED Tape Installation - Before Plastering/Painting

Recommended for soldered LED strip install



REVO.0
05152026

13 / 17



7777 Merrimac Ave
Niles, IL 60714
T 224.333.6033
F 224.757.7557
info@luminii.com
www.luminii.com

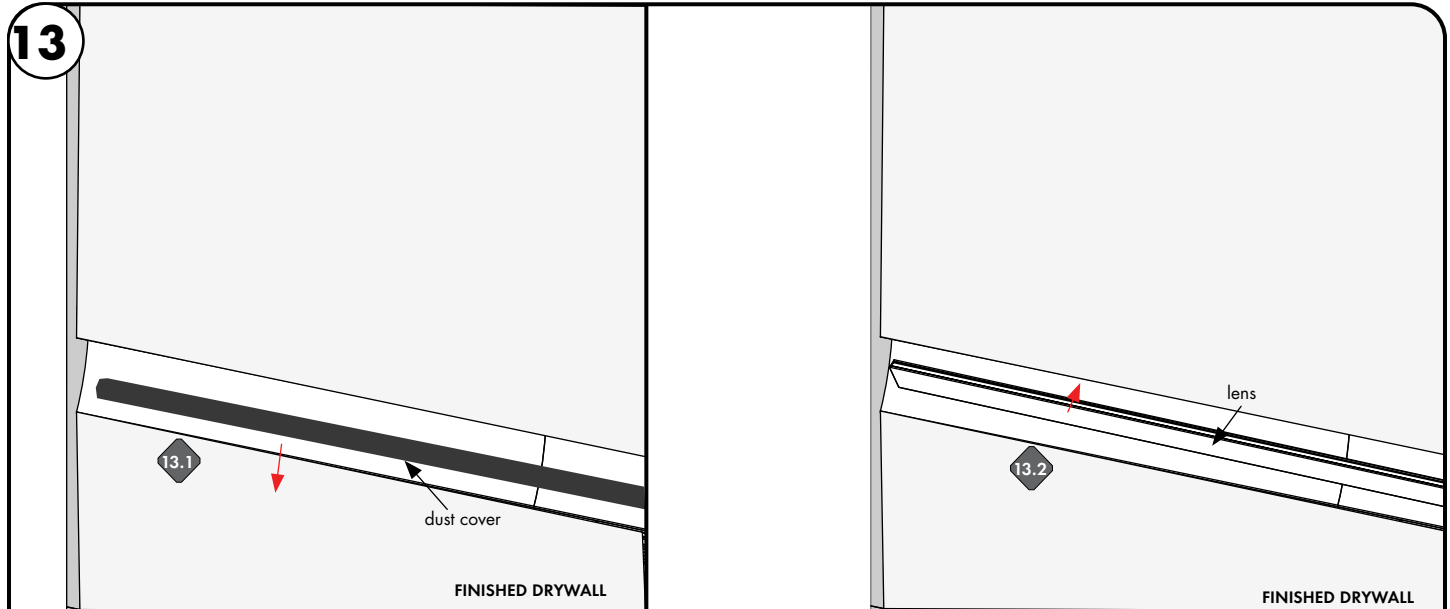

NOTE: DO NOT push the lens too far into extrusion.

- 13.1** Clean any remaining dust/debris off the foam dust cover before removing it to avoid dust/debris falling on the LED strip during the removal process. Remove Foam Dust Cover. Clean any remaining dust/debris off the LED.
- 13.2** Snap in the Lens.

Krest Reveal Installation Instructions

Krest Mud-In



7777 Merrimac Ave
Niles, IL 60714
T 224.333.6033
F 224.757.7557
info@luminii.com
www.luminii.com

REV.0
05152026
14 / 17

Please read all instructions prior to installation and keep for future reference!

1. PRODUCT TO BE INSTALLED BY A QUALIFIED ELECTRICIAN
2. USE ONLY WITH CLASS 2 POWER UNIT
3. 24 VOLTS DC
4. SUITABLE FOR DRY LOCATIONS ONLY

LED Tape Installation - After Plastering/Painting

Recommended for LED strip install with Minii Connectors. Minii connectors not available with RGB, RGBW, or Pixel LED strip

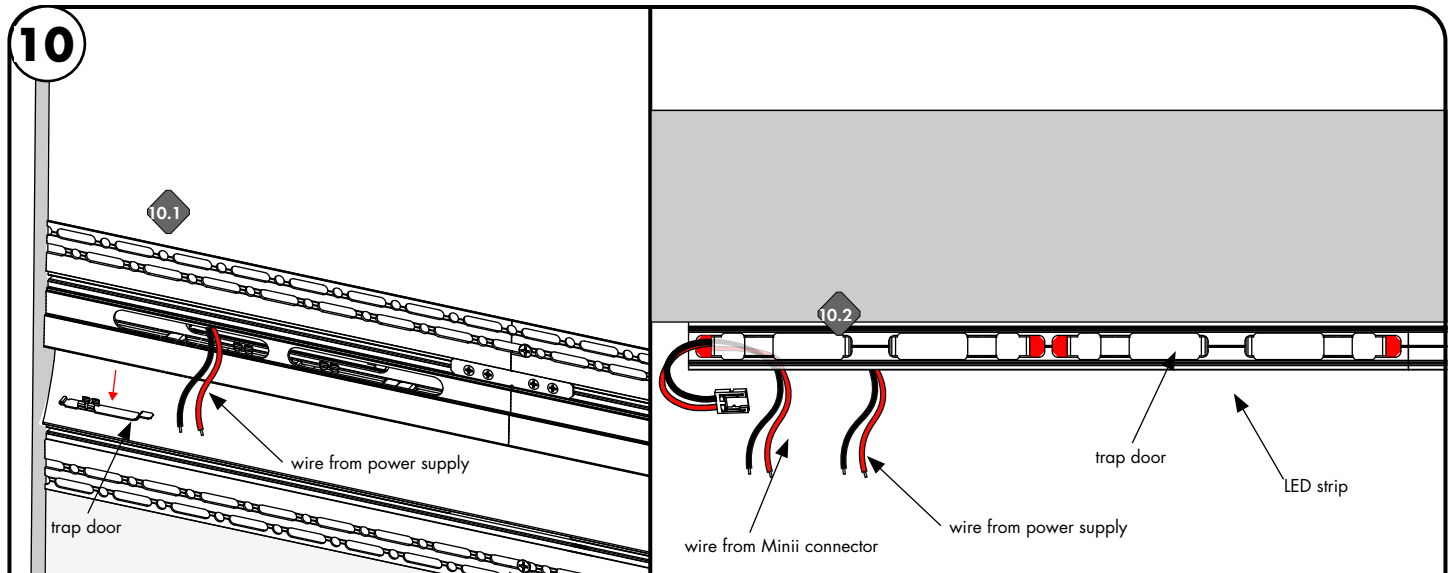

NOTE: Make sure trap doors are installed as shown.

- 10.1 Remove the trap doors. Route the wire from the LED strip through the trap door slot.
- 10.2 snap the trap door back into place. Note Symmetric orientation of trap doors. Highlighted in red is open space for LED strip wiring.

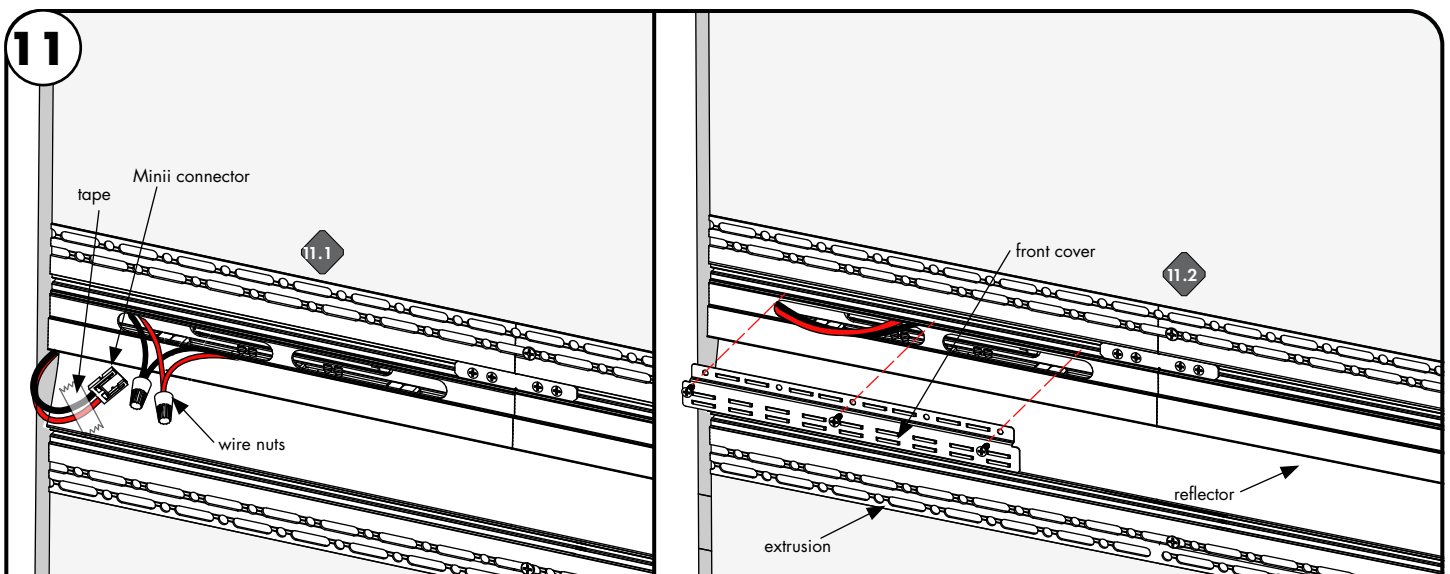

NOTE: Tape the Minii connector to the reflector.

- 11.1 Route the Minii Connector wires down through the Power Feed Section trapdoor opening and out through the front slots. Connect to the power supply wires using wire nuts/connectors. Tuck the wires through the front slots and into the Junction Box. (OPTIONAL) tape the minii connector to the reflector to keep it out of the way during plastering/painting.
- 11.2 Attach the Front Cover to the Power Feed Section using the provided screws.

Krest Reveal Installation Instructions

Krest Mud-In



7777 Merrimac Ave
Niles, IL 60714
T 224.333.6033
F 224.757.7557
info@luminii.com
www.luminii.com

REVO.0
05152026

15 / 17

Please read all instructions prior to installation and keep for future reference!

1. PRODUCT TO BE INSTALLED BY A QUALIFIED ELECTRICIAN
2. USE ONLY WITH CLASS 2 POWER UNIT
3. 24 VOLTS DC
4. SUITABLE FOR DRY LOCATIONS ONLY

LED Tape Installation - After Plastering/Painting

Recommended for LED strip install with Minii Connectors. Minii connectors not available with RGB, RGBW, or Pixel LED strip

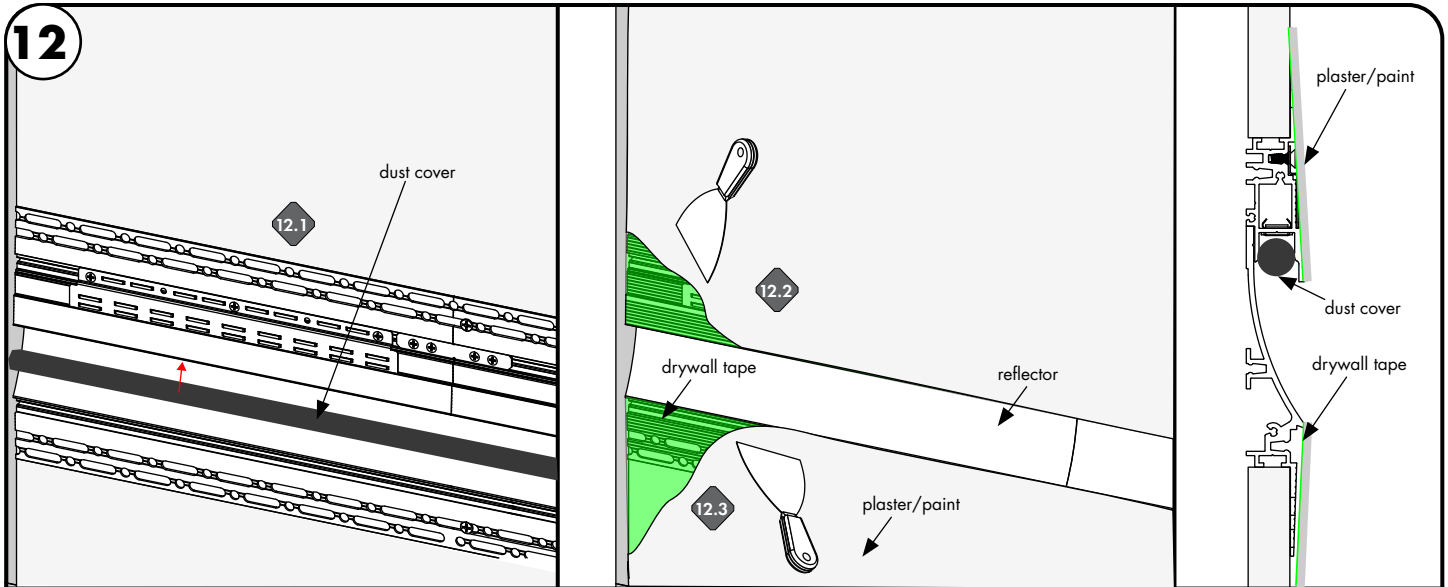

12.1 Insert the foam dust protector into the LED Extrusion channel.

12.2 Apply thin drywall tape overlapping the LED Extrusion flange and drywall. Apply plaster to the LED Extrusion, feathering 12-16" away. Multiple coats of plaster may be required to fill in the thicker cavities of the LED Extrusion and provide a smooth even surface.

12.3 Sand the plastered surface and apply paint.

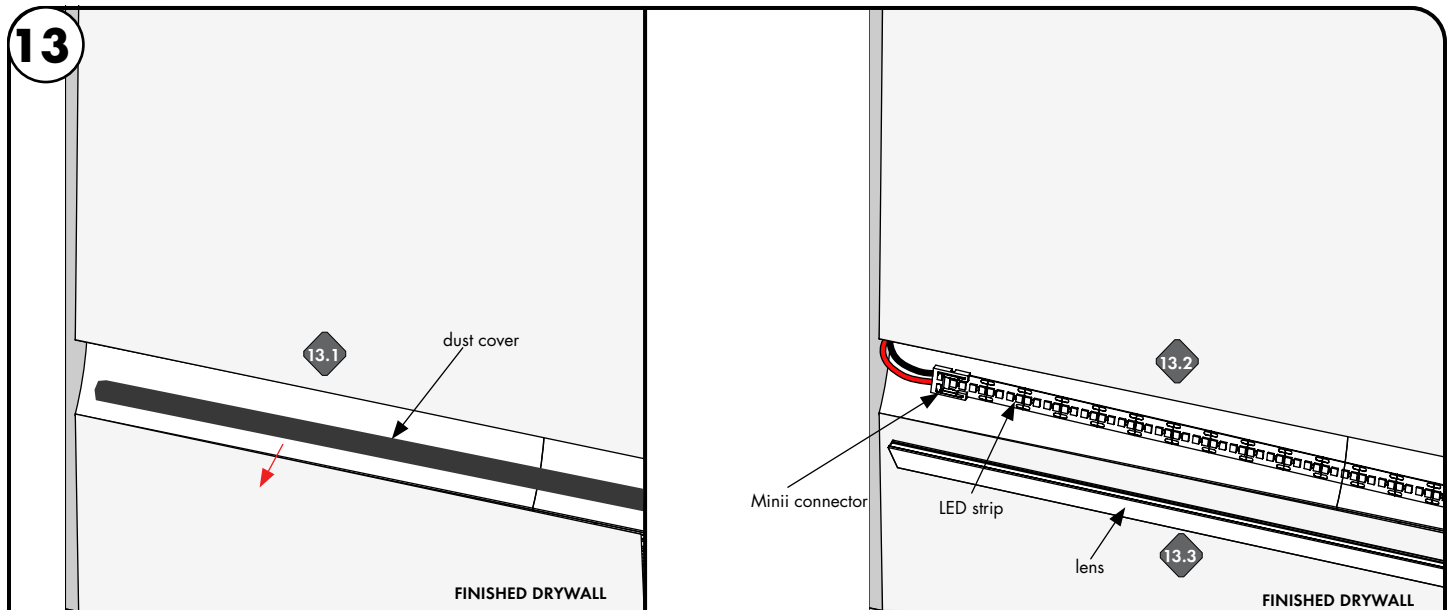

NOTE: DO NOT push the lens too far into extrusion.

13.1 Remove Foam Dust Cover. Clean any remaining dust/debris off the LED mounting surface.

13.2 Connect the LED Tape to the Minii Connector and push wires back through the trapdoor opening while affixing the LED Tape's adhesive backing to the LED Extrusion. See QR code on following page for detailed steps on connecting LED strip to minii connector. LED strip will rest on top of the trap door covers.

13.3 Snap in the Lens.

Krest Reveal Installation Instructions

Krest Mud-In



7777 Merrimac Ave
Niles, IL 60714
T 224.333.6033
F 224.757.7557
info@luminii.com
www.luminii.com

REVO.0
05152026

16 / 17

Please read all instructions prior to installation and keep for future reference!

1. PRODUCT TO BE INSTALLED BY A QUALIFIED ELECTRICIAN
2. USE ONLY WITH CLASS 2 POWER UNIT
3. 24 VOLTS DC
4. SUITABLE FOR DRY LOCATIONS ONLY

LED Tape Installation - After Plastering/Painting

Recommended for LED strip install with Minii Connectors. Minii connectors not available with RGB, RGBW, or Pixel LED strip

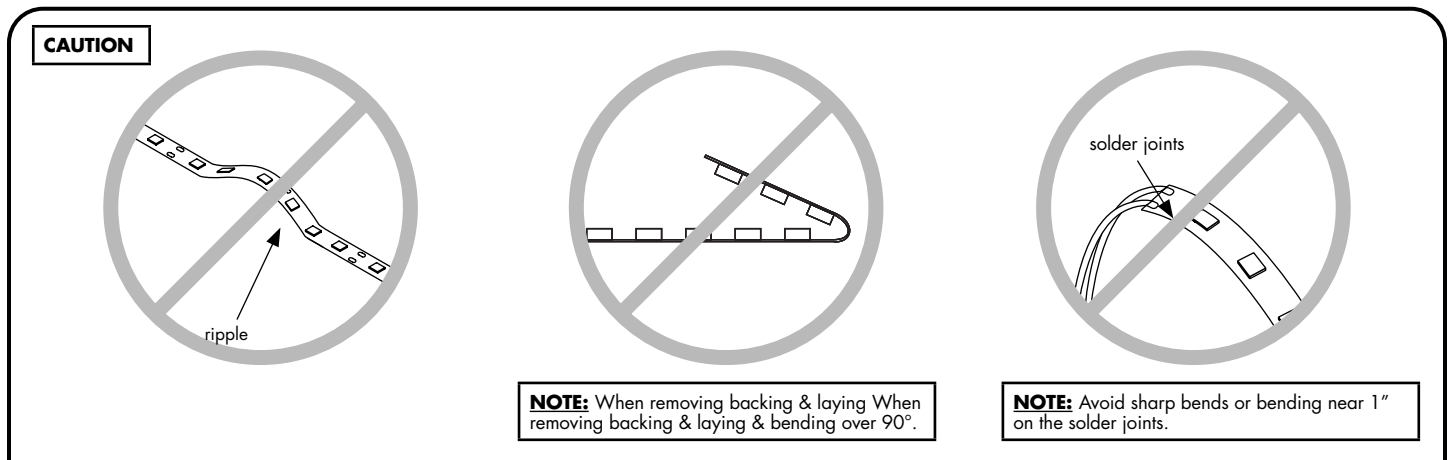
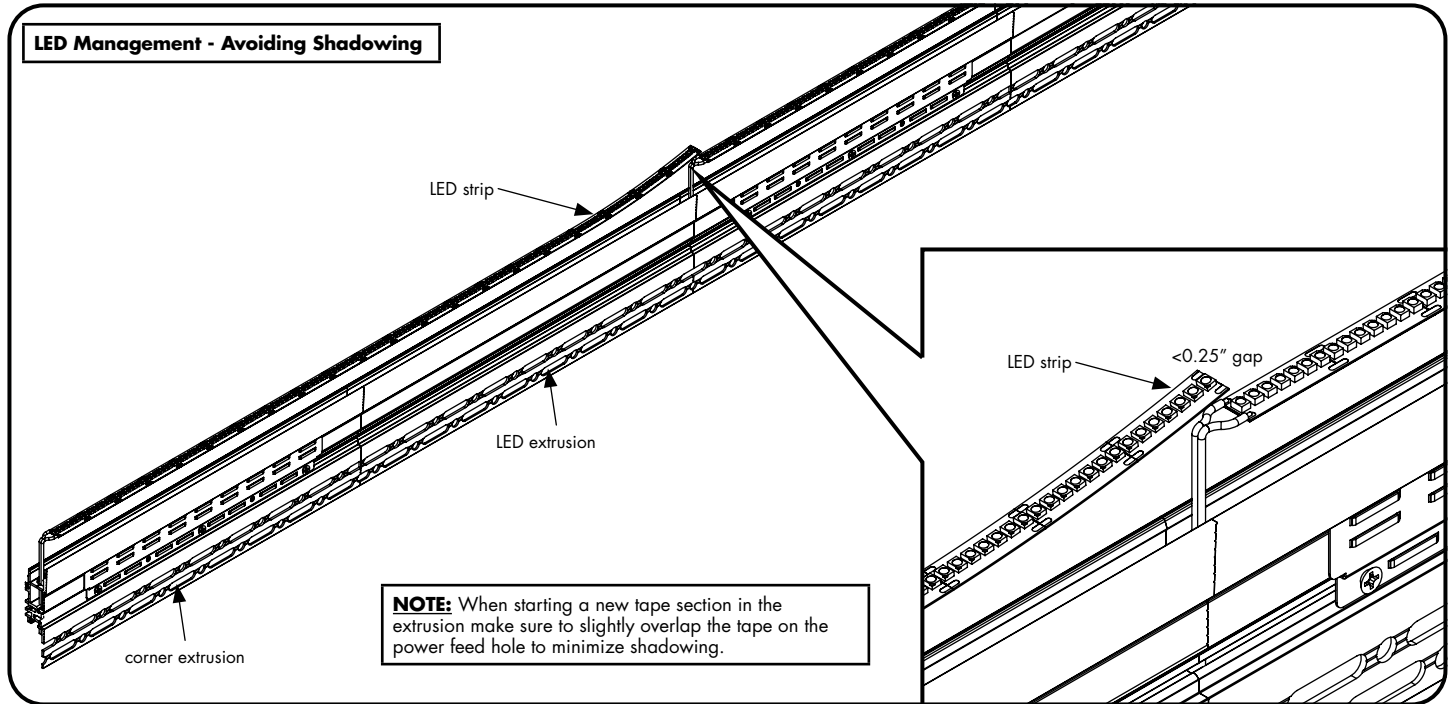

Minii Connector Installation



Scan the QR code for [Minii Connector Install Instructions](#)

Krest Reveal Installation Instructions

Krest Mud-In

Please read all instructions prior to installation and keep for future reference!

1. PRODUCT TO BE INSTALLED BY A QUALIFIED ELECTRICIAN
2. USE ONLY WITH CLASS 2 POWER UNIT
3. 24 VOLTS DC
4. SUITABLE FOR DRY LOCATIONS ONLY



REVO.0
05152026

17 / 17



7777 Merrimac Ave
Niles, IL 60714
T 224.333.6033
F 224.757.7557
info@luminii.com
www.luminii.com

Power Supply Wiring Diagram

Note: Prior to installation all 24VDC wires must be present near fixture. Refer to the power supply installation instructions for additional information.



Static White
[Wiring Diagram PDF](#)

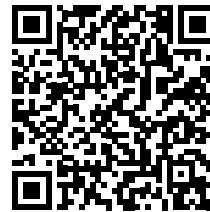

RGB/RGBW
[Wiring Diagram PDF](#)



Pixel
[Wiring Diagram PDF](#)

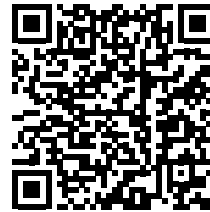

Tunable White
[Wiring Diagram PDF](#)



Warm Dim
[Wiring Diagram PDF](#)