

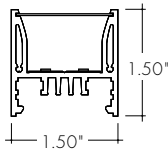

**Features**

- 24VDC Class 2 fixtures made to order up to 144". Fixtures can be linked up to 24' depending on output
- Suitable surface mount, direct view, and architectural reveal applications
- Approved for closet/storage space installation per NEC 410.16(A) (3) and 410.16(C)(5) on outputs 5.7 W/ft or less
- Class 2 listed for damp locations
- Dot free even illumination with frosted lens
- High Color Quality options offer premium quality and vibrant colors with R9 values up to 97
- High Efficacy options offer best in class output and efficacy with over 1490 lm/ft and up to 105 lm/W
- Proprietary strong bond solder method handles up to 50 lbs of pull force on wire leads and connectors
- Average Life (L70): 50,000hrs
- 7 year warranty



**Finish Options (see page 4 for additional information)**

- Base  Silver Anodized
- 
- Powder Coat  Black  Bronze  White
- 
- Premium  Matte Black  Warm Nickel  Aged Brass  Polished Gold  Chrome



**Technical Information**

MODEL	High Color Quality			High Efficacy				High Efficacy
OUTPUT OPTIONS	2x 7250	2x 72HO	2x 72VHO	2x HE48LO	2x HE48SO	2x HE48MO	2x HE48HO	2x HE64VHO
Lumens Output (3000K) <small>(with a Frosted Lens)</small>	408 lm/ft	663 lm/ft	806 lm/ft	397 lm/ft	550 lm/ft	735 lm/ft	1179 lm/ft	1492 lm/ft
Average Power Consumption <small>(for a 4' section)</small>	5.6 W/ft	9.6 W/ft	12 W/ft	3.8 W/ft	5.6 W/ft	7 W/ft	13 W/ft	15 W/ft
Efficacy	73 lm/W	69 lm/W	67 lm/W	104 lm/W	98 lm/W	105 lm/W	91 lm/W	99 lm/W
Max Run Length <small>(in series)</small>	20 ft	16 ft	11 ft	24 ft	21 ft	17 ft	12 ft	8 ft
Ambient Operating Temperature Range*	-5°F - 125°F <small>(-20°C - 50°C)</small>			-5°F - 125°F <small>(-20°C - 50°C)</small>				-5°F - 125°F <small>(-20°C - 50°C)</small>

\*Ambient Operating Temperature Range to maintain L70 of 50k+ hours in normal mounting conditions for the fixture. Exceeding Ambient Operating Temperature Range may result in decreased life/output. Consult Technical Support for specific inquiries.

**High Color Quality (72)**

CCT	Multiplier <small>(reference - 3000K)</small>	TM-30			
		CRI	R <sub>f</sub>	R <sub>g</sub>	R <sub>9</sub>
1900K	0.55	96	94	97	90
2200K	0.70	96	95	101	89
2400K	0.72	98	97	101	91
2700K	0.74	97	96	101	91
3000K	1.00	97	95	104	97
3500K	1.02	97	94	105	97
4100K	1.07	97	90	99	97

**High Efficacy (HE48/HE64)**

CCT	Multiplier <small>(reference - 3000K)</small>	TM-30			
		CRI	R <sub>f</sub>	R <sub>g</sub>	R <sub>9</sub>
2200K	0.73	92	91	97	42
2500K	0.81	93	96	96	62
2700K	0.94	92	90	99	58
3000K	1.00	92	89	99	57
3500K	1.02	92	89	99	60
4000K	1.02	92	86	94	71

**Ordering Code**

MODEL	LENGTH <sup>1</sup>	OUTPUT <sup>2</sup>	CCT	LENS <sup>3</sup>	MOUNTING	FINISH <sup>4</sup>	LEFT END CAP <sup>6</sup>	RIGHT END CAP <sup>6</sup>	POWER FEED LEFT END <sup>7</sup>	POWER FEED RIGHT END <sup>7</sup>
K-Kilo	12"-144" 1" increments	7250-Standard 72HO-High 72VHO-Very High	19K-1900K	F-Frosted C-Clear N-No Lens	CB-Concealed Bracket A-Adjustable Hinge Bracket, up to 90° <sup>6</sup>	BASE SA-Silver Anodized	LE-Endcap Left End	RE-Endcap Right End RN-No Endcap Right End	LWE-End Wire Leads LFE-End Female Q/C	RNPF-No Power Feed
			22K-2200K 24K-2400K 27K-2700K 30K-3000K 35K-3500K 41K-4100K			POWDER COAT BK-Black BZ-Bronze WH-White	LE-Endcap Left End LN-No Endcap Left End	RE-Endcap Right End RN-No Endcap Right End	LWB-Back Wire Leads LFB-Back Female Q/C	RNPF-No Power Feed
			HE48LO-Low HE48SO-Standard HE48MO-Medium HE48HO-High HE64VHO-Very High			PREMIUM MBK-Matte Black WN-Warm Nickel AB-Aged Brass PG-Polished Gold <sup>5</sup> CH-Chrome <sup>5</sup>	LE-Endcap Left End LN-No Endcap Left End	RE-Endcap Right End RN-No Endcap Right End	LNPf-No Power Feed	RWE-End Wire Leads RFE-End Female Q/C
	12"-144" 2" increments		22K-2200K 25K-2500K 27K-2700K 30K-3000K 35K-3500K 40K-4000K				LE-Endcap Left End LN-No Endcap Left End	RE-Endcap Right End RN-No Endcap Right End	LNPf-No Power Feed	RWB-Back Wire Leads RFB-Back Female Q/C

1 - Custom lengths and increments are available, please consult Inside Sales with specific request.  
 2 - All High Efficacy options can be used to comply with Title 24 JAB. High Color Quality options can be used to comply with Title 24 JAB depending on Output, CCT, and Lens selections. See multiplier charts to calculate specific efficacies.  
 3 - Continuous lens may be ordered separately for multi-fixture runs to create an even, seamless appearance.  
 4 - Non Base finishes may have extended lead times. Custom RALs are available, please consult Inside Sales with specific request.  
 5 - Polished Gold finishes and Chrome finishes have a maximum fixture length of 96".  
 6 - End caps will have a hole for the wire feed if End Wire Leads are chosen for Power Feed.  
 7 - Wire leads are 72" long.  
 8 - NOTE: Each Kilo Surface fixture/section requires it's own home run to a power supply. They cannot be electrically connected together.

Kilo Surface Corner Options

**K-FC**  
Flat Corner

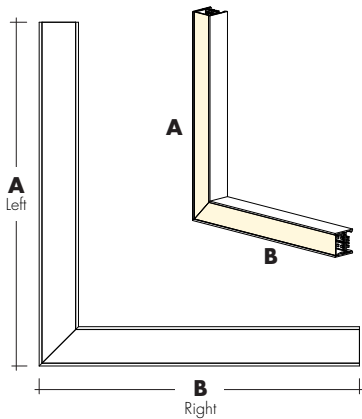

**K-IC**  
Inner Corner

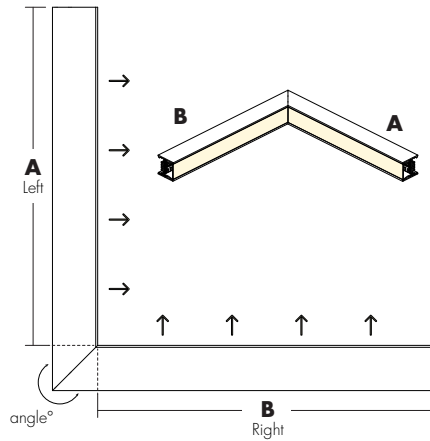

**K-OC**  
Outside Corner

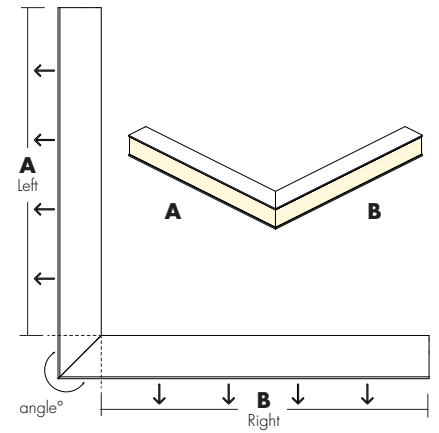

High Color Quality	Actual Length		Total Wattage		
	A	B	72SO	72HO	72VHO
Flat (K-FC)	13	11 15/16	10.2	17.1	22.6
Outer (K-OC)	11 1/16	11 1/16	10.2	17.1	22.6
Inner (K-IC)	12 5/16	12 5/16	10.2	17.1	22.6

High Efficacy	Actual Length		Total Wattage				Actual Length		Total Wattage	
	A	B	HE48LO	HE48SO	HE48MO	HE48HO	A	B	HE64SO	HE64HO
Flat (K-FC)	13 3/16	12 3/16	6.7	10.2	12.6	23.9	13 8/16	12 8/16	29.5	37.6
Outer (K-OC)	11 5/16	11 5/16	6.7	10.2	12.6	23.9	11 10/16	11 10/16	29.5	37.6
Inner (K-IC)	12 9/16	12 9/16	6.7	10.2	12.6	23.9	12 14/16	12 14/16	29.5	37.6

Ordering Code

MODEL	CORNER	ANGLE <sup>1</sup>	OUTPUT <sup>2</sup>	CCT	LENS <sup>3</sup>	MOUNTING	FINISH <sup>4</sup>	LEFT END CAP <sup>5</sup> (A)	RIGHT END CAP <sup>5</sup> (B)	POWER FEED LEFT END <sup>7</sup>	POWER FEED RIGHT END <sup>7</sup>
K - Kilo	IC - Inside Corner OC - Outside Corner FC - Flat Corner	90-90° C - Custom Angle Corner <sup>1</sup>	72SO - Standard 72HO - High 72VHO - Very High	19K - 1900K	F - Frosted C - Clear N - None	CB - Concealed Bracket	BASE	LE - Endcap Left End LN - No Endcap Left End	RE - Endcap Right End RN - No Endcap Right End	LWE - End Wire Leads LFE - End Female Q/C	RNPF - No Power Feed
				22K - 2200K			SA - Silver Anodized				
				24K - 2400K			POWDER COAT				
			27K - 2700K			BK - Black			LWB - Back Wire Leads	RNPF - No Power Feed	
			30K - 3000K			BZ - Bronze			LFB - Back Female Q/C	RNPF - No Power Feed	
			35K - 3500K			WH - White				RNPF - No Power Feed	
			41K - 4100K							RNPF - No Power Feed	
			HE48LO - Low	22K - 2200K			PREMIUM			LNPF - No Power Feed	RWE - End Wire Leads
			HE48SO - Standard	25K - 2500K			MBK - Matte Black			LNPF - No Power Feed	RFE - End Female Q/C
			HE48MO - Medium	27K - 2700K			WN - Warm Nickel			LNPF - No Power Feed	RFE - End Female Q/C
			HE48HO - High	30K - 3000K			AB - Aged Brass			LNPF - No Power Feed	RWB - Back Wire Leads
			HE64VHO - Very High	35K - 3500K			PG - Polished Gold <sup>5</sup>			LNPF - No Power Feed	RFB - Back Female Q/C
				40K - 4000K			CH - Chrome <sup>5</sup>			LNPF - No Power Feed	RFB - Back Female Q/C

1 - Custom Angle Corners are available, please consult Inside Sales with specific request.  
 2 - All High Efficacy options can be used to comply with Title 24 JAB. High Color Quality options can be used to comply with Title 24 JAB depending on Output, CCT, and Lens selections. See multiplier charts to calculate specific efficacies.  
 3 - Continuous Lens may be ordered separately for multi-fixture runs to create an even, seamless appearance.

4 - Non Base finishes may have extended lead times. Custom RALs are available, please consult Inside Sales with specific request.  
 5 - Polished Gold finishes and Chrome finishes have a maximum fixture length of 96".  
 6 - End caps will have a hole for the wire feed if End Wire Leads are chosen for Power Feed.  
 7 - Wire leads are 72" long.  
 8 - NOTE: Each Kilo Surface fixture/section requires it's own home run to a power supply. They cannot be electrically connected together

**Powerfeed options for Continuous Run Straight Fixtures**

**START FIXTURE (LEFT ENDCAP)**

Wire leads/Female Q/C on Left End of Fixture

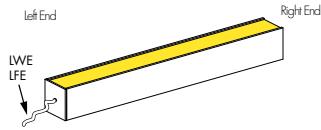

**MIDDLE FIXTURE (NO ENDCAPS)**

Wire leads/Female Q/C on Left or Right Back of Fixture

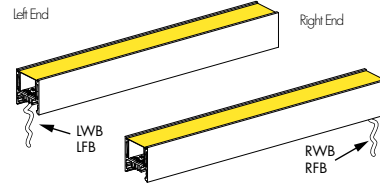

**END FIXTURE (RIGHT ENDCAP)**

Wire leads/Female Q/C on Right End of Fixture

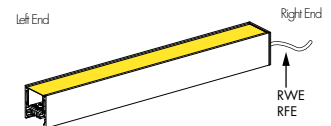

**START FIXTURE (LEFT ENDCAP)**

Wire leads/Female Q/C on Left or Right Back of Fixture

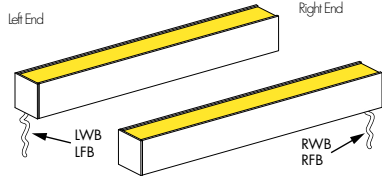

**END FIXTURE (RIGHT ENDCAP)**

Wire leads/Female Q/C on Left/Right Back of Fixture

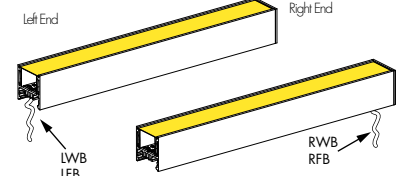

**Powerfeed options for Single Straight Fixtures**

**SINGLE FIXTURE (TWO ENDCAPS)**

Wire leads/Female Q/C on Left or Right End of Fixture

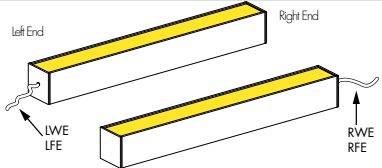

**SINGLE FIXTURE (TWO ENDCAPS)**

Wire leads/Female Q/C on Left or Right Back of Fixture

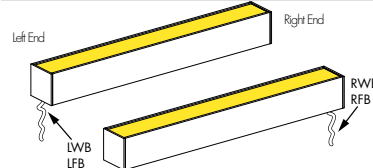

**Powerfeed options for Corner Fixtures**

**KR-FC-90-XX-LNPF-RXX**

Wire Leads or Female Quick Connect on Power Feed Right End/Back of Flat Corner

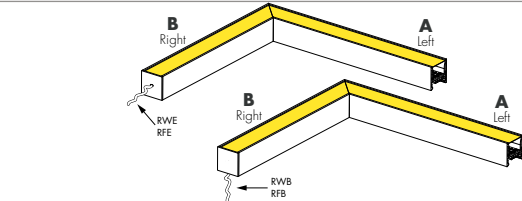

Note: Back Wire Feed also available on Power Feed Left End (A), but not shown

**KR-FC-90-XX-LXX-RNPF**

Wire Leads or Female Quick Connect on Power Feed Left End/Back of Flat Corner

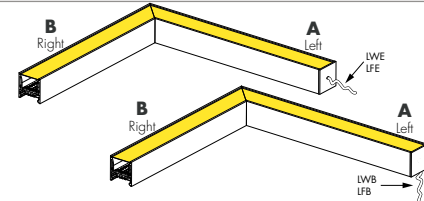

Note: Back Wire Feed also available on Power Feed Right End (B), but not shown

**KR-IC-90-XX-LNPF-RXX**

Wire Leads or Female Quick Connect on Power Feed Right End/Back of Inside Corner

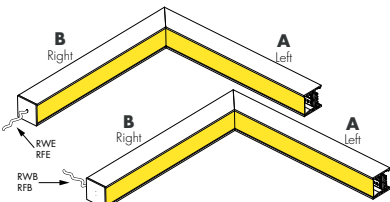

Note: Back Wire Feed also available on Power Feed Left End (A), but not shown

**KR-IC-90-XX-LXX-RNPF**

Wire Leads or Female Quick Connect on Power Feed Left End/Back of Inside Corner

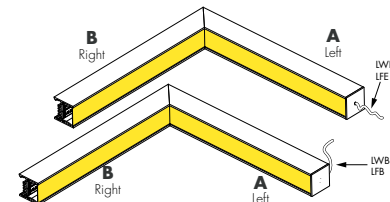

Note: Back Wire Feed also available on Power Feed Right End (B), but not shown

**KR-OC-90-XX-LNPF-RXX**

Wire Leads or Female Quick Connect on Power Feed Right End/Back of Outside Corner

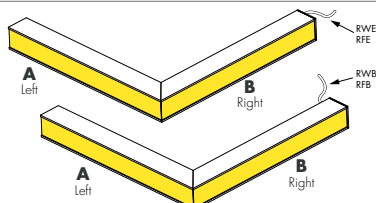

Note: Back Wire Feed also available on Power Feed Left End (A), but not shown

**KR-OC-90-XX-LXX-RNPF**

Wire Leads or Female Quick Connect on Power Feed Left End/Back of Outside Corner

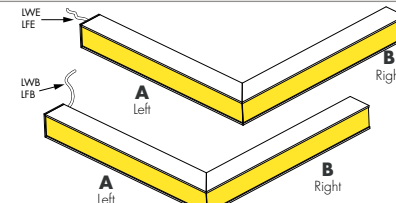

Note: Back Wire Feed also available on Power Feed Right End (B), but not shown

**Product Dimensions**

CB  
Concealed Bracket

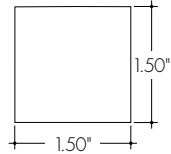
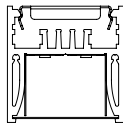

Left Side

Right Side

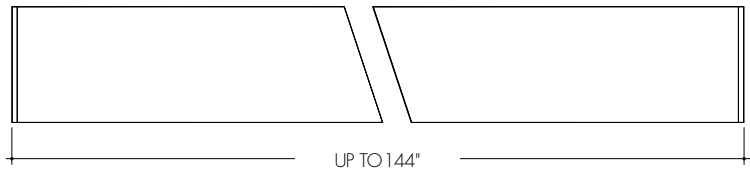

A  
Adjustable Hinge  
Mounting Bracket

Back cover plate on  
adjustable hinge  
mounting only

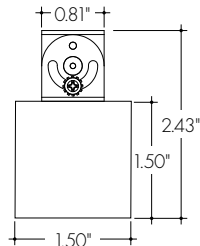
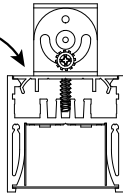

Left Side

Right Side

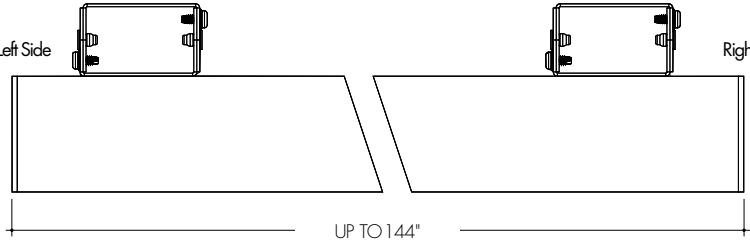

Adjustable Hinge Mounting Bracket is not available on system runs with corners

**Finish Options**

- Finish options are available in a wide variety, allowing for complete customization of style and aesthetic.
- Non Base finishes may have extended lead times and price adder.
- Polished Gold and Chrome finishes have a maximum fixture length of 96".
- Custom RALs are available, please consult Inside Sales with specific request.

**Silver Anodized  
Base**

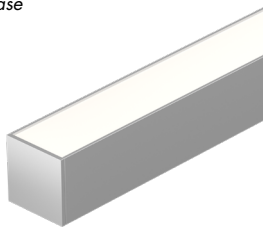

Silver Anodized is a soft silver with a clear finish.

**Black  
Powder Coat**

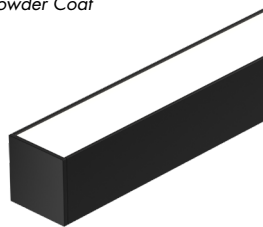

Black is a true deep black with a glossy finish.

**Bronze  
Powder Coat**

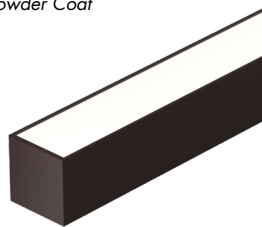

Bronze is a rich, dark brown with a satin finish.

**White  
Powder Coat**

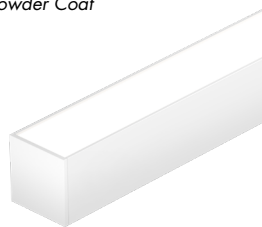

White is a polar bright white and field paintable.

**Matte Black  
Premium**

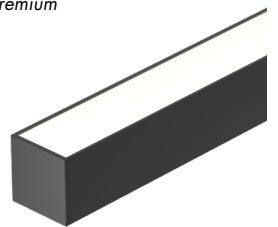

Matte Black is a dark, pitch-black with a soft flat finish.

**Warm Nickel  
Premium**

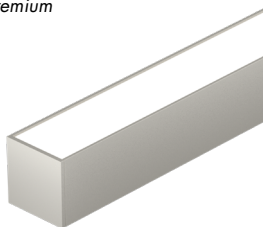

Warm Nickel is a soft, silvery smoke with warm tones and a satin finish.

**Aged Brass  
Premium**

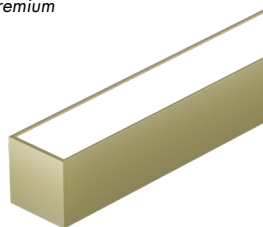

Aged Brass is a deep brown shade with slightly golden undertones.

**Polished Gold  
Premium**

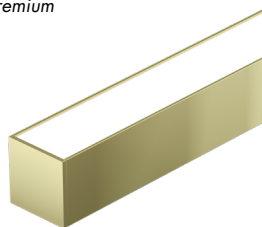

Polished Gold is bright and radiant for a brilliant finish.

**Chrome  
Premium**

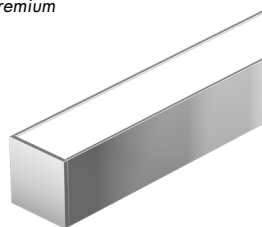

Chrome is a highly reflective silver polish.

Accessory Options

Continuous Lens (Field Cuttable)

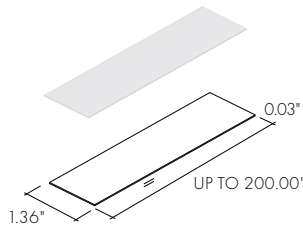

**KILO-FF** - Kilo Channel Continuous Frosted Lens  
**KILO-CC** - Kilo Channel Continuous Clear Lens

**XX** - Order in 10' increments up to 200'

**Note:** Order the continuous (field cuttable) lens up to 200'. Recommended to avoid seams between multiple fixtures joining together.

**LVSP-4T-BK**

Low Voltage, 4 Terminal Splice Box, Black

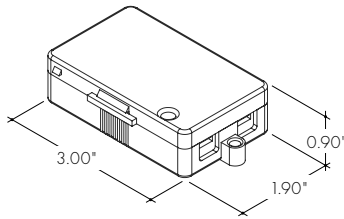

**OS-DC-F4-BK**

Occupancy Sensor

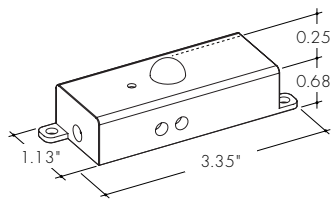

Male Quick Connect, FMA, LMC, LYC, or IS-DC are required for input and output.

**DIM-DC-F4-BK**

24VDC Low Voltage In-line Dimmer Module

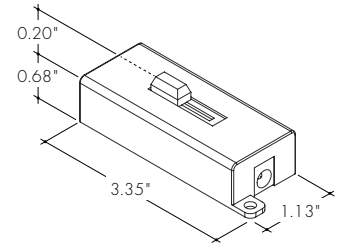

Male Quick Connect, FMA, LMC, LYC, or IS-DC are required for input and output.

Powerfeeds and Connectors

Linking and Extension Cable Options

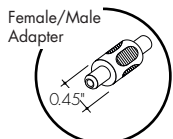
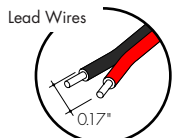
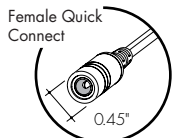
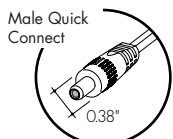

**LMC-12**

Male quick-connect, 2 pin, 12"

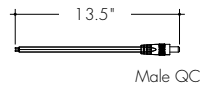

**LMC-70**

Male quick-connect long, 2 pin, 70"

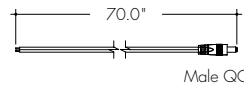

**EC-12**

Female to Female Extension Cable, 2 pin, 12"

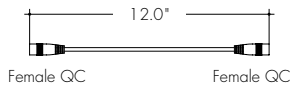

**EC-48**

Female to Female Extension Cable, 2 pin, 48"

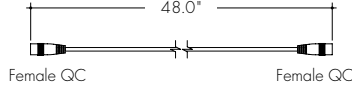

**EC-120**

Female to Female Extension Cable, 2 pin, 120"

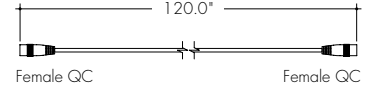

**LYC**

1 Female to 2 Male Splitter Cable, 2 pin, 12"

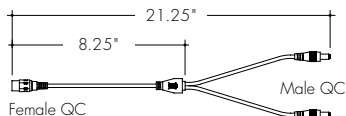

**FMA**

Female to male adapter

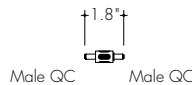

**IS-DC**

Male to Female Inline DC Switch, 2 pin, 12"

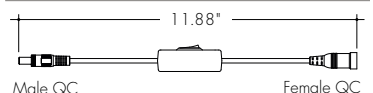

Sample Layout of Power Feed

**K-XX-LE-RN-LWE-RNPF**

End cap left end, no end cap right end of Fixture  
Wire leads on the left end of Fixture

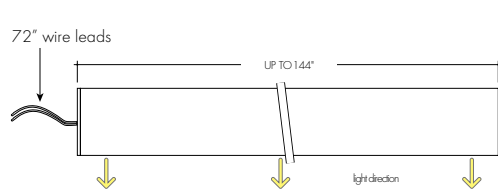

**K-XX-LN-RN-LWB-RNPF**

No end cap on left or right end of Fixture  
Wire leads on the left backside of Fixture

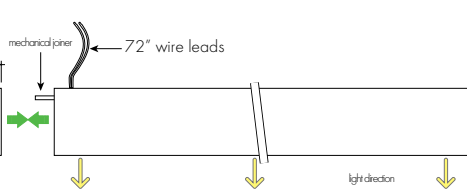

**K-XX-LN-RE-LNPF-RFB**

No end cap left end, end cap right end of Fixture  
Female Q/C on the right backside of Fixture

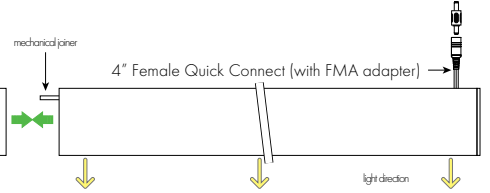

**NOTE:** Kilo Surface sections are not joined electrically. Each Kilo Surface section requires its own home run to the power supply. Mechanical joiners are included for every missing LEFT end cap (LN)

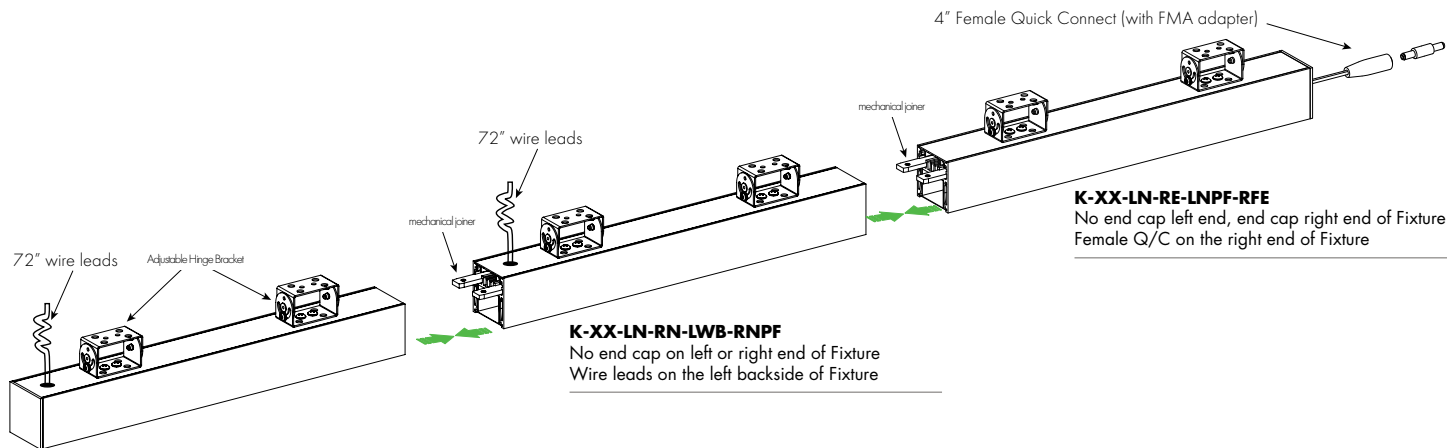

**K-XX-LE-RN-LWB-RNPF**

End cap left end, no end cap right end of Fixture  
Wire leads on the left backside of Fixture

**K-XX-LN-RE-LNPF-RFE**

No end cap left end, end cap right end of Fixture  
Female Q/C on the right end of Fixture

**NOTE:** Kilo Surface sections are not joined electrically. Each Kilo Surface section requires its own home run to the power supply. Adjustable hinge mounting brackets are not compatible with corners, or system runs that have corner sections in them.

Layout Example

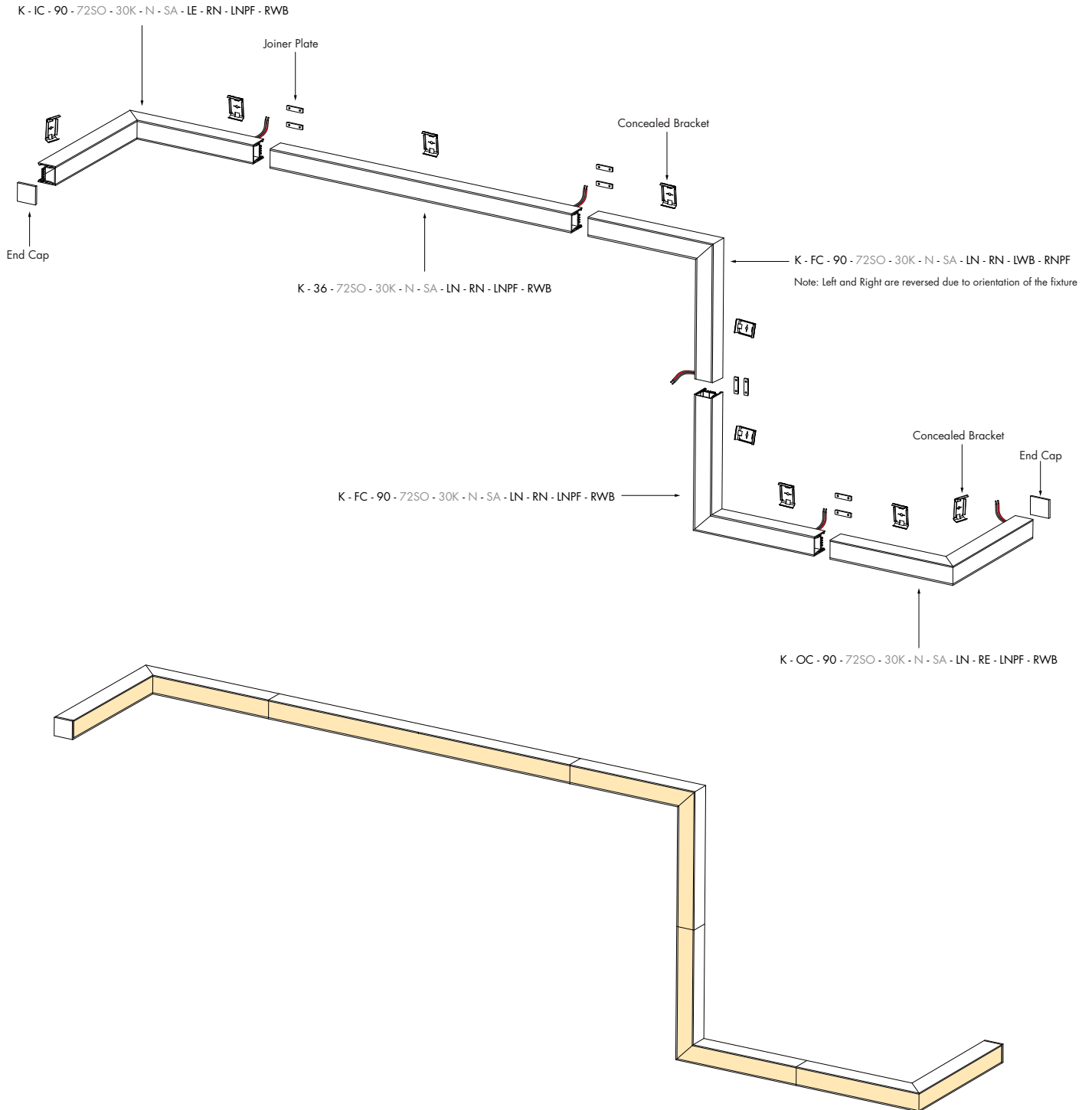

Light Transmission and Dotting

Output Options	Lens/Accessory							
	Clear Lens				Frosted Lens			
Dimming Level	100%	50%	10%	1%	100%	50%	10%	1%
72SO	CD	CD	CD	CD	ND	ND	ND	ND
72HO	CD	CD	CD	CD	ND	ND	ND	ND
72VHO	CD	CD	CD	CD	ND	ND	ND	ND
HE48LO	CD	CD	CD	CD	ND	ND	ND	ND
HE48SO	CD	CD	CD	CD	ND	ND	ND	ND
HE48MO	CD	CD	CD	CD	ND	ND	ND	ND
HE48HO	CD	CD	CD	CD	ND	ND	ND	ND
HE64VHO	CD	CD	CD	CD	ND	ND	ND	ND
<b>Transmission Percentage</b>	114%				100%			

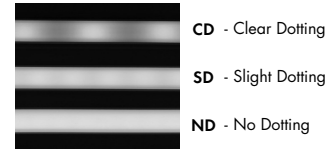

Photometry

K-48-72VHO-30K-C

Kilo, 4ft, 72VHO, 3000K, Clear Lens

Zonal Lumen Summary 3000K

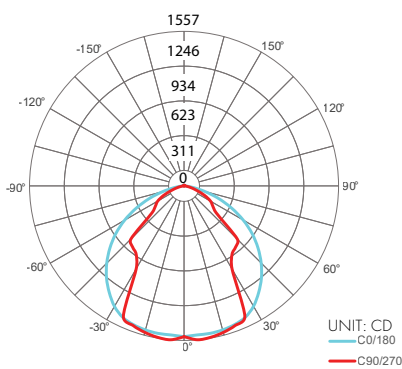

Zone	Lumen	% Fixture
0-30	1224	33.4%
0-40	1930	52.7%
0-60	3125	85.3%
0-90	3635	99.2%
0-180	3664	100%

Total

K-48-72VHO-30K-F

Kilo, 4ft, 72VHO, 3000K, Frosted Lens

Zonal Lumen Summary 3000K

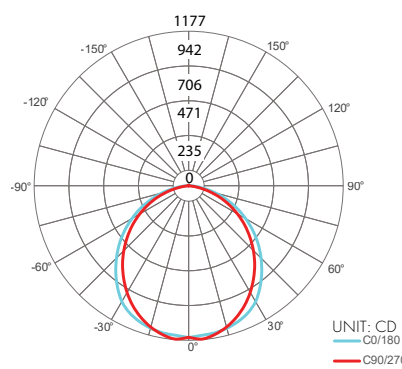

Zone	Lumen	% Fixture
0-30	895	27.8%
0-40	1459	45.3%
0-60	2552	79.2%
0-90	3196	99.2%
0-180	3223	100%

Total



**Power Consumption**

Tested at Full Power with PS-UNI Series power supplies.

\*For Back Feed add 4/16" (1/4") to Actual Length. Standard Nominal Lengths offered provide minimal shadowing. For alternate lengths, please consult Inside Sales with specific request.

**High Color Quality (2x 72)**

Nominal Length (in)	End Feed Actual Length*	Watts			Nominal Length (in)	End Feed Actual Length*	Watts			Nominal Length (in)	End Feed Actual Length*	Watts			Nominal Length (in)	End Feed Actual Length*	Watts		
		SO	HO	VHO			SO	HO	VHO			SO	HO	VHO			SO	HO	VHO
12	12	5.3	9.0	12.1	47	46 12/16	21.1	33.6	43.1	82	81 7/16	34.5	53.3	68.2	117	116 3/16	47.2	69.9	88.1
13	-	-	-	-	48	47 14/16	21.5	34.2	43.8	83	82 10/16	34.8	53.9	69.4	118	117 6/16	47.5	70.4	88.6
14	13 2/16	5.8	9.8	13.1	49	-	-	-	-	84	83 13/16	35.4	54.6	71.4	119	118 8/16	47.8	70.8	89.1
15	14 5/16	6.5	10.9	14.5	50	49 1/16	22.0	34.9	44.6	85	84 15/16	35.7	55.1	72.2	120	119 11/16	48.3	71.5	89.8
16	15 7/16	6.9	11.6	15.5	51	50 3/16	22.5	35.9	45.9	86	-	-	-	-	121	120 13/16	48.6	71.9	90.2
17	16 10/16	7.3	12.3	16.5	52	51 6/16	22.9	36.5	46.7	87	86 2/16	36.1	55.6	72.7	122	122	48.8	72.4	90.6
18	17 12/16	8.0	13.4	17.9	53	52 8/16	23.3	37.1	47.5	88	87 4/16	36.7	56.4	73.3	123	-	-	-	-
19	18 15/16	8.4	14.2	18.9	54	53 11/16	23.9	38.1	48.8	89	88 7/16	37.1	56.9	73.7	124	123 2/16	49.0	72.9	91.0
20	-	-	-	-	55	54 13/16	24.3	38.7	49.6	90	89 9/16	37.5	57.3	74.2	125	124 5/16	49.4	73.6	91.7
21	20 2/16	8.9	14.9	19.8	56	56	24.8	39.3	50.4	91	90 12/16	38.1	58.1	74.9	126	125 7/16	49.6	74.0	92.1
22	21 4/16	9.6	16.0	21.2	57	-	-	-	-	92	91 14/16	38.5	58.7	75.6	127	126 10/16	49.8	74.5	92.5
23	22 7/16	10.0	16.7	22.1	58	57 2/16	25.2	39.9	51.2	93	-	-	-	-	128	127 13/16	50.2	74.9	93.3
24	23 9/16	10.5	17.4	23.1	59	58 5/16	25.9	40.8	52.4	94	93 1/16	38.9	59.4	76.3	129	128 15/16	50.5	75.2	93.8
25	24 12/16	11.1	18.6	24.4	60	59 7/16	26.3	41.4	53.2	95	94 3/16	39.6	60.3	77.3	130	-	-	-	-
26	25 14/16	11.6	19.3	25.3	61	60 10/16	26.7	42.0	54.0	96	95 6/16	40.0	60.9	78.0	131	130 2/16	50.8	75.5	94.3
27	-	-	-	-	62	61 12/16	27.3	42.9	55.0	97	96 8/16	40.4	61.5	78.7	132	131 4/16	51.2	75.9	95.1
28	27 1/16	12.1	20.1	26.1	63	62 15/16	27.7	43.4	55.7	98	97 11/16	40.9	62.1	79.1	133	132 7/16	51.5	76.2	95.6
29	28 3/16	12.8	21.3	27.4	64	-	-	-	-	99	98 13/16	41.2	62.5	79.3	134	133 9/16	51.7	76.5	-
30	29 6/16	13.3	22.0	28.3	65	64 2/16	28.1	43.9	56.4	100	100	41.6	62.8	79.5	135	134 12/16	52.0	77.0	-
31	30 8/16	13.8	22.8	29.1	66	65 4/16	28.7	44.7	57.4	101	-	-	-	-	136	135 14/16	52.1	77.3	-
32	31 11/16	14.5	23.8	30.5	67	66 7/16	29.1	45.3	58.1	102	101 2/16	41.9	63.2	79.8	137	-	-	-	-
33	32 13/16	14.9	24.4	31.4	68	67 9/16	29.5	45.7	58.7	103	102 5/16	42.4	63.8	80.1	138	137 1/16	52.3	77.6	-
34	34	15.3	25.0	32.4	69	68 12/16	30.0	46.3	59.7	104	103 7/16	42.8	64.3	80.7	139	138 3/16	52.6	78.0	-
35	-	-	-	-	70	69 14/16	30.3	46.8	60.3	105	104 10/16	43.2	64.8	81.3	140	139 6/16	53.1	78.4	-
36	35 2/16	15.8	25.7	33.3	71	-	-	-	-	106	105 13/16	43.8	65.5	82.2	141	140 8/16	53.5	78.9	-
37	36 5/16	16.4	26.6	34.7	72	71 1/16	30.7	47.2	61.0	107	106 15/16	44.2	66.0	82.8	142	141 11/16	54.2	79.5	-
38	37 7/16	16.8	27.3	35.5	73	72 3/16	31.2	47.8	61.9	108	-	-	-	-	143	142 13/16	54.7	80.0	-
39	38 10/16	17.3	27.9	36.3	74	73 6/16	31.6	48.5	62.3	109	108 2/16	44.6	66.5	83.4	144	144	55.2	80.4	-
40	39 12/16	17.9	28.9	37.6	75	74 8/16	32.0	49.1	62.7	110	109 4/16	45.1	67.1	84.3					
41	40 15/16	18.3	29.5	38.4	76	75 11/16	32.5	50.1	63.3	111	110 7/16	45.4	67.5	84.9					
42	-	-	-	-	77	76 13/16	32.9	50.8	63.7	112	111 9/16	45.7	67.9	85.5					
43	42 2/16	18.7	30.1	39.2	78	78	33.3	51.4	64.1	113	112 12/16	46.1	68.4	86.3					
44	43 4/16	19.4	31.1	40.4	79	-	-	-	-	114	113 14/16	46.4	68.8	86.9					
45	44 7/16	19.9	31.8	41.1	80	79 2/16	33.6	52.0	64.9	115	-	-	-	-					
46	45 9/16	20.4	32.5	41.9	81	80 5/16	34.2	52.8	66.9	116	115 1/16	46.7	69.2	87.4					

**Power Consumption**

Tested at Full Power with PS-UNI Series power supplies.

\*For Back Feed add 4/16" (1/4") to Actual Length. Standard Nominal Lengths offered provide minimal shadowing. For alternate lengths, please consult Inside Sales with specific request.

**High Efficacy (2x HE48)**

Nominal Length (in)	End Feed Actual Length*	Watts				Nominal Length (in)	End Feed Actual Length*	Watts				Nominal Length (in)	End Feed Actual Length*	Watts				Nominal Length (in)	End Feed Actual Length*	Watts			
		LO	SO	MO	HO			LO	SO	MO	HO			LO	SO	MO	HO			LO	SO	MO	HO
12	10 4/16	3.0	4.4	5.8	11.7	47	-	-	-	-	82	81 2/16	22.4	37.9	47.1	78.1	118	116 9/16	34.3	54.2	66.8	90.6	
13	12 4/16	3.7	5.4	7.0	14.7	48	47 10/16	14.4	22.8	27.8	48.4	83	-	-	-	-	118	-	-	-	-	-	
14	-	-	-	-	-	49	-	-	-	-	84	83 1/16	22.7	38.8	48.2	79.0	119	118 8/16	35.1	55.1	67.9	91.1	
15	14 3/16	4.4	6.4	8.1	16.8	50	49 10/16	15.0	23.7	29.0	50.4	85	-	-	-	-	120	-	-	-	-	-	
16	-	-	-	-	-	51	-	-	-	-	86	85 1/16	23.0	39.7	49.3	79.9	121	120 8/16	35.8	56.0	69.0	91.5	
17	16 3/16	5.0	7.2	9.0	18.5	52	51 9/16	15.6	24.6	30.2	52.3	87	-	-	-	-	122	-	-	-	-	-	
18	-	-	-	-	-	53	-	-	-	-	88	87	23.2	40.6	50.5	80.8	123	122 7/16	36.4	57.2	69.8	92.1	
19	18 2/16	5.7	8.2	10.2	20.6	54	53 9/16	16.1	25.5	31.3	54.2	89	89	23.4	41.5	51.6	81.6	124	-	-	-	-	-
20	-	-	-	-	-	55	-	-	-	-	90	-	-	-	-	-	125	124 7/16	37.0	58.3	70.6	92.6	
21	20 2/16	6.2	9.2	11.4	22.3	56	55 8/16	16.7	26.4	32.5	56.1	91	90 15/16	23.7	42.4	52.8	82.4	126	-	-	-	-	-
22	-	-	-	-	-	57	-	-	-	-	92	-	-	-	-	-	127	126 6/16	37.7	59.4	71.4	93.1	
23	22 1/16	6.7	10.2	12.6	23.9	58	57 8/16	17.3	27.3	33.7	57.9	93	92 15/16	24.3	43.3	54.0	83.0	128	-	-	-	-	-
24	-	-	-	-	-	59	-	-	-	-	94	-	-	-	-	-	129	128 6/16	38.3	60.0	72.1	93.2	
25	24 1/16	7.1	11.2	13.9	25.4	60	59 7/16	17.8	28.1	34.9	59.6	95	94 14/16	24.9	44.3	55.3	83.6	130	-	-	-	-	-
26	-	-	-	-	-	61	-	-	-	-	96	-	-	-	-	-	131	130 5/16	38.9	60.7	72.8	93.3	
27	26	7.7	12.3	15.1	27.4	62	61 7/16	18.3	29.0	36.0	62.1	97	96 14/16	25.6	45.3	56.5	84.3	132	-	-	-	-	-
28	28	8.4	13.5	16.4	29.5	63	-	-	-	-	98	-	-	-	-	-	133	132 5/16	39.5	61.3	73.5	93.5	
29	-	-	-	-	-	64	63 6/16	18.6	29.9	37.2	65.4	99	98 13/16	26.6	46.2	57.5	84.9	134	-	-	-	-	-
30	29 15/16	9.0	14.6	17.6	31.6	65	-	-	-	-	100	-	-	-	-	-	135	134 4/16	40.1	62.4	74.2	93.8	
31	-	-	-	-	-	66	65 6/16	18.9	30.8	38.3	68.6	101	100 13/16	27.6	47.2	58.4	85.5	136	-	-	-	-	-
32	31 14/16	9.7	15.6	18.7	33.7	67	-	-	-	-	102	-	-	-	-	-	137	136 4/16	40.8	63.4	74.8	94.2	
33	-	-	-	-	-	68	67 5/16	19.3	31.8	39.4	70.7	103	102 12/16	28.5	48.1	59.4	86.2	138	-	-	-	-	-
34	33 14/16	10.4	16.5	19.8	35.7	69	-	-	-	-	104	-	-	-	-	-	139	138 3/16	41.4	64.4	75.4	94.5	
35	-	-	-	-	-	70	69 5/16	19.8	32.8	40.6	71.8	105	104 12/16	29.1	49.1	60.5	86.8	140	-	-	-	-	-
36	35 13/16	11.0	17.4	20.8	37.7	71	-	-	-	-	106	-	-	-	-	-	141	140 3/16	42.0	65.0	76.1	94.1	
37	-	-	-	-	-	72	71 4/16	20.2	33.9	41.7	72.8	107	106 11/16	29.7	50.1	61.7	87.4	142	-	-	-	-	-
38	37 13/16	11.6	18.4	22.0	39.6	73	-	-	-	-	108	-	-	-	-	-	143	142 2/16	42.5	65.4	76.5	93.7	
39	-	-	-	-	-	74	73 4/16	20.7	34.8	42.8	74.0	109	108 11/16	30.4	51.0	62.8	88.1	144	-	-	-	-	-
40	39 12/16	12.2	19.4	23.3	41.4	75	-	-	-	-	110	-	-	-	-	-	-	-	-	-	-	-	-
41	-	-	-	-	-	76	75 3/16	21.3	35.6	44.0	75.1	111	110 10/16	31.3	51.6	63.6	88.6	-	-	-	-	-	-
42	41 12/16	12.8	20.3	24.5	43.1	77	-	-	-	-	112	-	-	-	-	-	-	-	-	-	-	-	-
43	-	-	-	-	-	78	77 3/16	21.8	36.4	45.1	76.3	113	112 10/16	32.4	52.5	64.7	89.4	-	-	-	-	-	-
44	43 11/16	13.4	21.3	25.7	45.0	79	-	-	-	-	114	-	-	-	-	-	-	-	-	-	-	-	-
45	-	-	-	-	-	80	79 2/16	22.2	37.1	46.0	77.1	115	114 9/16	33.6	53.3	65.8	90.2	-	-	-	-	-	-
46	45 11/16	14.0	22.1	26.9	47.0	81	-	-	-	-	116	-	-	-	-	-	-	-	-	-	-	-	-

**Power Consumption**

Tested at Full Power with PS-UNI Series power supplies.

\*For Back Feed add 4/16" (1/4") to Actual Length. Standard Nominal Lengths offered provide minimal shadowing. For alternate lengths, please consult Inside Sales with specific request.

**High Efficacy ( 2x HE64)**

Nominal Length (in)	End Feed Actual Length*	Watts	Nominal Length (in)	End Feed Actual Length*	Watts	Nominal Length (in)	End Feed Actual Length*	Watts
		VHO			VHO			VHO
<b>12</b>	11	13.2	<b>47</b>	—	—	<b>82</b>	—	—
<b>13</b>	12 8/16	15.1	<b>48</b>	47 6/16	59.5	<b>83</b>	82 3/16	91.7
<b>14</b>	—	—	<b>49</b>	48 14/16	61.4	<b>84</b>	83 11/16	92.5
<b>15</b>	14 1/16	17.0	<b>50</b>	—	—	<b>85</b>	—	—
<b>16</b>	15 9/16	18.9	<b>51</b>	50 6/16	63.2	<b>86</b>	85 3/16	93.1
<b>17</b>	—	—	<b>52</b>	51 14/16	65.0	<b>87</b>	86 12/16	93.7
<b>18</b>	17 1/16	20.7	<b>53</b>	—	—	<b>88</b>	—	—
<b>19</b>	18 9/16	22.6	<b>54</b>	53 7/16	66.8	<b>89</b>	88 4/16	94.4
<b>20</b>	—	—	<b>55</b>	54 15/16	68.5	<b>90</b>	89 12/16	95.0
<b>21</b>	20 2/16	24.5	<b>56</b>	—	—	<b>91</b>	—	—
<b>22</b>	21 10/16	26.4	<b>57</b>	56 7/16	70.1	<b>92</b>	91 4/16	95.6
<b>23</b>	—	—	<b>58</b>	57 15/16	71.7	<b>93</b>	92 12/16	—
<b>24</b>	23 2/16	28.2	<b>59</b>	—	—	<b>94</b>	—	—
<b>25</b>	24 10/16	30.1	<b>60</b>	59 7/16	73.3	<b>95</b>	94 5/16	—
<b>26</b>	—	—	<b>61</b>	61	74.8	<b>96</b>	95 13/16	—
<b>27</b>	26 2/16	32.0	<b>62</b>	—	—	<b>97</b>	—	—
<b>28</b>	27 11/16	34.0	<b>63</b>	62 8/16	76.0	<b>98</b>	97 5/16	—
<b>29</b>	—	—	<b>64</b>	—	—	<b>99</b>	98 13/16	—
<b>30</b>	29 3/16	36.5	<b>65</b>	64	77.2	<b>100</b>	—	—
<b>31</b>	30 11/16	38.4	<b>66</b>	65 8/16	78.4	<b>101</b>	100 6/16	—
<b>32</b>	—	—	<b>67</b>	—	—	<b>102</b>	101 14/16	—
<b>33</b>	32 3/16	40.4	<b>68</b>	67 1/16	79.6	<b>103</b>	—	—
<b>34</b>	33 12/16	42.3	<b>69</b>	68 9/16	80.6	<b>104</b>	103 6/16	—
<b>35</b>	—	—	<b>70</b>	—	—	<b>105</b>	104 14/16	—
<b>36</b>	35 4/16	44.2	<b>71</b>	70 1/16	81.7	<b>106</b>	—	—
<b>37</b>	36 12/16	46.1	<b>72</b>	71 9/16	82.7	<b>107</b>	106 7/16	—
<b>38</b>	—	—	<b>73</b>	—	—	<b>108</b>	107 15/16	—
<b>39</b>	38 4/16	48.0	<b>74</b>	73 1/16	84.0	<b>109</b>	—	—
<b>40</b>	39 12/16	49.8	<b>75</b>	74 10/16	85.7	<b>110</b>	109 7/16	—
<b>41</b>	—	—	<b>76</b>	—	—	<b>111</b>	110 15/16	—
<b>42</b>	41 5/16	51.7	<b>77</b>	76 2/16	87.4	<b>112</b>	—	—
<b>43</b>	42 13/16	53.6	<b>78</b>	77 10/16	89.1	<b>113</b>	112 7/16	—
<b>44</b>	—	—	<b>79</b>	—	—	<b>114</b>	114	—
<b>45</b>	44 5/16	55.5	<b>80</b>	79 2/16	90.4	<b>115</b>	—	—
<b>46</b>	45 13/16	57.5	<b>81</b>	80 11/16	91.0	<b>116</b>	115 8/16	—

**Voltage Drop Calculator**

The below chart assumes nominal voltage of 24 Volts and a Voltage Drop Allowance of 3% through the wire

Wattage [W]	Wire Length From Power Supply to Start of Run [ft]						
	12 AWG	14 AWG	16 AWG	18 AWG	20 AWG	22 AWG	24 AWG
<b>5</b>	1088.2	684.4	430.3	270.6	170.2	107.1	67.3
<b>10</b>	544.1	342.2	215.1	135.3	85.1	53.5	33.7
<b>15</b>	362.7	228.1	143.4	90.2	56.7	35.7	22.4
<b>20</b>	272.0	171.1	107.6	67.7	42.6	26.8	16.8
<b>25</b>	217.6	136.9	86.1	54.1	34.0	21.4	13.5
<b>30</b>	181.4	114.1	71.7	45.1	28.4	17.8	11.2
<b>35</b>	155.5	97.8	61.5	38.7	24.3	15.3	9.6
<b>40</b>	136.0	85.5	53.8	33.8	21.3	13.4	8.4
<b>45</b>	120.9	76.0	47.8	30.1	18.9	11.9	7.5
<b>50</b>	108.8	68.4	43.0	27.1	17.0	10.7	6.7
<b>55</b>	98.9	62.2	39.1	24.6	15.5	9.7	6.1
<b>60</b>	90.7	57.0	35.9	22.6	14.2	8.9	5.6
<b>65</b>	83.7	52.6	33.1	20.8	13.1	8.2	5.2
<b>70</b>	77.7	48.9	30.7	19.3	12.2	7.6	4.8
<b>75</b>	72.5	45.6	28.7	18.0	11.3	7.1	4.5
<b>80</b>	68.0	42.8	26.9	16.9	10.6	6.7	4.2
<b>85</b>	64.0	40.3	25.3	15.9	10.0	6.3	4.0
<b>90</b>	60.5	38.0	23.9	15.0	9.5	5.9	3.7
<b>96</b>	56.7	35.6	22.4	14.1	8.9	5.6	3.5

### Power Supplies

See Power Supply instructions and spec sheet for wiring information. For a complete list of compatible dimmers, see Compatible Dimming Chart on the Resources page.

#### Ordering Code Universal Dimming Power Supplies 1% 120VAC - 277VAC

MODEL	INPUT CONTROL	ENVIRONMENT	WATTAGE	OUTPUT
PS-Power Supply, 120-277VAC	UNI-0-10V Dimming, Phase Dimming	D-Dry W-Wet	30-30 Watts 60-60 Watts 96-96 Watts 3x96-3x96 Watts	24-24 VDC

Compatibility: View a complete list of compatible dimmers on product page [\(Link\)](#)

0-10V - 1% dimming  
MLV/ELV/TRIAC - 1% dimming, consult dimming compatibility chart

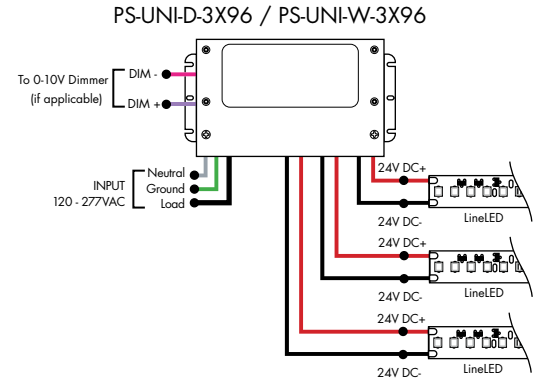
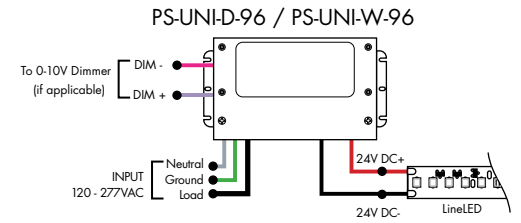

MODELS	PS-UNI-W-30W	PS-UNI-W-60W	PS-UNI-W-96W	PS-UNI-W-3X96W
Length	6.50"	7.40"	8.66"	11.85"
Width	3.73"	3.73"	3.73"	4.32"
Depth	1.61"	1.61"	1.61"	1.81"

MODELS	PS-UNI-D-30W	PS-UNI-D-60W	PS-UNI-D-96W	PS-UNI-D-3X96W
Length	8.77"	8.77"	8.11"	9.94"
Width	4.27"	4.27"	5.60"	7.61"
Depth	1.83"	1.83"	1.83"	2.02"

#### Ordering Code 0-10V Dimming Power Supplies 0.1% 120VAC - 277VAC

MODEL	INPUT CONTROL	ENVIRONMENT	WATTAGE	OUTPUT
PS-Power Supply, 120-277VAC	010V-LIN-0-10V Dimming (0.1%), Linear 010V-LOG-0-10V Dimming (0.1%), Logarithmic	D-Dry	96-96 Watts 3X96-3x96 Watts	24-24 VDC

MODELS	96W	3X96
Length	14.40"	15.00"
Width	5.20"	6.62"
Depth	2.60"	4.45"

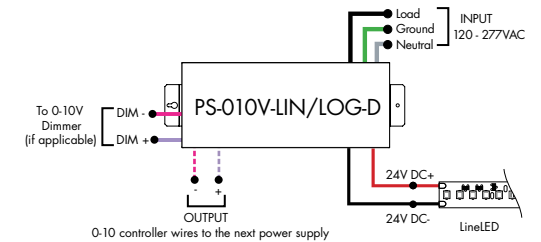
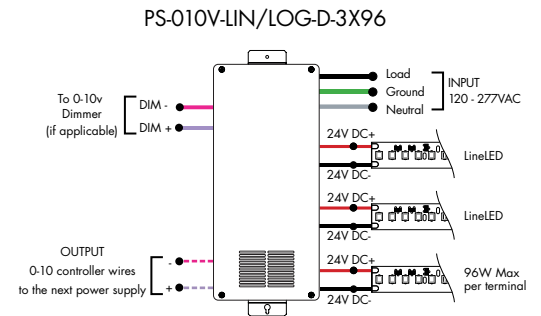

#### Athena 0-10V LED Driver

MODEL	INPUT CONTROL	ENVIRONMENT	WATTAGE	OUTPUT	FEATURE
PS-Power Supply, 120-277VAC	010V-LIN-0-10V Dimming, Linear 010V-LOG-0-10V Dimming, Logarithmic	D-Dry	96-96 W	24-24 VDC	AWNR-Athena

MODELS	96W
Length	14.40"
Width	5.20"
Depth	2.60"

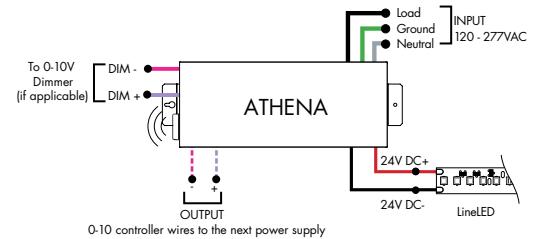

### Power Supplies

See Power Supply instructions and spec sheet for wiring information. For a complete list of compatible dimmers, see Compatible Dimming Chart on the Resources page.

#### Ordering Code DALI Dimming Power Supplies 0.1% 120VAC - 277VAC

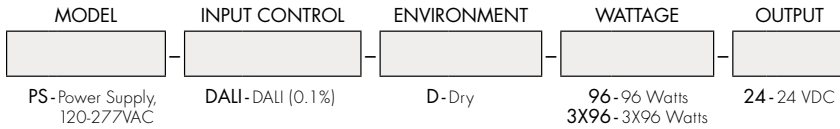

Model	96W	3X96
Length	14.40"	15.00"
Width	5.20"	6.62"
Depth	2.60"	4.56"

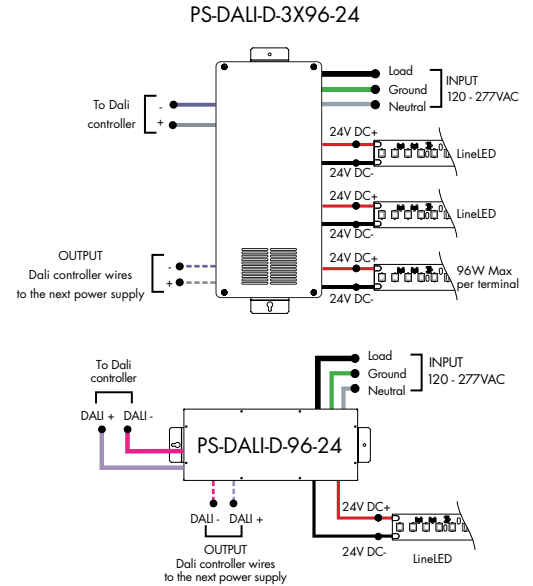

#### Ordering Code DMX Dimming Power Supplies 0.1% 120VAC - 277VAC Requires Zonal Control

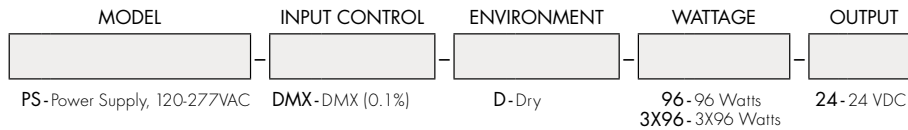

\*Zonal control power supplies. Control multiple tapes/zones using DMX channels.

MODELS	96W	3X96
Length	14.40"	15.00"
Width	5.20"	6.62"
Depth	2.60"	4.56"

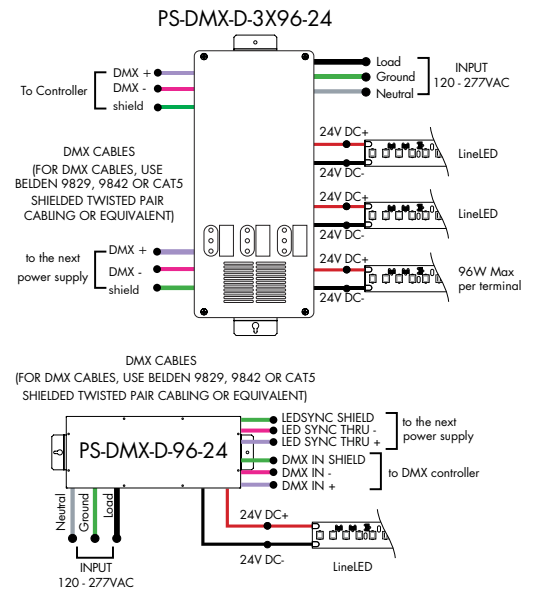

#### Ordering Code Enlightened Enabled Dimming Power Supplies 1% 120VAC - 277VAC

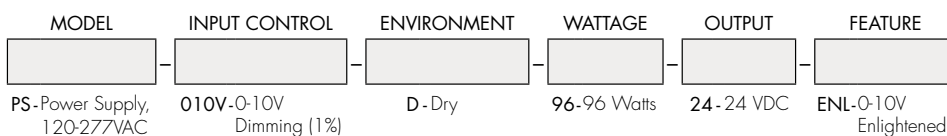

Model	96W
Length	14.40"
Width	5.20"
Depth	2.60"

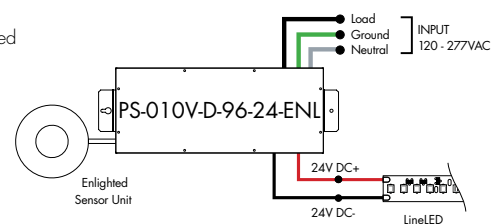

### Power Supplies

See Power Supply instructions and spec sheet for wiring information. For a complete list of compatible dimmers, see Compatible Dimming Chart on the Resources page.

#### Ordering Code Non-Dimming Power Supply 120VAC - 277VAC

MODEL	INPUT CONTROL	ENVIRONMENT	WATTAGE	OUTPUT
PS - Power Supply, 120-277VAC	ND - Non Dimming	D - Dry	96-96 Watts	24 - 24 VDC

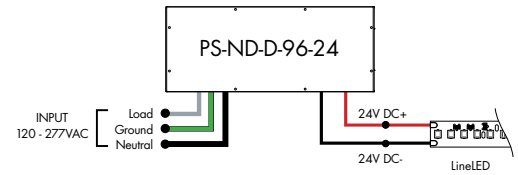

MODELS	96W
Length	14.40"
Width	5.20"
Depth	2.60"

#### Ordering Code Phase Dimming Power Supply 1% 120VAC - 277VAC

MODEL	INPUT CONTROL	ENVIRONMENT	WATTAGE	OUTPUT	OUTPUT CONTROL
PS - Power Supply, 120-277VAC	PH - Phase Dimming (Triac, ELV, MLV)	D - Dry	96 - 96 Watts	24 - 24 VDC	DC - Direct Current

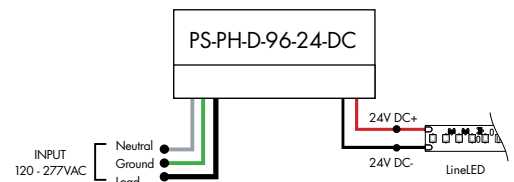

MLV/ELV/TRIAC - 1% dimming, consult dimming compatibility chart ([link](#))

NOTE:  
OVER THE WHITE, GREEN, AND BLACK WIRES,  
CONNECT TO ELV OR MLV DIMMER

MODELS	96W
Length	8.25"
Width	4.10"
Depth	1.56"

#### Ordering Code In-Ground Power Supplies

MODEL	INPUT CONTROL	ENVIRONMENT	WATTAGE	OUTPUT
PS120 - Power Supply, 120VAC PS240 - Power Supply, 240VAC PS277 - Power Supply, 277VAC	ELV - ELV Dimming (1%)	IG - In Ground	2X96 - 2X96 Watts	24 - 24 VDC

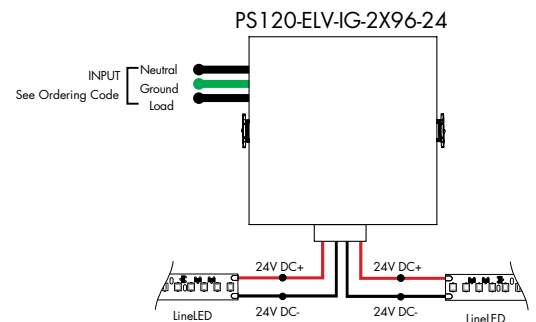

MODELS	2X96W
Length	8.40"
Width	8.30"
Depth	8.10"

### Power Supplies

See Power Supply instructions and spec sheet for wiring information. For a complete list of compatible dimmers, see Compatible Dimming Chart on the Resources page.



Luminii is a Lutron OEM Advantage Partner

**Lutron Power Supplies 1%**

MODEL

**L3DA4U1UKL-CV240**

HiLume™ 1% EcoSystem Voltage LED driver  
40W max

MODELS	L3DA4U1UKL-CV240
<b>Length</b>	4.98"
<b>Width</b>	4.00"
<b>Depth</b>	2.62"

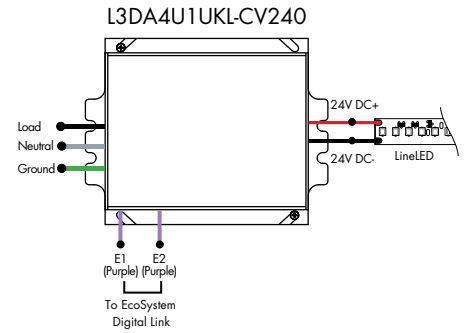

Luminii is a Lutron OEM Advantage Partner

**Lutron Power Supplies 0.1%**

MODEL

**L3D0-96W24V-U**

HiLume™ 0.1% EcoSystem Voltage LED Driver with Soft-On, Fade-to-Black™  
96W max

MODELS	L3D0
<b>Length</b>	10.50"
<b>Width</b>	5.50"
<b>Depth</b>	2.00"

