

Features

- 24VDC Class 2 fixtures made to order up to 144". Fixtures can be linked up to 16' depending on output
- Approved for closet/storage space installation per NEC 410.16(A) (3) and 410.16(C)(5) on outputs 5.7 W/ft or less
- Dot free even illumination with frosted lens
- Class two listed for damp locations
- Proprietary strong bond solder method handles up to 50 lbs of pull force on wire leads and connectors
- Average Life (L70): 50,000hrs
- 7 year warranty
- Tunable White allows individual control of CCT and output, can be paired with Vintage Dim power supply for warm dim effect
- Warm Dim follows the incandescent dimming curve and is compatible with MLV, ELV, and Incandescent dimmers.
- RGB offers balanced output across the color gamut and a true white with RGBW
- Smart Pixel allows for infinite color combinations with cascading and chasing effects

Finish Options (see page 4 for additional information)

- Base Silver Anodized
- Powder Coat Black Bronze White
- Premium Matte Black Warm Nickel Aged Brass Polished Gold Chrome



Technical Information

TYPE	Warm Dim	Tunable White		RGBW		RGB		Pixel	
OUTPUT OPTIONS	2x WD68SO (19K-27K)	2x TW68SO (27K-65K)	2x TW68HO (27K-65K)	2x RGBW36SO	2x RGBW36HO	2x RGB42SO	2x RGB42HO	2x RGBWX18SO	2x RGBX18SO
Lumens Output (all channels full on) [with a Frosted Lens]	522 lm/ft	633 lm/ft	760 lm/ft	318 lm/ft	526 lm/ft	315 lm/ft	463 lm/ft	384 lm/ft	253 lm/ft
Average Power Consumption (for a 4" section)	10.8 W/ft	9.2 W/ft	11.2 W/ft	8 W/ft	15.2 W/ft	9 W/ft	16.6 W/ft	11.4 W/ft	9 W/ft
Efficacy	48 lm/W	69 lm/W	68 lm/W	40 lm/W	35 lm/W	35 lm/W	28 lm/W	34 lm/W	28 lm/W
Max Run Length (in series)	10 ft	16 ft	16 ft	13 ft	6.5 ft	14 ft	7 ft	10 ft	15 ft
Ambient Operating Temperature Range*	-5°F - 125°F (-20°C - 50°C)	-5°F - 125°F (-20°C - 50°C)	-5°F - 125°F (-20°C - 50°C)	-5°F - 125°F (-20°C - 50°C)	-5°F - 115°F (-20°C - 45°C)	-5°F - 125°F (-20°C - 50°C)	-5°F - 105°F (-20°C - 40°C)	-5°F - 125°F (-20°C - 50°C)	
Control/Dimming Protocol	MLV, ELV, Inc.	0-10V, DMX		DMX				SPI Protocol UCS 2904	SPI Protocol UCS 2903

* Ambient Operating Temperature Range to maintain L70 of 50k+ hours in normal mounting conditions for the fixture. Exceeding Ambient Operating Temperature Range may result in decreased life/output. Consult Technical Support for specific inquiries.

Warm Dim (WD68)					Tunable White (TW68)					RGBW (3000K)					Dominant Wavelength		
CCT	CRI	TM-30			CCT	CRI	TM-30			Tape	CRI	TM-30		Color	RGB42/RGBW36	RGBX18/RGBWX18	
		R _f	R _g	R ₉			R _f	R _g	R ₉			R _f	R _g				R ₉
1900K	96	92	96	94	2700K	98	96	101	91	RGBW36	95	93	106	84	Red	620nm	621nm
2400K	97	96	103	98	2900K	98	96	102	94	RGBWX18	93	91	99	64	Green	525nm	519nm
2700K	96	93	106	95	3500K	97	94	105	97	TW68				Blue	467nm	465nm	
					4100K	95	91	104	79	CCT		Multiplier					
					4400K	97	91	101	97	27K - 65K	1.00						
					6500K	92	88	97	64	19K - 35K	0.78						

Ordering Code

MODEL	LENGTH ¹	OUTPUT ²	CCT	LENS ³	MOUNTING	FINISH ⁴	LEFT END CAP ⁵	RIGHT END CAP ⁵	POWER FEED LEFT END ⁷	POWER FEED RIGHT END ⁷
K-Kilo	12"-144" 3" increments	WD68SO-Standard	19K27K-1900K-2700K	F-Frosted C-Clear N-No Lens	CB-Concealed Bracket	BASE SA-Silver Anodized	LE-Endcap Left End	RE-Endcap Right End RN-No Endcap Right End	LWE-End Wire Leads LFE-End Female Q/C	RNPF-No Power Feed
	12"-144" 3" increments	TW68SO-Standard TW68HO-High	19K35K-1900K-3500K 27K65K-2700K-6500K			POWDER COAT BK-Black BZ-Bronze WH-White	LE-Endcap Left End LN-No Endcap Left End	RE-Endcap Right End RN-No Endcap Right End	LWB-Back Wire Leads LFB-Back Female Q/C	RNPF-No Power Feed
	12"-144" 2" increments	RGBW36SO-Standard RGBW36HO-High RGB42SO-Standard RGB42HO-High	CLR-Color			PREMIUM MBK-Matte Black WN-Warm Nickel AB-Aged Brass PG-Polished Gold ⁵ CH-Chrome ⁵	LE-Endcap Left End LN-No Endcap Left End	RE-Endcap Right End	LNPF-No Power Feed	RWE-End Wire Leads RFE-End Female Q/C
	12"-144" 4" increments	RGBWX18SO-Standard RGBX18SO-Standard	PXSPI-Smart Pixel Control				LE-Endcap Left End LN-No Endcap Left End	RE-Endcap Right End RN-No Endcap Right End	LNPF-No Power Feed	RWB-Back Wire Leads RFB-Back Female Q/C

1 - Custom lengths and increments are available, please consult Inside Sales with specific request.
 2 - Warm Dim and Tunable White options can be used to comply with Title 24 JA8 at max brightness depending on lens selection, see multiplier charts to calculate specific efficacy.
 3 - Continuous Lens may be ordered separately for multi-fixture runs to create an even, seamless appearance.
 4 - Non Base finishes may have extended lead times. Custom RALs are available, please consult Inside Sales with specific request.
 5 - Polished Gold finishes and Chrome finishes have a maximum fixture length of 96".
 6 - End caps will have a hole for the wire feed if End Wire Leads are chosen for Power Feed.
 7 - Wire leads are 72" long.
 8 - NOTE: Each Kilo Surface fixture/section requires it's own home run to a power supply. They cannot be electrically connected together

Kilo Surface Corner Options

K-FC
Flat Corner

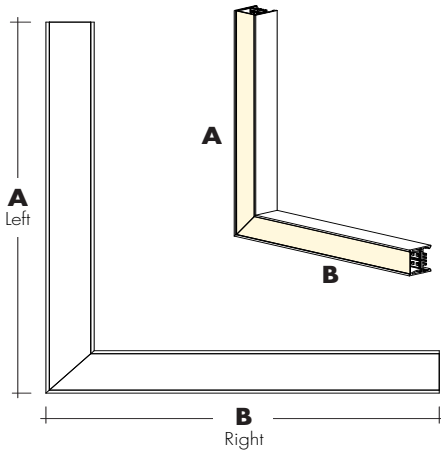

K-IC
Inner Corner

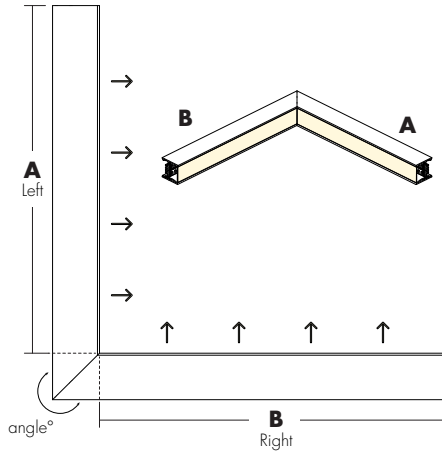

K-OC
Outside Corner

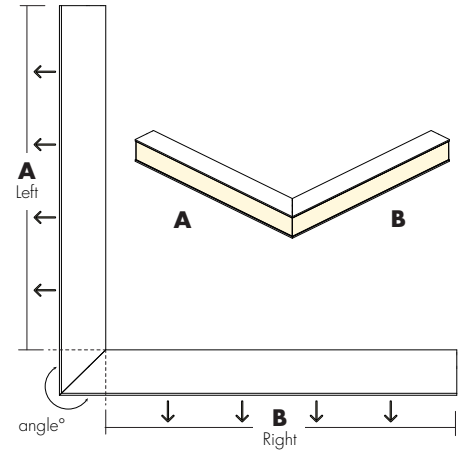

Tunable White	Actual Length		Total Wattage	
	A	B	TW68SO	TW68HO
Corner Type				
Flat (K-FC)	10 3/16	11 4/16	17.2	21.7
Outer (K-OC)	9 6/16	9 6/16	17.2	21.7
Inner (K-IC)	10 9/16	10 9/16	17.2	21.7

Warm Dimming	Actual Length		Total Wattage
	A	B	WD68SO
Corner Type			
Flat (KR-FC)	10 3/16	11 4/16	20.3
Outer (KR-OC)	9 6/16	9 6/16	20.3
Inner (KR-IC)	10 9/16	10 9/16	20.3

RGB/RGBW/PIXEL	Actual Length		Total Wattage				Actual Length		Total Wattage	
	A	B	RGBW36SO	RGBW36HO	RGB42SO	RGB42HO	A	B	RGBX18SO	RGBWX18SO
Corner Type										
Flat (K-FC)	12 3/16	13 3/16	13.8	26.3	16.0	29.9	12 3/16	13 3/16	18.3	14.6
Outer (K-OC)	11 5/16	11 5/16	13.8	26.3	16.0	29.9	11 5/16	11 5/16	18.3	14.6
Inner (K-IC)	12 9/16	12 9/16	13.8	26.3	16.0	29.9	12 9/16	12 9/16	18.3	14.6

Ordering Code

MODEL	CORNER	ANGLE ¹	OUTPUT ²	CCT	LENS ³	MOUNTING	FINISH ⁴	LEFT END CAP ⁵ (A)	RIGHT END CAP ⁵ (B)	POWER FEED LEFT END ⁷	POWER FEED RIGHT END ⁷
K - Kilo	IC - Inside Corner OC - Outside Corner FC - Flat Corner	90-90° C - Custom Angle Corner ¹	WD68SO - Standard	19K27K - 1900K-2700K	F - Frosted C - Clear N - None	CB - Concealed Bracket	BASE	LE - Endcap Left End	RE - Endcap Right End	LWE - End Wire Leads	RNPF - No Power Feed
							SA - Silver Anodized	RE - Endcap Right End	LN - No Endcap Left End	RN - No Endcap Right End	LFE - End Female Q/C
			RGBW36SO - Standard RGBW36HO - High RGB42SO - Standard RGB42HO - High	CLR - Color			POWDER COAT	LE - Endcap Left End	RE - Endcap Right End	LWB - Back Wire Leads	RNPF - No Power Feed
							BK - Black BZ - Bronze WH - White	LN - No Endcap Left End	RN - No Endcap Right End	LFB - Back Female Q/C	
			RGBWX18SO - Standard RGBX18SO - Standard	PXSPI - Smart Pixel Control		PREMIUM	LE - Endcap Left End	RE - Endcap Right End	LNPF - No Power Feed	RWE - End Wire Leads	
						MBK - Matte Black WN - Warm Nickel AB - Aged Brass PG - Polished Gold ⁸ CH - Chrome ⁸	LN - No Endcap Left End	RN - No Endcap Right End	RFE - End Female Q/C		
							LE - Endcap Left End	RE - Endcap Right End	LNPF - No Power Feed	RWB - Back Wire Leads	
							LN - No Endcap Left End	RN - No Endcap Right End	RFB - Back Female Q/C		

1 - Custom Angle Corners are available, please consult Inside Sales with specific request.
 2 - Warm Dim and Tunable White options can be used to comply with Title 24 JAB at max brightness depending on lens selection, see multiplier charts to calculate specific efficacy.
 3 - Continuous Lens may be ordered separately for multi-fixture runs to create an even, seamless appearance.

4 - Non Base finishes may have extended lead times. Custom RALs are available, please consult Inside Sales with specific request.
 5 - Polished Gold finishes and Chrome finishes have a maximum fixture length of 96".
 6 - End caps will have a hole for the wire feed if End Wire Leads are chosen for Power Feed.
 7 - Wire leads are 72" long.
 8 - NOTE: Each Kilo Surface fixture/section requires it's own home run to a power supply. They cannot be electrically connected together

Powerfeed options for Continuous Run Straight Fixtures

START FIXTURE (LEFT ENDCAP)

Wire leads/Female Q/C on Left End of Fixture

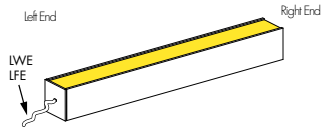

MIDDLE FIXTURE (NO ENDCAPS)

Wire leads/Female Q/C on Left or Right Back of Fixture

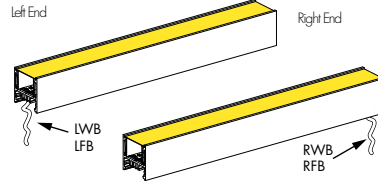

END FIXTURE (RIGHT ENDCAP)

Wire leads/Female Q/C on Right End of Fixture

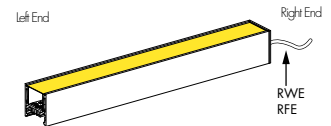

START FIXTURE (LEFT ENDCAP)

Wire leads/Female Q/C on Left or Right Back of Fixture

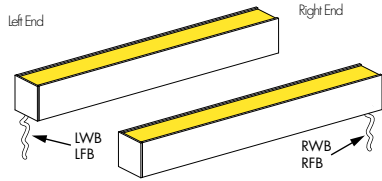

END FIXTURE (RIGHT ENDCAP)

Wire leads/Female Q/C on Left/Right Back of Fixture

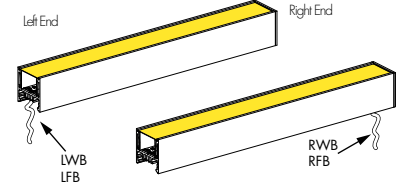

Powerfeed options for Single Straight Fixtures

SINGLE FIXTURE (TWO ENDCAPS)

Wire leads/Female Q/C on Left or Right End of Fixture

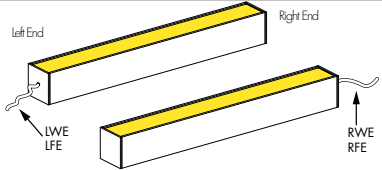

SINGLE FIXTURE (TWO ENDCAPS)

Wire leads/Female Q/C on Left or Right Back of Fixture

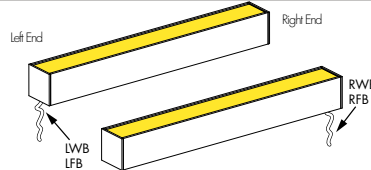

Powerfeed options for Corner Fixtures

KR-FC-90-XX-LNPF-RXX

Wire Leads or Female Quick Connect on Power Feed Right End/Back of Flat Corner

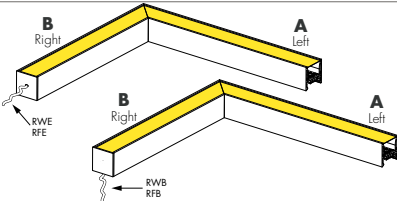

Note: Back Wire Feed also available on Power Feed Left End (A), but not shown

KR-FC-90-XX-LXX-RNPF

Wire Leads or Female Quick Connect on Power Feed Left End/Back of Flat Corner

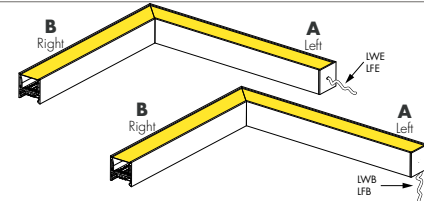

Note: Back Wire Feed also available on Power Feed Right End (B), but not shown

KR-IC-90-XX-LNPF-RXX

Wire Leads or Female Quick Connect on Power Feed Right End/Back of Inside Corner

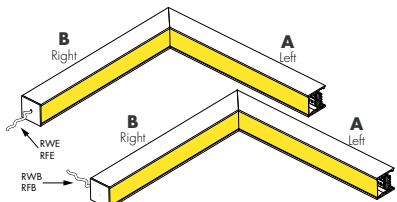

Note: Back Wire Feed also available on Power Feed Left End (A), but not shown

KR-IC-90-XX-LXX-RNPF

Wire Leads or Female Quick Connect on Power Feed Left End/Back of Inside Corner

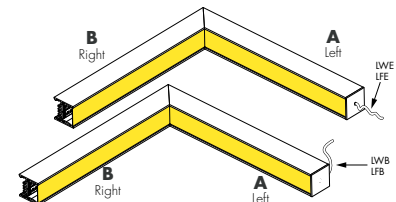

Note: Back Wire Feed also available on Power Feed Right End (B), but not shown

KR-OC-90-XX-LNPF-RXX

Wire Leads or Female Quick Connect on Power Feed Right End/Back of Outside Corner

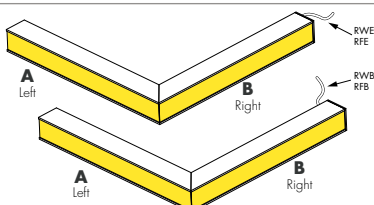

Note: Back Wire Feed also available on Power Feed Left End (A), but not shown

KR-OC-90-XX-LXX-RNPF

Wire Leads or Female Quick Connect on Power Feed Left End/Back of Outside Corner

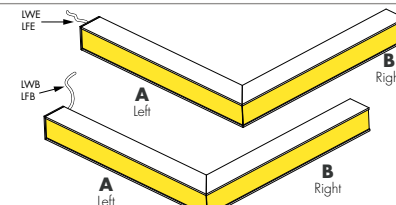

Note: Back Wire Feed also available on Power Feed Right End (B), but not shown

Product Dimensions

CB
Concealed Bracket

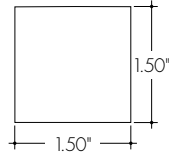
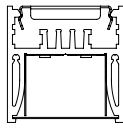

Left Side

Right Side

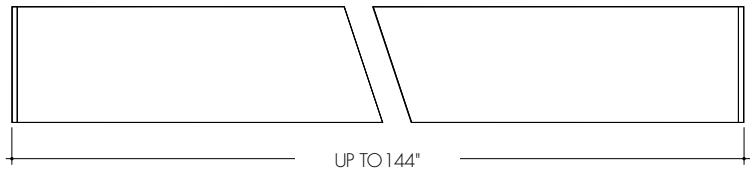

A
Adjustable Hinge
Mounting Bracket

Back cover plate on
adjustable hinge
mounting only

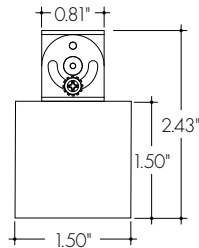
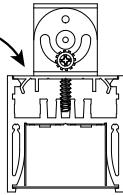

Left Side

Right Side

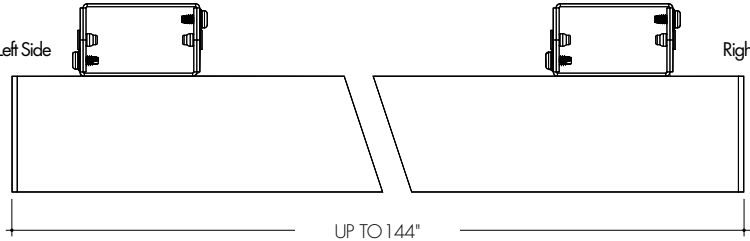

Adjustable Hinge Mounting Bracket is not available on system runs with corners

Finish Options

- Finish options are available in a wide variety, allowing for complete customization of style and aesthetic.
- Non Base finishes may have extended lead times and price adder.
- Polished Gold and Chrome finishes have a maximum fixture length of 96".
- Custom RALs are available, please consult Inside Sales with specific request.

**Silver Anodized
Base**

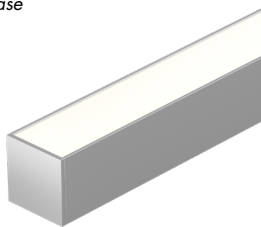

Silver Anodized is a soft silver with a clear finish.

**Black
Powder Coat**

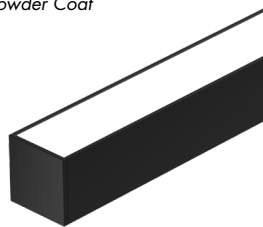

Black is a true deep black with a glossy finish.

**Bronze
Powder Coat**

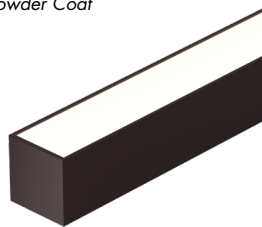

Bronze is a rich, dark brown with a satin finish.

**White
Powder Coat**

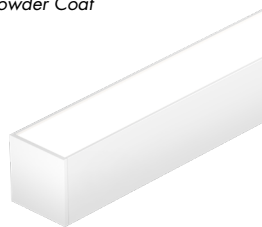

White is a polar bright white and field paintable.

**Matte Black
Premium**

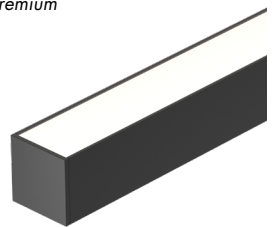

Matte Black is a dark, pitch-black with a soft flat finish.

**Warm Nickel
Premium**

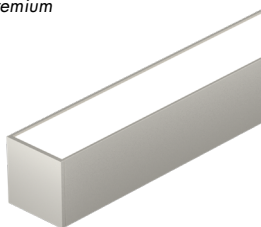

Warm Nickel is a soft, silvery smoke with warm tones and a satin finish.

**Aged Brass
Premium**

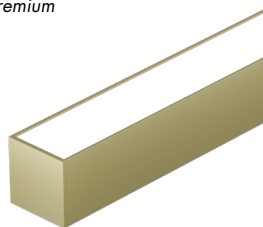

Aged Brass is a deep brown shade with slightly golden undertones.

**Polished Gold
Premium**

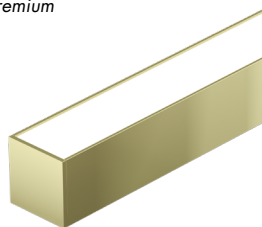

Polished Gold is bright and radiant for a brilliant finish.

**Chrome
Premium**

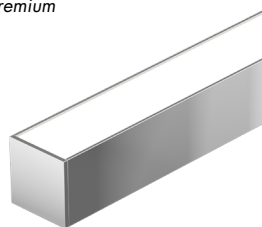

Chrome is a highly reflective silver polish.

Accessory Options

Continuous Lens (Field Cuttable)

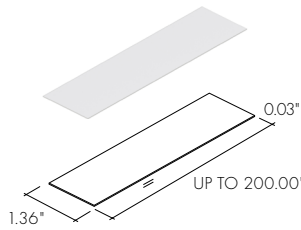

KILOCF-FF - Kilo Channel Continuous Frosted Lens
KILOCF-CC - Kilo Channel Continuous Clear Lens

XX - Order in 10' increments up to 200'

Note: Order the continuous (field cuttable) lens up to 200'. Recommended to avoid seams between multiple fixtures joining together.

LVSP-4T-BK

Low Voltage, 4 Terminal Splice Box, Black

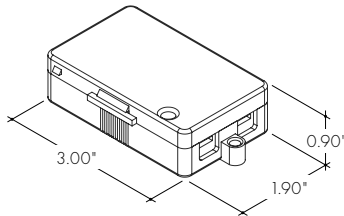

Powerfeeds and Connectors

Linking and Extension Cable Options

For use with Warm Dim (WD68):

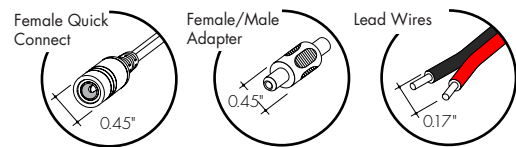

LMC-70
Male quick-connect long, 2 pin, 70"

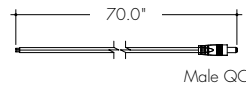

EC-48
Female/Female Extension Cable, 2 pin, 48"

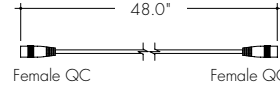

FMA
Female to male adapter

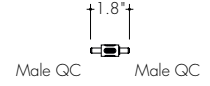

For use with Tunable White (TW68), RGB Pixel (RGBX18) and RGBW Pixel (RGBWX18):

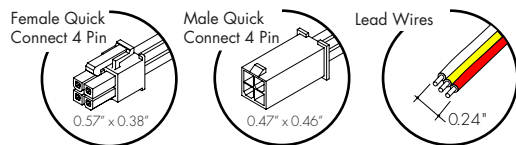

MOLEX-CON-LEAD-M-3-48
Molex Male Connector Cable, 3 pin, 48"

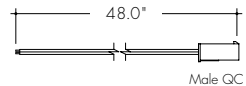

MOLEX-JC-F-M-3-48
Female/Male Jumper Cable, 3 pin, 48"

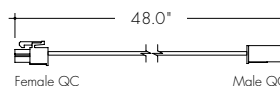

MOLEX-JC-M-M-3-4
Female to Male Adapter, 3 pin, 4"

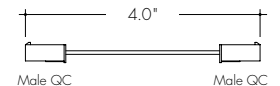

For use with RGB (RGB42):

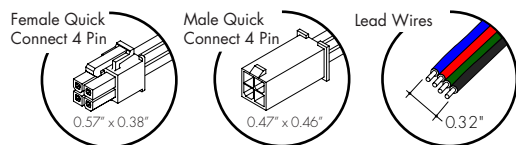

MOLEX-CON-LEAD-M-4-48
Molex Male Connector Cable, 4 pin, 48"

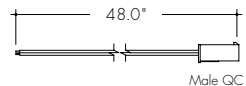

MOLEX-JC-F-M-4-48
Female/Male Jumper Cable, 4 pin, 48"

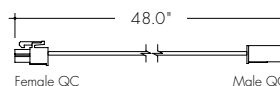

MOLEX-JC-M-M-4-4
Female to Male Adapter, 4 pin, 4"

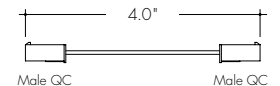

For use with RGBW (RGBW36):

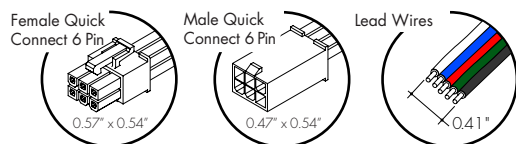

MOLEX-CON-LEAD-M-5-48
Molex Male Connector Cable, 5 pin, 48"

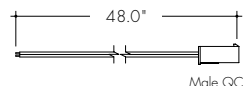

MOLEX-JC-F-M-5-48
Female/Male Jumper Cable, 5 pin, 48"

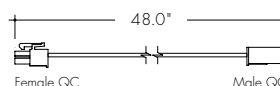

MOLEX-JC-M-M-5-4
Female to Male Adapter, 5 pin, 4"

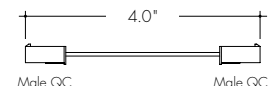

Sample Layout of Power Feed

K-XX-LE-RN-LWE-RNPF

End cap left end, no end cap right end of Fixture
Wire leads on the left end of Fixture

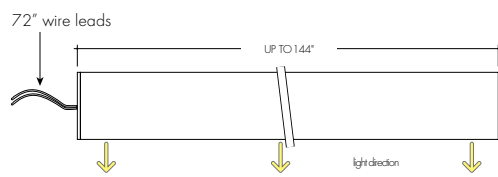

K-XX-LN-RN-LWB-RNPF

No end cap on left or right end of Fixture
Wire leads on the left backside of Fixture

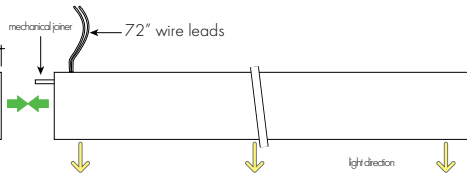

K-XX-LN-RE-LNPF-RFB

No end cap left end, end cap right end of Fixture
Female Q/C on the right backside of Fixture

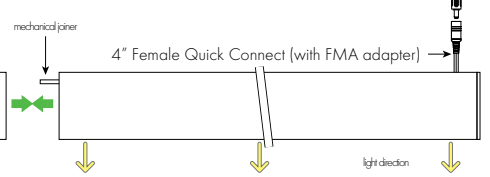

NOTE: Kilo Surface sections are not joined electrically. Each Kilo Surface section requires its own home run to the power supply. Mechanical joiners are included for every missing LEFT end cap (LN)

NOTE: When using Pixel output **RGBWX18SO** or **RGBX18SO**, powerfeed locations should follow the Pixel Path Direction

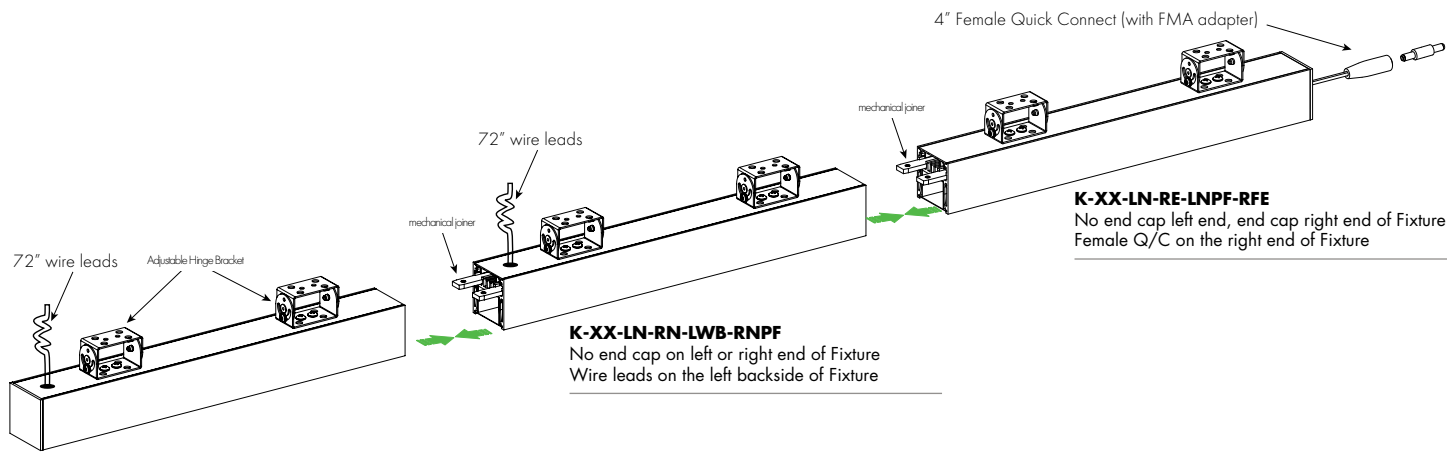
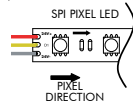

K-XX-LE-RN-LWB-RNPF

End cap left end, no end cap right end of Fixture
Wire leads on the left backside of Fixture

NOTE: Kilo Surface sections are not joined electrically. Each Kilo Surface section requires its own home run to the power supply. Adjustable hinge mounting brackets are not compatible with corners, or system runs that have corner sections in them.

Layout Example

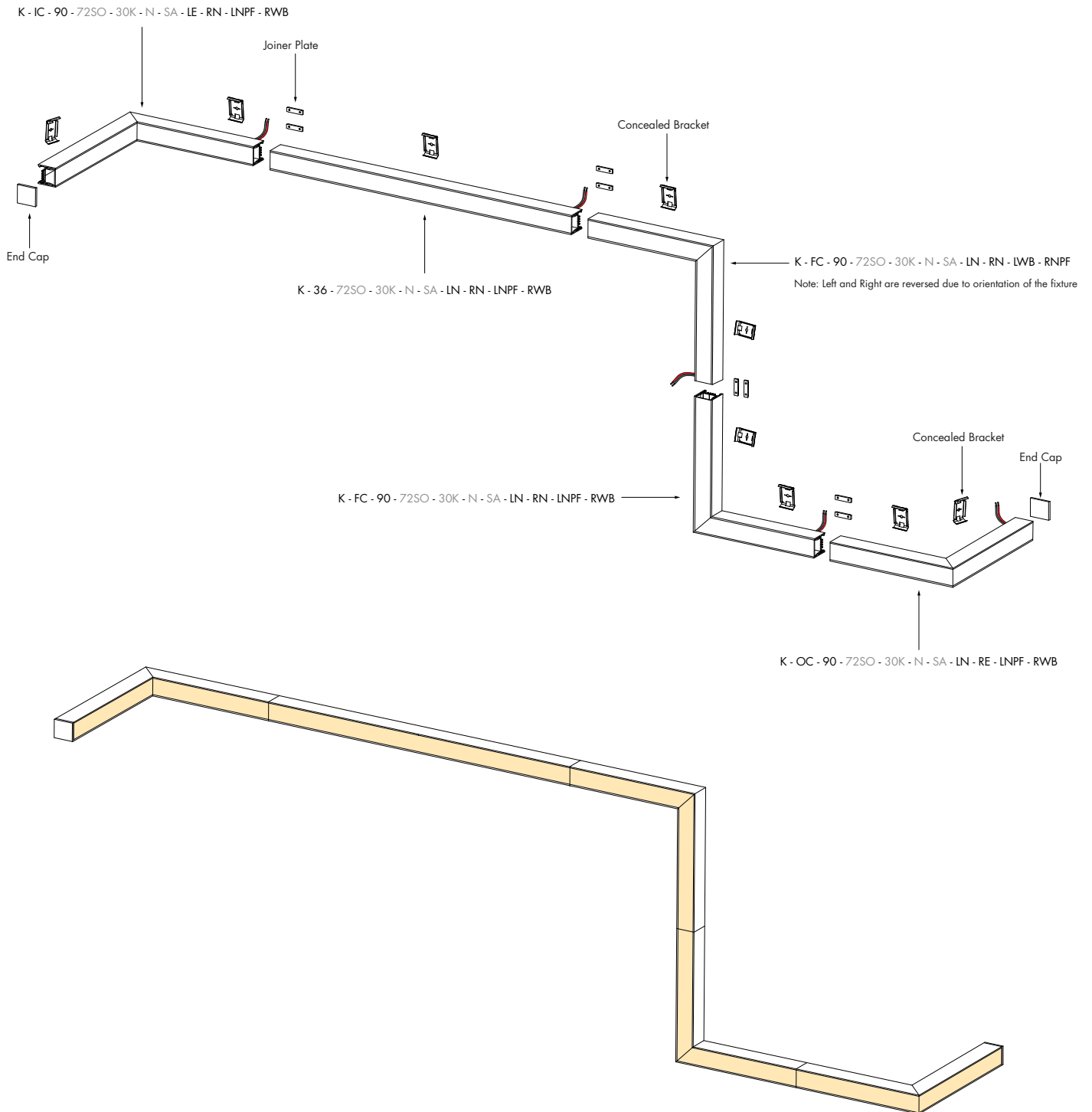

Light Transmission and Dotting

Output Options	Lens/Accessory							
	Clear Lens				Frosted Lens			
Dimming Level	100%	50%	10%	1%	100%	50%	10%	1%
WD68SO	CD	CD	CD	CD	ND	ND	ND	ND
TW68SO (All On)	CD	CD	CD	CD	ND	ND	ND	ND
TW68SO (1-Channel)	CD	CD	CD	CD	ND	ND	ND	ND
TW68HO (All On)	CD	CD	CD	CD	ND	ND	ND	ND
TW68HO (1-Channel)	CD	CD	CD	CD	ND	ND	ND	ND
RGBW36SO	CD	CD	CD	CD	ND	ND	ND	ND
RGBW36HO	CD	CD	CD	CD	ND	ND	ND	ND
RGB42SO	CD	CD	CD	CD	ND	ND	ND	ND
RGB42HO	CD	CD	CD	CD	ND	ND	ND	ND
RGBX18SO	CD	CD	CD	CD	ND	ND	ND	ND
RGBWX18SO	CD	CD	CD	CD	ND	ND	ND	ND
Transmission Percentage	114%				100%			

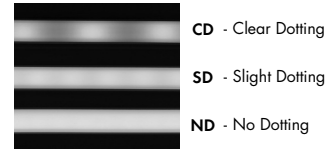

Power Consumption

Tested at Full Power with PS-UNI Series power supplies.

Standard Nominal Lengths offered provide minimal shadowing. For alternate lengths, please consult Inside Sales with specific request.

Warm Dim (2x WD68)

Nominal Length (in)	End Feed Actual Length*	Watts	Nominal Length (in)	End Feed Actual Length*	Watts	Nominal Length (in)	End Feed Actual Length*	Watts	Nominal Length (in)	End Feed Actual Length*	Watts
		SO			SO			SO			SO
12	10 4/16	9.2	47	--	--	82	81 10/16	69.5	117	116 1/16	95.0
13	12 11/16	11.6	48	47 3/16	42.1	83	--	--	118	--	--
14	--	--	49	--	--	84	--	--	119	118 8/16	--
15	--	--	50	49 10/16	44.0	85	84 1/16	71.4	120	--	--
16	15 3/16	13.8	51	--	--	86	--	--	121	121	--
17	--	--	52	--	--	87	86 9/16	73.4	122	--	--
18	17 10/16	16.0	53	52 1/16	45.9	88	--	--	123	--	--
19	--	--	54	--	--	89	89	75.3	124	123 7/16	--
20	--	--	55	54 9/16	48.1	90	--	--	125	--	--
21	20 2/16	18.2	56	--	--	91	--	--	126	125 14/16	--
22	--	--	57	--	--	92	91 7/16	77.2	127	--	--
23	22 9/16	20.3	58	57	50.3	93	--	--	128	--	--
24	--	--	59	--	--	94	93 15/16	79.1	129	128 6/16	--
25	--	--	60	59 7/16	52.2	95	--	--	130	--	--
26	25	22.5	61	--	--	96	--	--	131	130 13/16	--
27	--	--	62	61 15/16	54.1	97	96 6/16	81.0	132	--	--
28	27 8/16	24.7	63	--	--	98	--	--	133	--	--
29	--	--	64	--	--	99	98 13/16	82.7	134	133 5/16	--
30	29 15/16	26.9	65	64 6/16	56.1	100	--	--	135	--	--
31	--	--	66	--	--	101	--	--	136	135 12/16	--
32	--	--	67	66 14/16	58.0	102	101 5/16	84.4	137	--	--
33	32 6/16	29.0	68	--	--	103	--	--	138	--	--
34	--	--	69	--	--	104	103 12/16	86.1	139	138 3/16	--
35	34 14/16	31.2	70	69 5/16	59.9	105	--	--	140	--	--
36	--	--	71	--	--	106	--	--	141	140 11/16	--
37	--	--	72	71 12/16	61.8	107	106 3/16	87.8	142	--	--
38	37 5/16	33.4	73	--	--	108	--	--	143	--	--
39	--	--	74	--	--	109	108 11/16	89.7	144	143 2/16	--
40	39 12/16	35.6	75	74 4/16	64.0	110	--	--			
41	--	--	76	--	--	111	--	--			
42	--	--	77	76 11/16	66.1	112	111 2/16	91.6			
43	42 4/16	37.7	78	--	--	113	--	--			
44	--	--	79	--	--	114	113 10/16	93.3			
45	44 11/16	39.9	80	79 2/16	67.8	115	--	--			
46	--	--	81	--	--	116	--	--			

Power Consumption

Tested at Full Power with PS-UNI Series power supplies.

Standard Nominal Lengths offered provide minimal shadowing. For alternate lengths, please consult Inside Sales with specific request.

Tunable White (2x TW68)

Nominal Length (in)	Actual Length	Watts		Nominal Length (in)	Actual Length	Watts		Nominal Length (in)	Actual Length	Watts		Nominal Length (in)	Actual Length	Watts	
		SO	HO			SO	HO			SO	HO			SO	HO
12	10 4/16	7.9	9.8	47	–	–	–	82	81 10/16	53.5	62.9	117	116 1/16	68.0	73.9
13	12 11/16	9.8	12.3	48	47 3/16	34.9	43.3	83	–	–	–	118	–	–	–
14	–	–	–	49	–	–	–	84	–	–	–	119	118 8/16	68.8	74.3
15	–	–	–	50	49 10/16	36.4	44.8	85	84 1/16	55.4	64.0	120	–	–	–
16	15 3/16	11.8	14.8	51	–	–	–	86	–	–	–	121	121	69.6	74.7
17	–	–	–	52	–	–	–	87	86 9/16	57.0	65.4	122	–	–	–
18	17 10/16	13.4	16.8	53	52 1/16	38.0	46.3	88	–	–	–	123	–	–	–
19	–	–	–	54	–	–	–	89	89	58.5	66.9	124	123 7/16	70.4	75.1
20	–	–	–	55	54 9/16	39.7	47.8	90	–	–	–	125	–	–	–
21	20 2/16	15.3	19.3	56	–	–	–	91	–	–	–	126	125 14/16	71.2	75.5
22	–	–	–	57	–	–	–	92	91 7/16	59.8	68.3	127	–	–	–
23	22 9/16	17.2	21.7	58	57	40.8	49.7	93	–	–	–	128	–	–	–
24	–	–	–	59	–	–	–	94	93 15/16	60.6	69.3	129	128 6/16	71.7	75.9
25	–	–	–	60	59 7/16	41.9	51.5	95	–	–	–	130	–	–	–
26	25	19.0	24.0	61	–	–	–	96	–	–	–	131	130 13/16	72.2	76.3
27	–	–	–	62	61 15/16	43.3	53.0	97	96 6/16	61.4	70.4	132	–	–	–
28	27 8/16	20.7	26.3	63	–	–	–	98	–	–	–	133	–	–	–
29	–	–	–	64	–	–	–	99	98 13/16	62.3	71.3	134	133 5/16	72.7	76.7
30	29 15/16	22.5	28.6	65	64 6/16	45.0	54.3	100	–	–	–	135	–	–	–
31	–	–	–	66	–	–	–	101	–	–	–	136	135 12/16	73.2	77.1
32	–	–	–	67	66 14/16	46.5	55.7	102	101 5/16	63.1	72.2	137	–	–	–
33	32 6/16	24.6	30.6	68	–	–	–	103	–	–	–	138	–	–	–
34	–	–	–	69	–	–	–	104	103 12/16	64.0	72.8	139	138 3/16	73.7	77.5
35	34 14/16	26.7	32.4	70	69 5/16	47.3	57.4	105	–	–	–	140	–	–	–
36	–	–	–	71	–	–	–	106	–	–	–	141	140 11/16	74.1	77.9
37	–	–	–	72	71 12/16	48.1	59.1	107	106 3/16	64.8	73.2	142	–	–	–
38	37 5/16	28.4	34.3	73	–	–	–	108	–	–	–	143	–	–	–
39	–	–	–	74	–	–	–	109	108 11/16	65.6	73.5	144	143 2/16	74.5	78.3
40	39 12/16	29.5	36.4	75	74 4/16	49.3	60.1	110	–	–	–				
41	–	–	–	76	–	–	–	111	–	–	–				
42	–	–	–	77	76 11/16	50.6	61.0	112	111 2/16	66.3	73.5				
43	42 4/16	30.5	38.5	78	–	–	–	113	–	–	–				
44	–	–	–	79	–	–	–	114	113 10/16	67.1	73.6				
45	44 11/16	32.7	40.9	80	79 2/16	51.7	61.7	115	–	–	–				
46	–	–	–	81	–	–	–	116	–	–	–				

Power Consumption

Tested at Full Power with PS-UNI Series power supplies.

Standard Nominal Lengths offered provide minimal shadowing. For alternate lengths, please consult Inside Sales with specific request.

RGB/RGBW (2x RGB42 & 2x RGB36)

Nominal Length (in)	Actual Length	Watts				Nominal Length (in)	Actual Length	Watts				Nominal Length (in)	Actual Length	Watts				Nominal Length (in)	Actual Length	Watts			
		RGBW36		RGB42				RGBW36		RGB42				RGBW36		RGB42							
		SO	HO	SO	HO			SO	HO	SO	HO			SO	HO	SO	HO			SO	HO	SO	HO
12	10 4/16	6.2	12.1	7.4	13.9	47	-	-	-	-	82	81 2/16	50.1	84.3	55.0	85.4	117	116 9/16	66.5	-	72.1	-	
13	12 4/16	7.3	14.5	8.9	16.6	48	47 10/16	30.2	56.3	34.0	61.1	83	-	-	-	-	118	-	-	-	-	-	
14	-	-	-	-	-	49	-	-	-	-	84	83 1/16	51.2	85.4	56.1	86.4	119	118 8/16	67.4	-	72.9	-	
15	14 3/16	8.6	17.0	10.4	19.4	50	49 10/16	31.3	57.9	35.4	63.4	85	-	-	-	-	120	-	-	-	-	-	
16	-	-	-	-	-	51	-	-	-	-	86	85 1/16	52.3	-	57.1	-	121	120 8/16	68.2	-	73.6	-	
17	16 3/16	9.7	18.8	11.5	21.4	52	51 9/16	32.4	59.3	36.7	65.9	87	-	-	-	-	122	-	-	-	-	-	
18	-	-	-	-	-	53	-	-	-	-	88	87	53.2	-	58.2	-	123	122 7/16	69.3	-	73.6	-	
19	18 2/16	11.0	21.3	13.0	24.2	54	53 9/16	33.5	60.7	38.0	68.4	89	89	54.1	-	59.2	-	124	-	-	-	-	-
20	-	-	-	-	-	55	-	-	-	-	90	-	-	-	-	-	125	124 7/16	70.3	-	73.6	-	
21	20 2/16	12.4	23.8	14.5	27.0	56	55 8/16	34.8	62.6	39.3	70.5	91	90 15/16	55.1	-	60.2	-	126	-	-	-	-	-
22	-	-	-	-	-	57	-	-	-	-	92	-	-	-	-	-	127	126 6/16	71.4	-	73.5	-	
23	22 1/16	13.8	26.3	16.0	29.9	58	57 8/16	36.3	65.0	40.6	72.3	93	92 15/16	56.1	-	61.4	-	128	-	-	-	-	-
24	-	-	-	-	-	59	-	-	-	-	94	-	-	-	-	-	129	128 6/16	71.9	-	74.3	-	
25	24 1/16	15.1	28.8	17.5	32.7	60	59 7/16	37.8	67.5	41.9	74.0	95	94 14/16	57.2	-	62.5	-	130	-	-	-	-	-
26	-	-	-	-	-	61	-	-	-	-	96	-	-	-	-	-	131	130 5/16	72.5	-	75.1	-	
27	26	16.4	31.2	18.9	35.1	62	61 7/16	39.2	69.7	43.2	75.3	97	96 14/16	58.1	-	63.6	-	132	-	-	-	-	-
28	28	17.6	33.5	20.3	37.5	63	-	-	-	-	98	-	-	-	-	-	133	132 5/16	73.1	-	75.9	-	
29	-	-	-	-	-	64	63 6/16	40.3	71.7	44.4	76.1	99	98 13/16	58.8	-	64.7	-	134	-	-	-	-	-
30	29 15/16	18.9	35.9	21.7	39.8	65	-	-	-	-	100	-	-	-	-	-	135	134 4/16	73.4	-	76.2	-	
31	-	-	-	-	-	66	65 6/16	41.4	73.8	45.6	77.0	101	100 13/16	59.5	-	65.9	-	136	-	-	-	-	-
32	31 14/16	20.2	38.4	23.2	42.4	67	-	-	-	-	102	-	-	-	-	-	137	136 4/16	73.6	-	76.5	-	
33	-	-	-	-	-	68	67 5/16	42.5	75.5	46.8	78.1	103	102 12/16	60.3	-	66.9	-	138	-	-	-	-	-
34	33 14/16	21.5	41.0	24.7	45.1	69	-	-	-	-	104	-	-	-	-	-	139	138 3/16	73.9	-	76.8	-	
35	-	-	-	-	-	70	69 5/16	43.7	77.0	47.8	79.6	105	104 12/16	61.4	-	67.8	-	140	-	-	-	-	-
36	35 13/16	22.8	43.5	26.3	47.8	71	-	-	-	-	106	-	-	-	-	-	141	140 3/16	74.4	-	77.2	-	
37	-	-	-	-	-	72	71 4/16	44.9	78.5	48.8	81.0	107	106 11/16	62.5	-	68.6	-	142	-	-	-	-	-
38	37 13/16	24.1	46.0	27.6	50.2	73	-	-	-	-	108	-	-	-	-	-	143	142 2/16	74.7	-	77.5	-	
39	-	-	-	-	-	74	73 4/16	46.1	79.8	50.0	82.1	109	108 11/16	63.6	-	69.5	-	144	-	-	-	-	-
40	39 12/16	25.4	48.4	28.8	52.6	75	-	-	-	-	110	-	-	-	-	-	-	-	-	-	-	-	-
41	-	-	-	-	-	76	75 3/16	47.1	81.1	51.5	83.0	111	110 10/16	64.1	-	70.0	-	-	-	-	-	-	-
42	41 12/16	26.8	50.8	30.0	55.0	77	-	-	-	-	112	-	-	-	-	-	-	-	-	-	-	-	-
43	-	-	-	-	-	78	77 3/16	48.1	82.4	52.9	83.8	113	112 10/16	64.9	-	70.7	-	-	-	-	-	-	-
44	43 11/16	28.0	52.9	31.4	57.3	79	-	-	-	-	114	-	-	-	-	-	-	-	-	-	-	-	-
45	-	-	-	-	-	80	79 2/16	48.9	83.3	53.9	84.5	115	114 9/16	65.7	-	71.4	-	-	-	-	-	-	-
46	45 11/16	29.2	54.8	32.9	59.5	81	-	-	-	-	116	-	-	-	-	-	-	-	-	-	-	-	-

Power Consumption

Tested at Full Power with PS-UNI Series power supplies.

Standard Nominal Lengths offered provide minimal shadowing. For alternate lengths, please consult Inside Sales with specific request.

PIXEL (2x RGBX18 & 2x RGBWX18)

Nominal Length (in)	Actual Length	Watts		Nominal Length (in)	Actual Length	Watts		Nominal Length (in)	Actual Length	Watts		Nominal Length (in)	Actual Length	Watts	
		RGBX18	RGBWX18			RGBX18	RGBWX18			RGBX18	RGBWX18			RGBX18	RGBWX18
		SO	SO			SO	SO			SO	SO			SO	SO
12	8 5/16	9.2	11.3	47	-	-	-	82	-	-	-	117	-	-	-
13	12 4/16	9.2	11.3	48	47 10/16	34.9	43.9	83	-	-	-	118	-	-	-
14	-	-	-	49	-	-	-	84	83 1/16	59.5	74.1	119	118 8/16	81.8	-
15	-	-	-	50	-	-	-	85	-	-	-	120	-	-	-
16	-	-	-	51	-	-	-	86	-	-	-	121	-	-	-
17	16 3/16	12.2	15.1	52	51 9/16	37.7	47.4	87	-	-	-	122	-	-	-
18	-	-	-	53	-	-	-	88	87	62.2	77.4	123	122 7/16	84.2	-
19	-	-	-	54	-	-	-	89	-	-	-	124	-	-	-
20	-	-	-	55	-	-	-	90	-	-	-	125	-	-	-
21	20 2/16	15.2	18.8	56	55 8/16	40.5	50.8	91	90 15/16	64.8	80.7	126	-	-	-
22	-	-	-	57	-	-	-	92	-	-	-	127	126 6/16	86.6	-
23	-	-	-	58	-	-	-	93	-	-	-	128	-	-	-
24	-	-	-	59	-	-	-	94	-	-	-	129	-	-	-
25	24 1/16	18.2	22.6	60	59 7/16	43.3	54.2	95	94 14/16	66.7	83.2	130	-	-	-
26	-	-	-	61	-	-	-	96	-	-	-	131	130 5/16	89.0	-
27	-	-	-	62	-	-	-	97	-	-	-	132	-	-	-
28	28	21.1	26.4	63	-	-	-	98	-	-	-	133	-	-	-
29	-	-	-	64	63 6/16	46.1	57.6	99	98 13/16	69.3	86.4	134	-	-	-
30	-	-	-	65	-	-	-	100	-	-	-	135	134 4/16	91.4	-
31	-	-	-	66	-	-	-	101	-	-	-	136	-	-	-
32	31 14/16	23.3	29.2	67	-	-	-	102	-	-	-	137	-	-	-
33	-	-	-	68	67 5/16	48.8	61.1	103	102 12/16	71.8	89.7	138	-	-	-
34	-	-	-	69	-	-	-	104	-	-	-	139	138 3/16	93.7	-
35	-	-	-	70	-	-	-	105	-	-	-	140	-	-	-
36	35 13/16	26.3	33.0	71	-	-	-	106	-	-	-	141	-	-	-
37	-	-	-	72	71 4/16	51.5	64.5	107	106 11/16	74.3	92.9	142	-	-	-
38	-	-	-	73	-	-	-	108	-	-	-	143	142 2/16	-	-
39	-	-	-	74	-	-	-	109	-	-	-	144	-	-	-
40	39 12/16	29.2	36.6	75	-	-	-	110	-	-	-	-	-	-	-
41	-	-	-	76	75 3/16	54.2	67.8	111	110 10/16	76.8	-	-	-	-	-
42	-	-	-	77	-	-	-	112	-	-	-	-	-	-	-
43	-	-	-	78	-	-	-	113	-	-	-	-	-	-	-
44	43 11/16	32.0	40.3	79	-	-	-	114	-	-	-	-	-	-	-
45	-	-	-	80	79 2/16	56.9	70.9	115	114 9/16	79.3	-	-	-	-	-
46	-	-	-	81	-	-	-	116	-	-	-	-	-	-	-

Voltage Drop Calculator

The below chart assumes nominal voltage of 24 Volts and a Voltage Drop Allowance of 3% through the wire

Wattage [W]	Wire Length From Power Supply to Start of Run [ft]						
	12 AWG	14 AWG	16 AWG	18 AWG	20 AWG	22 AWG	24 AWG
5	1088.2	684.4	430.3	270.6	170.2	107.1	67.3
10	544.1	342.2	215.1	135.3	85.1	53.5	33.7
15	362.7	228.1	143.4	90.2	56.7	35.7	22.4
20	272.0	171.1	107.6	67.7	42.6	26.8	16.8
25	217.6	136.9	86.1	54.1	34.0	21.4	13.5
30	181.4	114.1	71.7	45.1	28.4	17.8	11.2
35	155.5	97.8	61.5	38.7	24.3	15.3	9.6
40	136.0	85.5	53.8	33.8	21.3	13.4	8.4
45	120.9	76.0	47.8	30.1	18.9	11.9	7.5
50	108.8	68.4	43.0	27.1	17.0	10.7	6.7
55	98.9	62.2	39.1	24.6	15.5	9.7	6.1
60	90.7	57.0	35.9	22.6	14.2	8.9	5.6
65	83.7	52.6	33.1	20.8	13.1	8.2	5.2
70	77.7	48.9	30.7	19.3	12.2	7.6	4.8
75	72.5	45.6	28.7	18.0	11.3	7.1	4.5
80	68.0	42.8	26.9	16.9	10.6	6.7	4.2
85	64.0	40.3	25.3	15.9	10.0	6.3	4.0
90	60.5	38.0	23.9	15.0	9.5	5.9	3.7
96	56.7	35.6	22.4	14.1	8.9	5.6	3.5

Power Supplies

See fixture and power supply instructions & spec sheet for wiring information. Dimming possible in select models - view Luminii website for list of compatible dimmers.

For use with Warm Dim, WD68

Ordering Code Phase Dimming Power Supply 1% 120VAC - 277VAC

MODEL	INPUT CONTROL	ENVIRONMENT	WATTAGE	OUTPUT	OUTPUT CONTROL
PS - Power Supply, 120-277VAC	PH - Phase Dimming (Triac, ELV, MLV)	D - Dry	96 - 96 Watts	24 - 24 VDC	DC - Direct Current

MLV/ELV/TRIAC - 1% dimming, consult dimming compatibility chart [\(Link\)](#)

MODELS	96W
Length	8.25"
Width	4.10"
Depth	1.56"

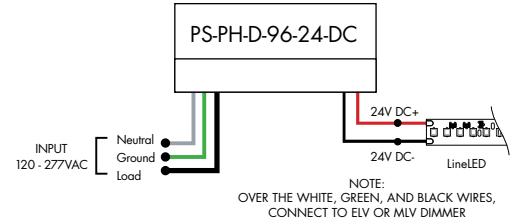

For use with Tunable White, TW68

Ordering Code DALI2 Dimming Power Supplies 0.1% 120VAC - 277VAC

MODEL	INPUT CONTROL	ENVIRONMENT	WATTAGE	OUTPUT	OUTPUT CONTROL
PS - Power Supply, 120-277VAC	DALI-DT8 - DALI DT8 Tunable White (0.1%)	D - Dry	96 - 96 Watts	24 - 24 VDC	PWM - Pulse Width Modulation

MODELS	96W
Length	14.40"
Width	5.20"
Depth	2.60"

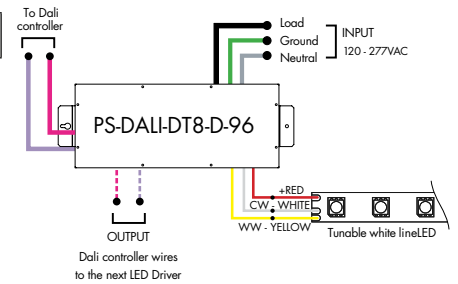

Athena DALI2-DT8 LED Driver

MODEL	INPUT CONTROL	ENVIRONMENT	WATTAGE	OUTPUT	FEATURE
PS - Power Supply, 120-277VAC	DALI-DT8 - DALI DT8 Tunable White	D - Dry	96 - 96 W	24 - 24 VDC	AWNDR - Athena

MODELS	96W
Length	14.40"
Width	5.20"
Depth	2.60"

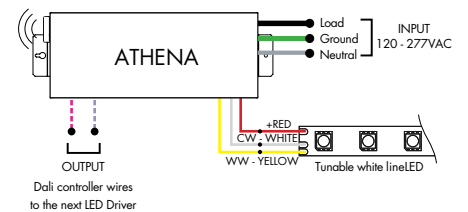

Power Supplies

See fixture and power supply instructions & spec sheet for wiring information. Dimming possible in select models - view Luminii website for list of compatible dimmers.

For use with Tunable White, TW68

Ordering Code VintageDim® 0 - 10V Dimming Power Supplies 120VAC - 277VAC

MODEL	INPUT CONTROL	ENVIRONMENT	WATTAGE	OUTPUT
PS - Power Supply, 120-277VAC	010V-WD - 0-10V Dimming, Standard Warm Dim Curve (with Tunable White LED) 010V-TW - 0-10V Dimming, Two Channel Control, Brightness and CCT1-CCT2 Ratio 010V-2CH - 0-10V Dimming, Two Channel Control, LED1 Brightness and LED2 Brightness 010V-WDX - 0-10V Dimming, Customizable Warm Dim Curve (with Tunable White LED) 010V-2CHX - 0-10V Dimming, Two Channel Control, Customizable Brightness and CCT1-CCT2 Ratio	D-Dry	96 - 96 Watts 3X96 - 3x96 Watts ¹	24 - 24 VDC

1 - 3x96 is only available with input control options 010V-WD and 010V-TW
 2 - Athena only available on 96 watts option

MODELS	96W	3X96
Length	14.40"	15.00"
Width	5.20"	6.62"
Depth	2.60"	4.56"

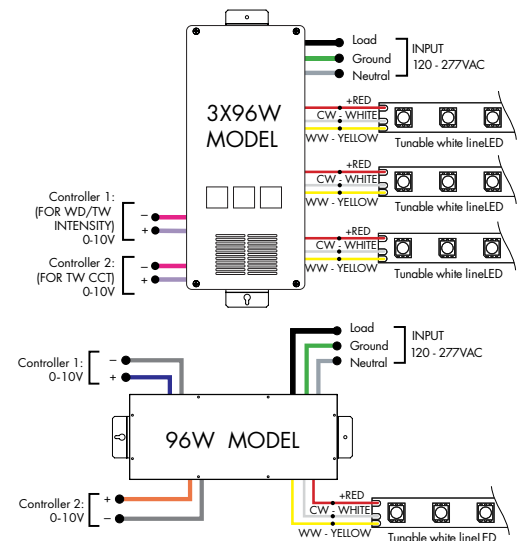

Athena 0-10V Warm Dim LED Driver

MODEL	INPUT CONTROL	ENVIRONMENT	WATTAGE	OUTPUT	FEATURE
PS - Power Supply, 120-277VAC	010V-WD - 0-10V Dimming, Standard Warm Dim Curve (with Dynamic White LED)	D-Dry	96-96 W	24-24 VDC	AWNDR-Athena

MODELS	96W
Length	14.40"
Width	5.20"
Depth	2.60"

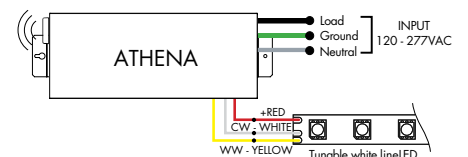

Athena 0-10V Two Channel LED Driver

MODEL	INPUT CONTROL	ENVIRONMENT	WATTAGE	OUTPUT	FEATURE
PS - Power Supply, 120-277VAC	010V-2CH - 0-10V Dimming Two Channel Control, LED1 Brightness and LED2 Brightness	D-Dry	96-96 W	24-24 VDC	AWNDR-Athena

MODELS	96W
Length	14.40"
Width	5.20"
Depth	2.60"

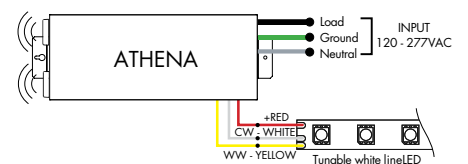

Power Supplies

See fixture and power supply instructions & spec sheet for wiring information. Dimming possible in select models - view Luminii website for list of compatible dimmers.

For use with RGB/RGBW, RGB42/RGBW36 or with Tunable White, TW68

Requires Controller

Ordering Code DMX Dimming Power Supplies 0.1% 120VAC - 277VAC

MODEL	INPUT CONTROL	ENVIRONMENT	WATTAGE	OUTPUT
PS-Power Supply, 120-277VAC	DMX-DMX (0.1%)	D-Dry	96-96 Watts 3X96-3X96 Watts	24-24 VDC

MODELS	96W	3X96
Length	14.40"	15.00"
Width	5.20"	6.62"
Depth	2.60"	4.56"

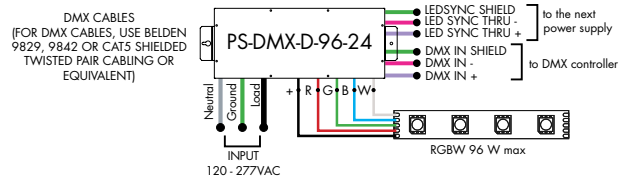
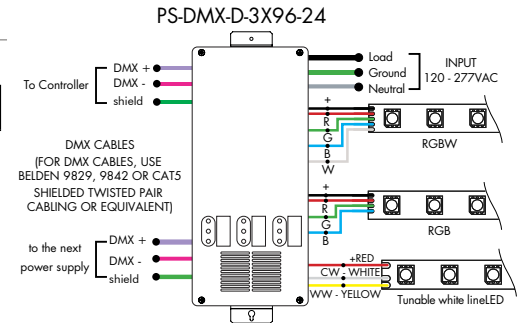

For use with RGB/RGBW/Pixel, RGB42/RGBW36/RGBX18/RGBWX18

Requires Controller and Decoder

Ordering Code Non-Dimming Power Supply 120VAC - 277VAC

MODEL	INPUT CONTROL	ENVIRONMENT	WATTAGE	OUTPUT
PS-Power Supply, 120-277VAC	ND-Non Dimming	D-Dry	96-96 Watts	24-24 VDC

MODELS	96W
Length	14.40"
Width	5.20"
Depth	2.60"

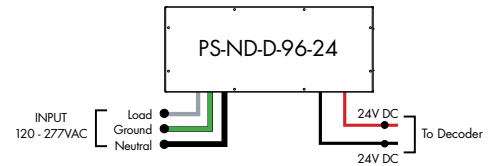

For use with RGB/RGBW/Pixel, RGB42/RGBW36/RGBX18/RGBWX18

Requires Controller and Decoder

Ordering Code Universal Dimming Power Supplies 1% 120VAC - 277VAC

MODEL	INPUT CONTROL	ENVIRONMENT	WATTAGE	OUTPUT
PS-Power Supply, 120-277VAC	UNI-0-10V Dimming, Phase Dimming	D-Dry W-Wet	30-30 Watts 60-60 Watts 96-96 Watts 3x96-3x96 Watts	24-24 VDC

Compatibility: View a complete list of compatible dimmers on product page [\(Link\)](#)

0-10V - 1% dimming
MLV/ELV/TRIAC - 1% dimming, consult dimming compatibility chart

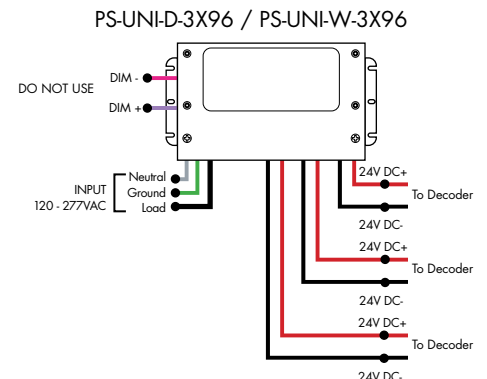
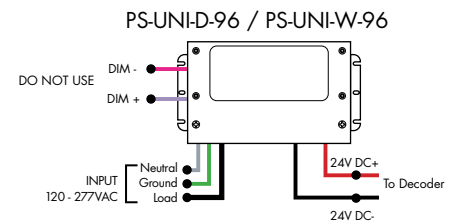

MODELS	PS-UNI-W-30W	PS-UNI-W-60W	PS-UNI-W-96W	PS-UNI-W-3X96W
Length	6.50"	7.40"	8.66"	11.85"
Width	3.73"	3.73"	3.73"	4.32"
Depth	1.61"	1.61"	1.61"	1.81"

MODELS	PS-UNI-D-30W	PS-UNI-D-60W	PS-UNI-D-96W	PS-UNI-D-3X96W
Length	8.77"	8.77"	8.11"	9.94"
Width	4.27"	4.27"	5.60"	7.61"
Depth	1.83"	1.83"	1.83"	2.02"

Controllers and Decoders

For use with Tunable White Power Supplies



MODEL

DTW-MC

DTW-MC - Tunable White controller

Tunable White wall-mount controller controls lighting fixtures, wireless control of TW lighting fixture. Fits in any standard US switch box. Includes all the outputs in the back of the controller.

Features

- Switch & dimming control function, control range > 20M.
- Smooth transition between light levels.
- Separately operate dimming and color temperature functions.
- Able to control 1 zone with endless receivers. Each receiver can maximally be controlled by 8 remotes.
- Power, temperature color and dimming functions operated by push button after receivers are connected.

Operating Voltage

3V DC battery

Color Parameters

- Brightness
- Saturation
- Fading



MODEL

TW-DMX

TW-DMX - DMX controller

Tunable White DMX wall-mount controller is a fully touch sensitive controller designed in accordance with standard protocol DMX512. Offers fast and accurate color temperature adjustment and brightness dimming of natural white, warm white and cold white. Designed with a touch color wheel, the DMX512 controller can adjust color temperature and brightness for all white LEDs smoothly and accurately. The DMX controller can control 1 zone with endless decoders.

Features

- 1 zone
- 6 color scenes
- DMX Control
- Touch Sensitive Glass Surface
- Dimming and Speed Control
- Memory Function
- Easily Fits Standard US Switch Boxes

Operating Voltage

12 - 24V DC

Color Parameters

- Brightness
- Saturation
- Primary colors
- Fading
- Color changing speed



MODEL

SLD-DIMTW

SLD-DIMTW - Tunable white LED dimming module

The SLD DimTW is a constant voltage warm dimming LED dimming module. The unique dimming module accepts 0-10V control and mimics a smooth, incandescent dimming curve.

Features

- Flicker free 0-100% dimming
- High efficiency up to 97%
- High precision dimming ratio:>1:1000
- Fully isolated plastic housing
- Comply with EN55015 and FCC part 15 without additional input filter and capacitors
- compact size, high reliability
- 3 years warranty

Operating Voltage

8-48 VDC

Controllers and Decoders

For use with Tunable White, RGB/RGBW Power Supplies



MODEL

RGBW-RC-R

RGBW-RC-R - RGBW receiver

The RGBW receiver is easily paired with controller by the click of a button. Receiver can be reset to factory settings at any time.

Each receiver can store one static RGB color, one color sequence, and one brightness setting for the white LED strip. Receivers assigned to the same scene within the same zone will have the same LED static color and color sequence.

Operating Voltage
12-36 VDC

Power Capacity
up to 96W at 24V

Operating Temperature Range
from -4°F to +122°F in case



MODEL

RGBW-SR

RGBW-SR - RGBW signal repeater

Extends identical signal when connected in series to an RGBW LED control system. The RGBW signal repeater works with Luminii RGB and RGBW controllers, receivers, and decoders.

RGBW signal can be extended indefinitely when adequate power supply (not included) is connected to the system.

Operating Voltage
12-36 VDC

Power Capacity
up to 96W at 24V

Operating Temperature Range
from -4°F to +122°F in case



MODEL

DDMX-RGBW

DDMX-RGBW - DMX decoder

Translates controller DMX512 programs for RGB and white LED strips.

Unique DMX address for the decoder can be set easily and displayed by the numeric display on the case. Changing and resetting the DMX address requires manual input.

Use power repeater to expand output.

Operating Voltage
12-36 VDC

Power Capacity
up to 96W at 24V

Operating Temperature Range
from -4°F to +122°F in case

Controllers and Decoders

For use with RGB/RGBW Power Supplies

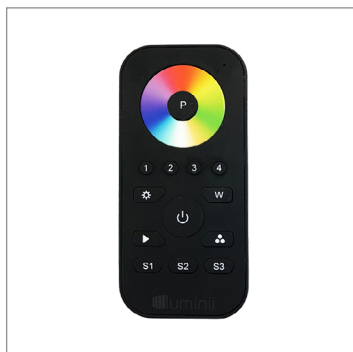

MODEL

RGBW-MC3

RGBW-MC3 - 4-zone RGBW controller

Easy to operate wireless interface suitable for static or color changing scenes. Control 4 different color zones separately or at the same time. RGBW receiver (RGBW-RC-R) required for operation. Assign multiple receivers per zone to cover a large area.

Color wheel enables highly stable and sensitive color control functionality. Create your own color changing sequences with ease and flexibility.

Power

qty 3 AAA batteries

Scenes

up to 4 unique zones

Signal

Wireless (RF)

Energy Saving

Deactivates after 10 seconds of inactivity

Color Parameters

- Brightness
- Saturation
- Primary colors
- Speed of color changing sequence
- Fading

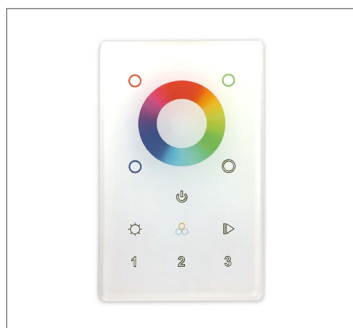

MODEL

ZONES

COLOR

DMX - DMX
Controller

3Z - Three Zone
1Z - One Zone

RGBW - Red,
Green,
Blue, &
White

DMX /Wireless RGB-W wall-mount controller controls DMX lighting fixtures, wireless control of RGB-W lighting fixture or use both simultaneously. Fits in any standard US switch box. Includes all the outputs in the back of the controller.

Control brightness levels with a single touch, personalize and memorize 3 different scenes, and even create 3 variations of white.

Features

- 2 in 1 in-Wall Controller: DMX Control or Wireless RGB-W
- 65,000 Color Options, Dimming and Speed Control
- Memory Function
- 50 Foot Wireless Range
- Easily Fits Standard US Switch Boxes
- Touch Sensitive Glass Surface
- Includes 10 Built in Programs, or Create and Play Your Own

Operating Voltage

12 - 24V DC

Color Parameters

- Brightness
- Saturation
- Primary colors
- Fading
- Color changing speed

For use with Tunable White, RGB/RGBW, Pixel Power Supplies

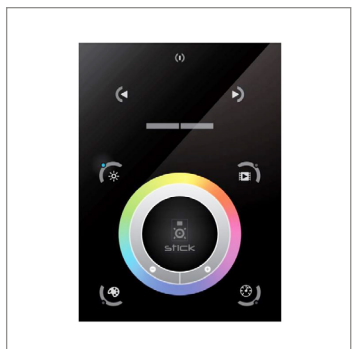

MODEL

TSDMX-E

TSDMX-E - Touchscreen DMX controller

Programmable advanced DMX512 lighting controller featuring a touch-screen interface. Operates as stand alone controller or integrated with most architectural lighting control systems. Can controller endless DMX512 enabled devices.

Mounts to standard single or dual gang wall box with the included power supply inside the junction box. Terminal block design for power and data connections.

Features

- Sleek glass design which sits 0.43" from the wall
- Graphical color display to show selected environment
- Color/dimmer/speed palette
- Color temperature mixing
- Touch sensitive buttons. No mechanical parts
- Touch sensitive wheel allows for accurate color selection
- Multi-zone microSD memory
- Multi-room control with 500 scenes, 10 zones
- 1024 DMX channels. Control 340 RGB fixtures
- USB & Ethernet connectivity for programming and control

Power Supply

7 VDC (included)

Programmability

PC, Mac, Tablet, Smartphone

Output Signal

DMX512 (1024 channels)

Color Parameters

- Brightness
- Saturation
- Speed of color changing sequence
- Fading / dimming / brightness

Controllers and Decoders

For use with Pixel Power Supplies



MODEL

SR-DMX-SPI

SR-DMX-SPI - Smart Pixel Decoder

The SR-DMX-SPI is a smart LED pixel decoder that controls RGB/RGBW pixel LED strips with SPI signal. Designed with an OLED backlit panel, the pixel controller allows for easy configuration of most settings. Four push buttons are available for control of the LED functions.
*For pixel only.

Features

- 2 in 1 in-Wall Controller: DMX Control or Wireless RGB-W
- SPI signal output for RGB/RGBW pixel light control
- DMX512 controllable and RF/WIFI remote controllable
- Capable of addressing up to 1020 RGB pixels & 765 RGBW pixels
- OLED panel allows for easy configuration

Operating Voltage

12 - 36V DC

Power capacity

up to 96W at 24V

Operating temperature range

from -4°F to +122°F in case

For use with Tunable White, RGB/RGBW Power Supplies



MODEL

DDMX-5CH-RDM-PRO

DDMX-5CH-RDM-PRO-DMX512 Decoder

DMX512 decoder with RDM functionality features 5 PWM output channels with common anode. High PWM output frequency range allows the product to be used in HD video conferencing spaces. All DMX products to be installed per DMX512 Standard.

Power

96 Watt

Inputs

RJ45, XLR-5Pin, Terminal Block

DMX Channels

1 to 5 settable

PWM Output Resolution Ratio

8 or 16 bit

PWM Output Frequency

500Hz - 30KHz

Output Dimming Curve Gamma Value

0.1 ~ 9.9



MODEL

RGBW-WI-R

RGBW-WI-R - WIFI generator

RGBW-WI-R creates a local network that enables any electronic device (phone, tablet, etc.) to control the RGB/W strip connected to a RGBW-RC-R receiver.

The control functions are achieved through a free application download for Android and iOS devices called REALCOLOR.

Operating Voltage

12-36 VDC

Power Supply

PI-130-24 (included)

Operating Temperature Range

from -4°F to +122°F in case