

Features

- 24VDC Class 2 fixtures made to order up to 144". Fixtures can be linked together to form one continuous run
- Suitable for installation in the storage area of a clothes closet on outputs 5.7W/ft or less, NEC compliant for the USA only.
- Dot free even illumination with frosted lens
- Class two listed for damp locations
- Proprietary strong bond solder method handles up to 50 lbs of pull force on wire leads and connectors
- Average Life (L70): 50,000hrs
- 7 year warranty
- Tunable White allows individual control of CCT and output, can be paired with Vintage Dim power supply for warm dim effect
- Warm Dim follows the incandescent dimming curve and is compatible with MLV, ELV, and Incandescent dimmers.
- RGB offers balanced output across the color gamut and a true white with RGBW
- Smart Pixel allows for infinite color combinations with cascading and chasing effects

Finish Options (see page 4 for additional information)

- Base Silver Anodized
-
- Powder Coat Black Bronze White
-
- Premium Matte Black Warm Nickel Aged Brass Polished Gold Chrome



Technical Information

TYPE	Warm Dim			Tunable White			RGB		RGBW		Pixel	
	2x WD51 (18K-30K)			2x TW51 (27K-65K)			2x RGB42		2x RGBW36		2x RGBX18	2x RGBWX18
OUTPUT OPTIONS	SO	HO	VHO	SO	HO	VHO	SO	HO	SO	HO	SO	SO
Lumens Output (All On w/ Frosted Lens)	282 lm/ft	593 lm/ft	844 lm/ft	627 lm/ft	778 lm/ft	1054 lm/ft	315 lm/ft	463 lm/ft	318 lm/ft	526 lm/ft	253 lm/ft	384 lm/ft
Average Power Consumption (for a 4" section)	4.6 W/ft	9.5 W/ft	13.8 W/ft	8.8 W/ft	10.9 W/ft	15.2 W/ft	9 W/ft	16.6 W/ft	8 W/ft	15.2 W/ft	9 W/ft	11.4 W/ft
Efficacy	61 lm/W	62 lm/W	61 lm/W	71 lm/W	71 lm/W	69 lm/W	35 lm/W	28 lm/W	40 lm/W	35 lm/W	28 lm/W	34 lm/W
Max Run Length (individual fixture)	12 ft	11 ft	7.5 ft	12 ft	11 ft	7.5 ft	12 ft	7ft	12 ft	6.5ft	12 ft	10ft
Ambient Operating Temperature Range*	-4°F - 122°F (-20°C - 50°C)		-4°F - 122°F (-20°C - 50°C)	-4°F - 122°F (-20°C - 50°C)		-4°F - 113°F (-20°C - 45°C)	-4°F - 122°F (-20°C - 50°C) -4°F - 95°F (-20°C - 35°C)		-4°F - 122°F (-20°C - 50°C) -4°F - 113°F (-20°C - 45°C)		-4°F - 122°F (-20°C - 50°C) -4°F - 122°F (-20°C - 50°C)	
Control/Dimming Protocol	0-10V, DALI, DALI2, MLV (Triac), ELV, Incandescent			0-10V, DMX, DALI-DT8			DMX, DALI-DT8		DMX, DALI-DT8		SPI Protocol UCS 2903 SPI Protocol UCS 2904	

* Ambient Operating Temperature Range to maintain L70 of 50k+ hours in normal mounting conditions for the fixture. Exceeding Ambient Operating Temperature Range may result in decreased life/output. Consult Technical Support for specific inquiries.

Warm Dim (WD51)

CCT	Multiplier (ref. - 18K30K)	TM-30			
		CRI	R _f	R _g	R ₉
18K24K	1800K	92	85	91	86
	2400K	96	95	104	97
18K27K	1800K	92	85	91	86
	2700K	96	95	104	96
18K30K	1800K	92	85	91	86
	3000K	95	95	104	90

Tunable White (TW51)

CCT	Multiplier (ref. - 27K65K)	TM-30			
		CRI	R _f	R _g	R ₉
18K30K	1800K	92	85	91	86
	2400K	95	93	106	98
	3000K	97	94	104	95
27K65K	2700K	97	95	103	93
	4200K	96	93	105	95
	6500K	91	90	101	63

RGBW (3000K)

Tape	TM-30			
	CRI	R _f	R _g	R ₉
RGBW36	95	93	106	84
RGBWX18	93	91	99	64

Dominant Wavelength

Color	RGB42/RGBW36	RGBX18/RGBWX18
Red	620nm	621nm
Green	525nm	519nm
Blue	467nm	465nm

Ordering Code

MODEL	LENGTH ¹	OUTPUT ²	CCT	LENS ³	MOUNTING	FINISH ⁴	LEFT END CAP ⁶	RIGHT END CAP ⁶	POWER FEED LEFT END ⁷	POWER FEED RIGHT END ⁷
K-Kilo	12"-144" 2" increments	WD51SO - Standard	18K24K - 1800K -2400K	F-Frosted C-Clear N-No Lens	CB-Concealed Bracket A-Adjustable Hinge Bracket, up to 90°	BASE SA-Silver Anodized	LE -Endcap Left End	RE -Endcap Right End	LWE -End Wire Leads	RNPF -No Power Feed
		WD51HO -High	18K27K - 1800K -2700K				RN -No Endcap Right End	LFE -End Female Q/C		
	12"-144" 2" increments	TW51SO - Standard	18K30K - 1800K -3000K			POWDER COAT BK-Black BZ-Bronze WH-White	LE -Endcap Left End	RE -Endcap Right End	LWB -Back Wire Leads	RNPF -No Power Feed
		TW51HO -High	27K65K - 2700K -6500K				LN -No Endcap Left End	RN -No Endcap Right End	LFB -Back Female Q/C	
12"-144" 2" increments	RGBW36SO - Standard		CLR -Color			PREMIUM MBK-Matte Black WN-Warm Nickel AB-Aged Brass PG-Polished Gold ⁵ CH-Chrome ⁵	LE -Endcap Left End	RE -Endcap Right End	LNPF -No Power Feed	RWE -End Wire Leads
	RGBW36HO -High						LN -No Endcap Left End		RFE -End Female Q/C	
12"-144" 4" increments	RGBWX18SO - Standard		PXSPI - Smart Pixel Control				LE -Endcap Left End	RE -Endcap Right End	LNPF -No Power Feed	RWB -Back Wire Leads
	RGBX18SO -Standard						LN -No Endcap Left End	RN -No Endcap Right End	RFB -Back Female Q/C	

1 - Custom lengths and increments are available, please consult Inside Sales with specific request.
 2 - Warm Dim and Tunable White options can be used to comply with Title 24 JAB at max brightness depending on lens selection, see multiplier charts to calculate specific efficacy.
 3 - Continuous Lens may be ordered separately for multi-fixture runs to create an even, seamless appearance.
 4 - Non Base finishes may have extended lead times. Custom RALs are available, please consult Inside Sales with specific request.
 5 - Polished Gold finishes and Chrome finishes have a maximum fixture length of 96".
 6 - End caps will have a hole for the wire feed if End Wire Leads are chosen for Power Feed.
 7 - Wire leads are 72" long.
 8 - NOTE: Each Kilo Surface fixture/section requires it's own home run to a power supply. They cannot be electrically connected together

Kilo Surface Corner Options

K-FC
Flat Corner

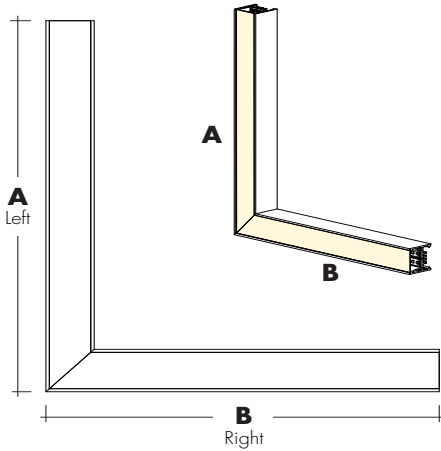

K-IC
Inner Corner

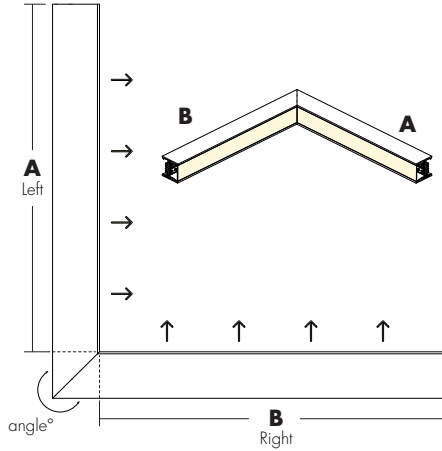

K-OC
Outside Corner

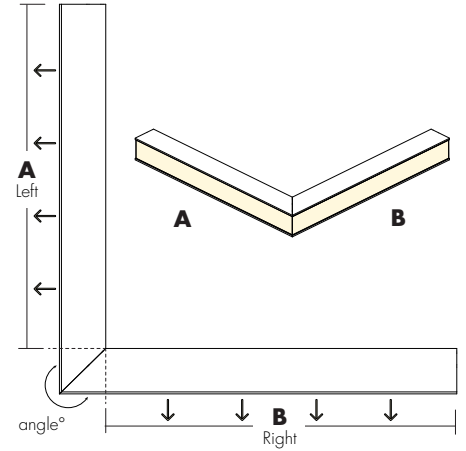

Corner Type	Actual Length		Total Wattage		
	A	B	2x WD51SO	2x WD51HO	2x WD51VHO
Flat (K-FC)	12"	13"	9.3	19.8	28.2
Inner (K-IC)	12 6/16"	12 6/16"	9.3	19.8	28.2
Outer (K-OC)	11 3/16"	11 3/16"	9.3	19.8	28.2

Corner Type	Actual Length		Total Wattage		
	A	B	2x TW51SO	2x TW51HO	2x TW51VHO
Flat (K-FC)	12"	13"	17.8	22.1	31.0
Inner (K-IC)	12 6/16"	12 6/16"	17.8	22.1	31.0
Outer (K-OC)	11 3/16"	11 3/16"	17.8	22.1	31.0

Corner Type	Actual Length		Total Wattage				Actual Length		Total Wattage	
	A	B	2x RGBW36SO	2x RGBW36HO	2x RGB42SO	2x RGB42HO	A	B	2x RGBX18SO	2x RGBWX18SO
Flat (K-FC)	12 5/16"	13 5/16"	19.9	37.4	16.9	31.8	12 5/16	13 5/16	18.7	23.9
Inner (K-IC)	12 12/16"	12 12/16"	19.9	37.4	16.9	31.8	12 12/16	12 12/16	18.7	23.9
Outer (K-OC)	11 8/16"	11 8/16"	19.9	37.4	16.9	31.8	11 8/16	11 8/16	18.7	23.9

Ordering Code

MODEL	CORNER	ANGLE ¹	OUTPUT ²		CCT	LENS ³	MOUNTING	FINISH ⁴	LEFT END CAP ⁶ (A)	RIGHT END CAP ⁶ (B)	POWER FEED LEFT END ⁷	POWER FEED RIGHT END ⁷
K - Kilo	IC - Inside Corner OC - Outside Corner FC - Flat Corner	90 - 90° C - Custom Angle Corner ¹	WD51SO - Standard	18K24K	1800K -2400K	F - Frosted C - Clear N - None	CB - Concealed Bracket	BASE SA - Silver Anodized	LE - Endcap Left End	RE - Endcap Right End RN - No Endcap Right End	LWE - End Wire Leads LFE - End Female Q/C	RNPF - No Power Feed
			WD51HO - High	18K27K	1800K -2700K							
			WD51VHO - Very High	18K30K	1800K -3000K							
			TW51SO - Standard	18K30K	1800K -3000K							
			TW51HO - High	27K65K	2700K -6500K			LE - Endcap Left End	RE - Endcap Right End	LWB - Back Wire Leads LFB - Back Female Q/C	RNPF - No Power Feed	
			TW51VHO - Very High					LN - No Endcap Left End	RN - No Endcap Right End			
			RGBW36SO - Standard		CLR - Color		PREMIUM MBK - Matte Black WN - Warm Nickel AB - Aged Brass PG - Polished Gold ⁵ CH - Chrome ⁵	LE - Endcap Left End	RE - Endcap Right End	LNPF - No Power Feed	RWE - End Wire Leads RFE - End Female Q/C	
		RGBW36HO - High		LN - No Endcap Left End		RN - No Endcap Right End						
		RGB42SO - Standard										
		RGB42HO - High										
			RGBWX18SO - Standard	PXSPI - Smart Pixel Control				LE - Endcap Left End	RE - Endcap Right End	LNPF - No Power Feed	RWB - Back Wire Leads RFB - Back Female Q/C	
			RGBX18SO - Standard					LN - No Endcap Left End	RN - No Endcap Right End			

1 - Custom Angle Corners are available, please consult Inside Sales with specific request.
 2 - Warm Dim and Tunable White options can be used to comply with Title 24 JAB at max brightness depending on lens selection, see multiplier charts to calculate specific efficacy.
 3 - Continuous lens may be ordered separately for multifixture runs to create an even, seamless appearance.
 4 - Non Base finishes may have extended lead times. Custom RALs are available, please consult Inside Sales with specific request.
 5 - Polished Gold finishes and Chrome finishes have a maximum fixture length of 96".
 6 - End caps will have a hole for the wire feed if End Wire Leads are chosen for Power Feed.
 7 - Wire leads are 72" long.
 8 - NOTE: Each Kilo Surface fixture/section requires it's own home run to a power supply. They cannot be electrically connected together.

Powerfeed options for Continuous Run Straight Fixtures

START FIXTURE (LEFT ENDCAP)

Wire leads/Female Q/C on Left End of Fixture

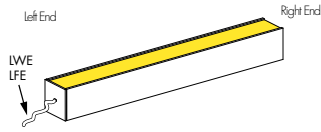

MIDDLE FIXTURE (NO ENDCAPS)

Wire leads/Female Q/C on Left or Right Back of Fixture

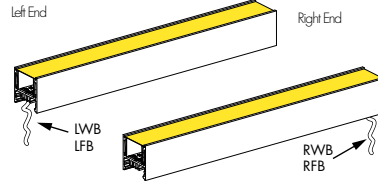

END FIXTURE (RIGHT ENDCAP)

Wire leads/Female Q/C on Right End of Fixture

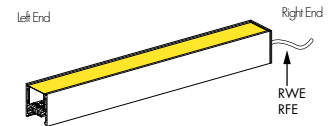

START FIXTURE (LEFT ENDCAP)

Wire leads/Female Q/C on Left or Right Back of Fixture

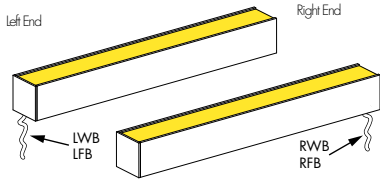

END FIXTURE (RIGHT ENDCAP)

Wire leads/Female Q/C on Left/Right Back of Fixture

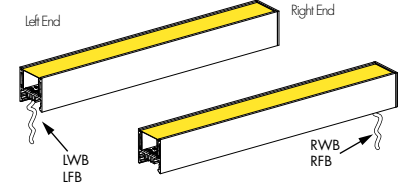

Powerfeed options for Single Straight Fixtures

SINGLE FIXTURE (TWO ENDCAPS)

Wire leads/Female Q/C on Left or Right End of Fixture

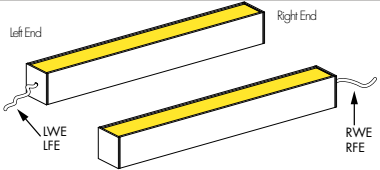

SINGLE FIXTURE (TWO ENDCAPS)

Wire leads/Female Q/C on Left or Right Back of Fixture

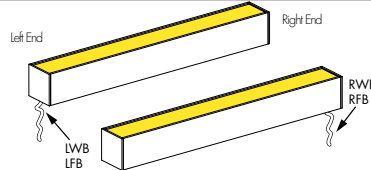

Powerfeed options for Corner Fixtures

KR-FC-90-XX-LNPF-RXX

Wire Leads or Female Quick Connect on Power Feed Right End/Back of Flat Corner

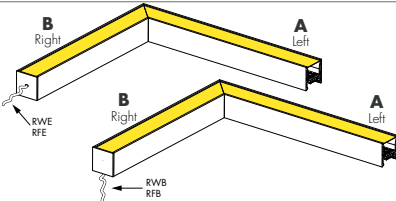

Note: Back Wire Feed also available on Power Feed Left End (A), but not shown

KR-FC-90-XX-LXX-RNPF

Wire Leads or Female Quick Connect on Power Feed Left End/Back of Flat Corner

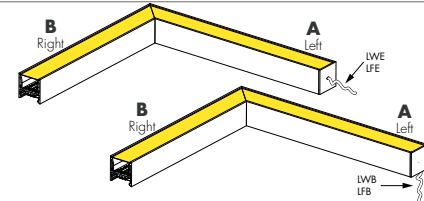

Note: Back Wire Feed also available on Power Feed Right End (B), but not shown

KR-IC-90-XX-LNPF-RXX

Wire Leads or Female Quick Connect on Power Feed Right End/Back of Inside Corner

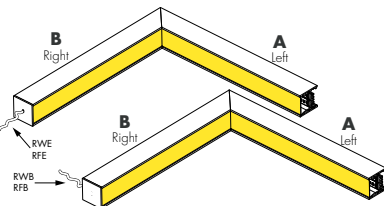

Note: Back Wire Feed also available on Power Feed Left End (A), but not shown

KR-IC-90-XX-LXX-RNPF

Wire Leads or Female Quick Connect on Power Feed Left End/Back of Inside Corner

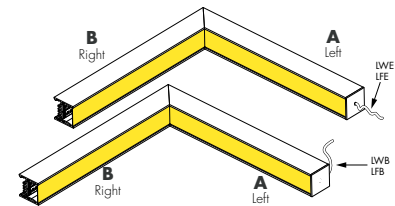

Note: Back Wire Feed also available on Power Feed Right End (B), but not shown

KR-OC-90-XX-LNPF-RXX

Wire Leads or Female Quick Connect on Power Feed Right End/Back of Outside Corner

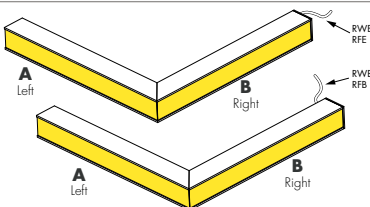

Note: Back Wire Feed also available on Power Feed Left End (A), but not shown

KR-OC-90-XX-LXX-RNPF

Wire Leads or Female Quick Connect on Power Feed Left End/Back of Outside Corner

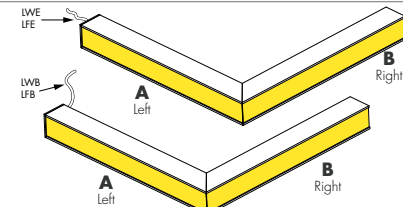

Note: Back Wire Feed also available on Power Feed Right End (B), but not shown

Product Dimensions

CB
Concealed Bracket

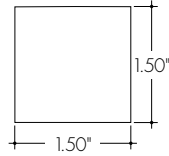
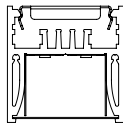

Left Side

Right Side

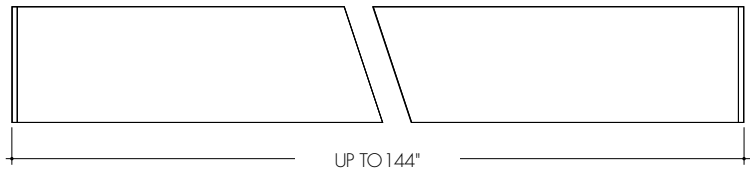

A
Adjustable Hinge
Mounting Bracket

Back cover plate on adjustable hinge mounting only

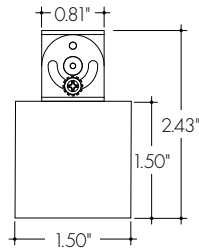
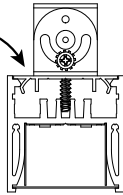

Left Side

Right Side

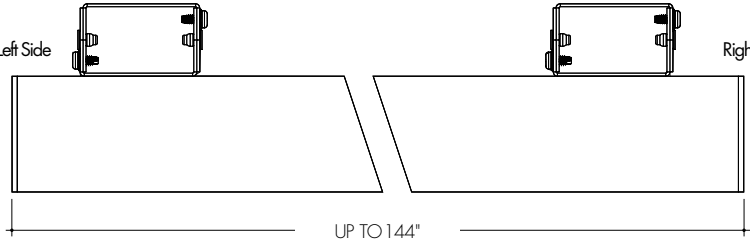

Adjustable Hinge Mounting Bracket is not available on system runs with corners

Finish Options

- Finish options are available in a wide variety, allowing for complete customization of style and aesthetic.
- Non Base finishes may have extended lead times and price adder.
- Polished Gold and Chrome finishes have a maximum fixture length of 96".
- Custom RALs are available, please consult Inside Sales with specific request.

Silver Anodized Base

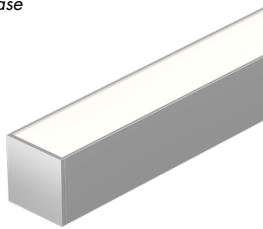

Silver Anodized is a soft silver with a clear finish.

Black Powder Coat

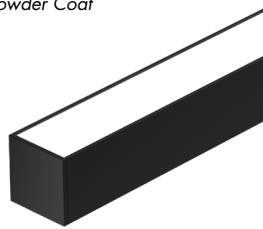

Black is a true deep black with a glossy finish.

Bronze Powder Coat

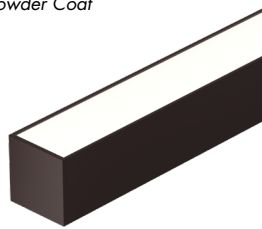

Bronze is a rich, dark brown with a satin finish.

White Powder Coat

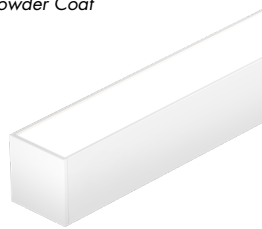

White is a polar bright white and field paintable.

Matte Black Premium

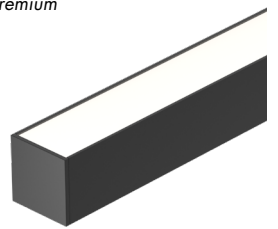

Matte Black is a dark, pitch-black with a soft flat finish.

Warm Nickel Premium

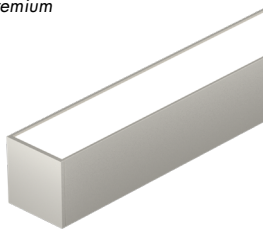

Warm Nickel is a soft, silvery smoke with warm tones and a satin finish.

Aged Brass Premium

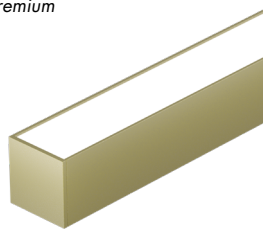

Aged Brass is a deep brown shade with slightly golden undertones.

Polished Gold Premium

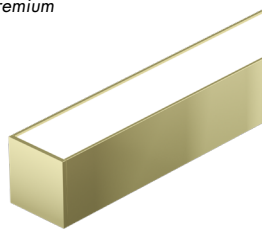

Polished Gold is bright and radiant for a brilliant finish.

Chrome Premium

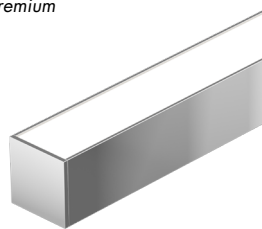

Chrome is a highly reflective silver polish.

Accessory Options

Continuous Lens (Field Cuttable)

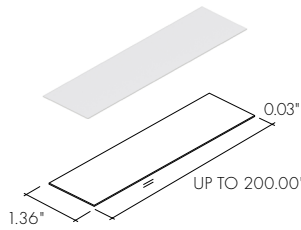

KILOCF-FF - Kilo Channel Continuous Frosted Lens
KILOCF-CC - Kilo Channel Continuous Clear Lens

XX - Order in 10' increments up to 200'

Note: Order the continuous (field cuttable) lens up to 200'. Recommended to avoid seams between multiple fixtures joining together.

LVSP-4T-BK

Low Voltage, 4 Terminal Splice Box, Black, IP20

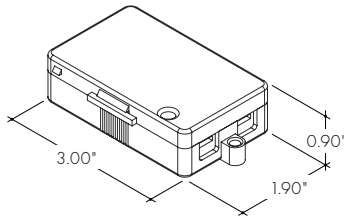

Powerfeeds and Connectors

Linking and Extension Cable Options

For use with Warm Dim (WD51):

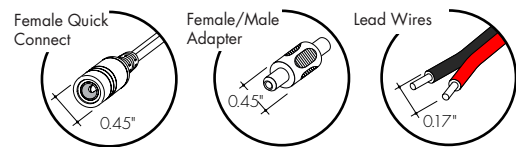

LMC-70
Male quick-connect long, 2 pin, 70"

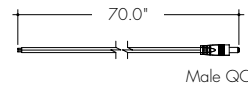

EC-48
Female/Female Extension Cable, 2 pin, 48"

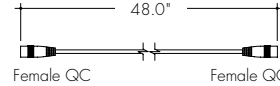

FMA
Female to male adapter

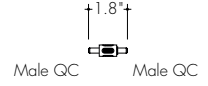

For use with Tunable White (TW51), RGB Pixel (RGBX18) and RGBW Pixel (RGBWX18):

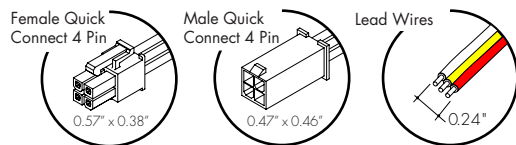

MOLEX-CON-LEAD-M-3-48
Molex Male Connector Cable, 3 pin, 48"

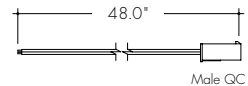

MOLEX-JC-F-M-3-48
Female/Male Jumper Cable, 3 pin, 48"

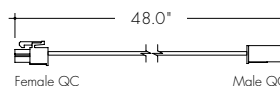

MOLEX-JC-M-M-3-4
Female to Male Adapter, 3 pin, 4"

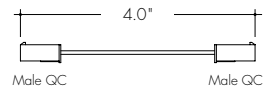

For use with RGB (RGB42):

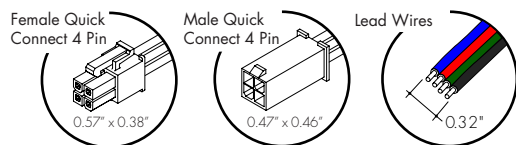

MOLEX-CON-LEAD-M-4-48
Molex Male Connector Cable, 4 pin, 48"

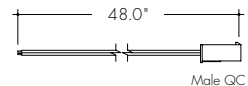

MOLEX-JC-F-M-4-48
Female/Male Jumper Cable, 4 pin, 48"

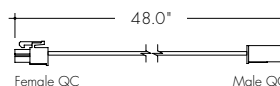

MOLEX-JC-M-M-4-4
Female to Male Adapter, 4 pin, 4"

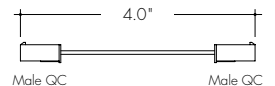

For use with RGBW (RGBW36):

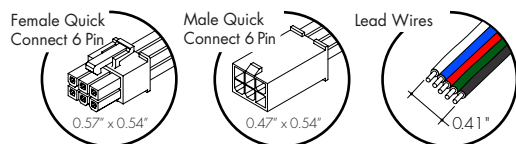

MOLEX-CON-LEAD-M-5-48
Molex Male Connector Cable, 5 pin, 48"

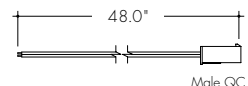

MOLEX-JC-F-M-5-48
Female/Male Jumper Cable, 5 pin, 48"

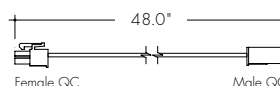

MOLEX-JC-M-M-5-4
Female to Male Adapter, 5 pin, 4"

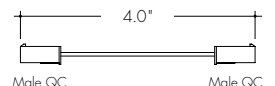

Sample Layout of Power Feed

K-XX-LE-RN-LWE-RNPF

End cap left end, no end cap right end of Fixture
Wire leads on the left end of Fixture

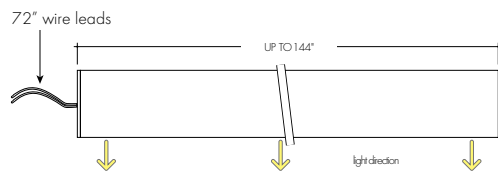

K-XX-LN-RN-LWB-RNPF

No end cap on left or right end of Fixture
Wire leads on the left backside of Fixture

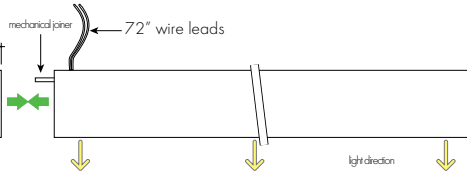

K-XX-LN-RE-LNPF-RFB

No end cap left end, end cap right end of Fixture
Female Q/C on the right backside of Fixture

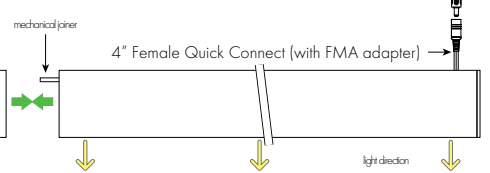

NOTE: Kilo Surface sections are not joined electrically. Each Kilo Surface section requires its own home run to the power supply. Mechanical joiners are included for every missing LEFT end cap (LN)

NOTE: When using Pixel output RGBWX18SO or RGBX18SO, powerfeed locations should follow the Pixel Path Direction

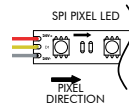

NOTE: When ordering continuous runs with RGBWX18SO or RGBX18SO pixel output option, power must come from one direction only.

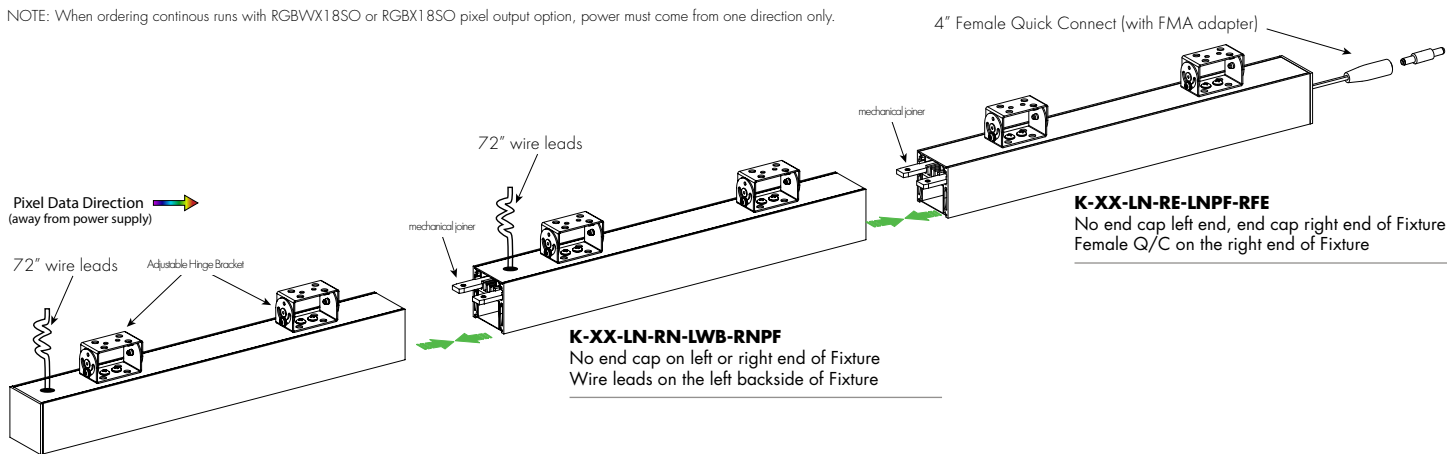

K-XX-LE-RN-LWB-RNPF

End cap left end, no end cap right end of Fixture
Wire leads on the left backside of Fixture

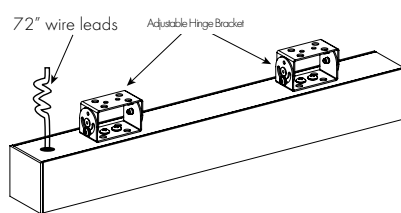

K-XX-LN-RN-LWB-RNPF

No end cap on left or right end of Fixture
Wire leads on the left backside of Fixture

K-XX-LN-RE-LNPF-RFE

No end cap left end, end cap right end of Fixture
Female Q/C on the right end of Fixture

NOTE: Kilo Surface sections are not joined electrically. Each Kilo Surface section requires its own home run to the power supply. Adjustable hinge mounting brackets are not compatible with corners, or system runs that have corner sections in them.

Layout Example

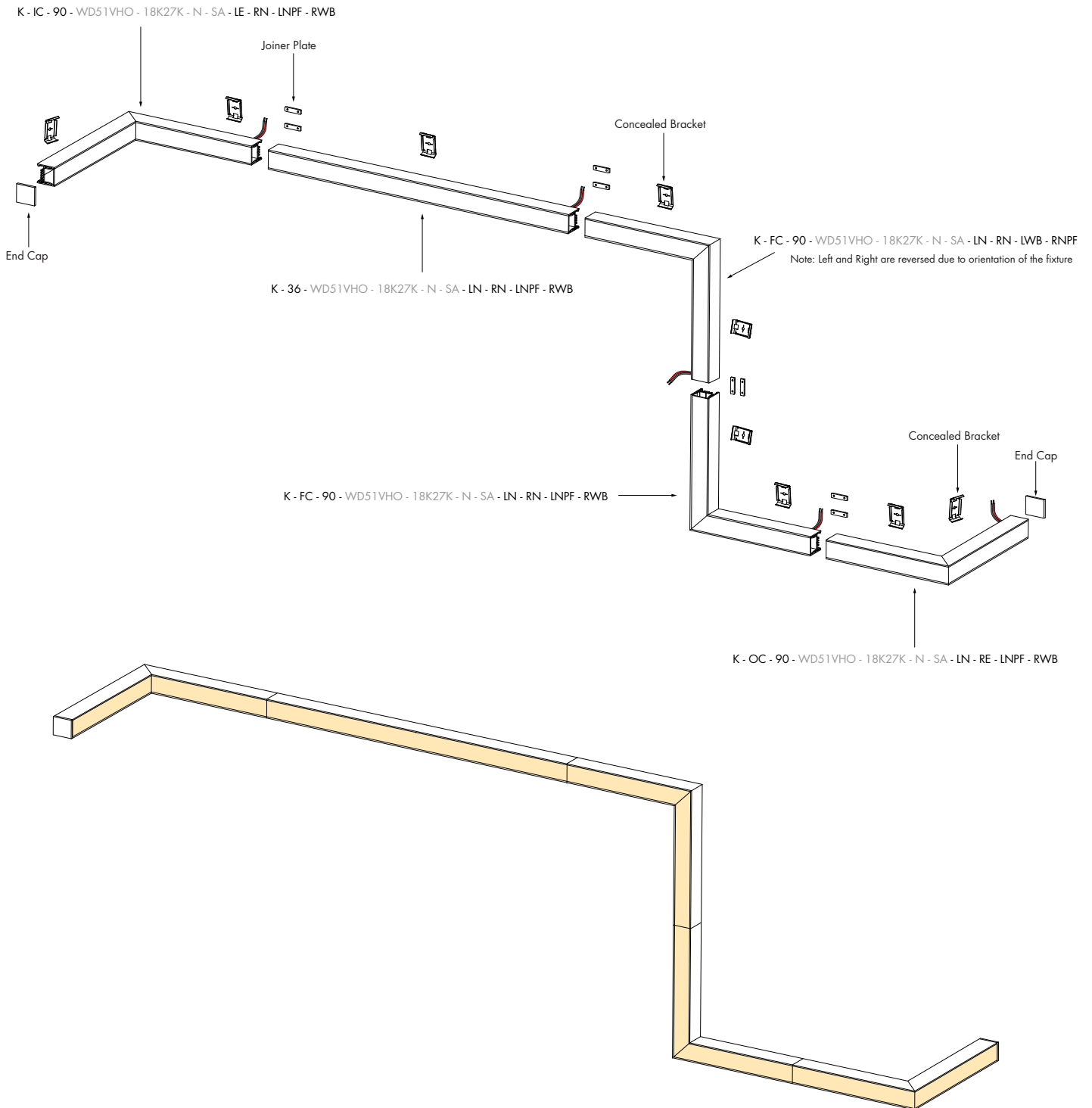

Light Transmission and Dotting

Output Options	Lens/Accessory							
	Clear Lens				Frosted Lens			
Dimming Level	100%	50%	10%	1%	100%	50%	10%	1%
WD51SO	CD	CD	CD	CD	ND	ND	ND	ND
WD51HO	CD	CD	CD	CD	ND	ND	ND	ND
WD51VHO	CD	CD	CD	CD	ND	ND	ND	ND
TW51SO (All On)	CD	CD	CD	CD	ND	ND	ND	ND
TW51HO (All On)	CD	CD	CD	CD	ND	ND	ND	ND
TW51VHO (All On)	CD	CD	CD	CD	ND	ND	ND	ND
TW51SO (1 CH)	CD	CD	CD	CD	ND	ND	ND	ND
TW51HO (1 CH)	CD	CD	CD	CD	ND	ND	ND	ND
TW51VHO (1 CH)	CD	CD	CD	CD	ND	ND	ND	ND
RGBW36SO	CD	CD	CD	CD	ND	ND	ND	ND
RGBW36HO	CD	CD	CD	CD	ND	ND	ND	ND
RGB42SO	CD	CD	CD	CD	ND	ND	ND	ND
RGB42HO	CD	CD	CD	CD	ND	ND	ND	ND
RGBWX18SO	CD	CD	CD	CD	ND	ND	ND	ND
RGBX18SO	CD	CD	CD	CD	ND	ND	ND	ND
Transmission Percentage	114%				100%			

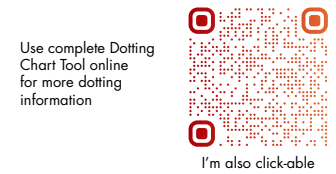
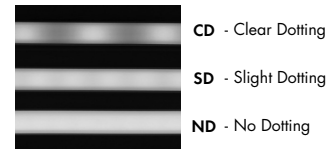

Power Consumption

Please visit the link/QR code below to access the Luminii Power Consumption Chart tool on our website.

There you will be able to select your fixture, output, and desired power feed to get a full power consumption table.



I'm also click-able

Desired Nominal Length: _____

Desired Output: _____

Desired CCT: _____

Voltage Drop Calculator

The below chart assumes nominal voltage of 24 Volts and a Voltage Drop Allowance of 3% through the wire

Wattage [W]	Wire Length From Power Supply to Start of Run [ft]						
	12 AWG	14 AWG	16 AWG	18 AWG	20 AWG	22 AWG	24 AWG
5	1088.2	684.4	430.3	270.6	170.2	107.1	67.3
10	544.1	342.2	215.1	135.3	85.1	53.5	33.7
15	362.7	228.1	143.4	90.2	56.7	35.7	22.4
20	272.0	171.1	107.6	67.7	42.6	26.8	16.8
25	217.6	136.9	86.1	54.1	34.0	21.4	13.5
30	181.4	114.1	71.7	45.1	28.4	17.8	11.2
35	155.5	97.8	61.5	38.7	24.3	15.3	9.6
40	136.0	85.5	53.8	33.8	21.3	13.4	8.4
45	120.9	76.0	47.8	30.1	18.9	11.9	7.5
50	108.8	68.4	43.0	27.1	17.0	10.7	6.7
55	98.9	62.2	39.1	24.6	15.5	9.7	6.1
60	90.7	57.0	35.9	22.6	14.2	8.9	5.6
65	83.7	52.6	33.1	20.8	13.1	8.2	5.2
70	77.7	48.9	30.7	19.3	12.2	7.6	4.8
75	72.5	45.6	28.7	18.0	11.3	7.1	4.5
80	68.0	42.8	26.9	16.9	10.6	6.7	4.2
85	64.0	40.3	25.3	15.9	10.0	6.3	4.0
90	60.5	38.0	23.9	15.0	9.5	5.9	3.7
96	56.7	35.6	22.4	14.1	8.9	5.6	3.5

Power Supplies

See fixture and power supply instructions & spec sheet for wiring information. Dimming possible in select models - view Luminii website for list of compatible dimmers.

For use with Warm Dim

Ordering Code - Universal Dimming Power Supplies 0.1% 120VAC - 277VAC

MODEL	INPUT CONTROL	WATTAGE	OUTPUT
PS-Power Supply, 120-277VAC	UNI - 0-10V Dimming (0.1%), Phase Dimming (0.1%)	30 - 30 Watts 60 - 60 Watts 96 - 96 Watts 3x96 - 3x96 Watts	24 - 24 VDC

Compatibility: View a complete list of compatible dimmers on the PS-UNI product page.

0-10V - 0.1% dimming
MLV/ELV/TRIAC - 0.1% dimming, consult dimming compatibility chart

MODELS	PS-UNI-30W	PS-UNI-60W	PS-UNI-96W	PS-UNI-3X96W
Length	6.50"	7.40"	8.66"	11.85"
Width	3.73"	3.73"	3.73"	4.32"
Depth	1.61"	1.61"	1.61"	1.81"

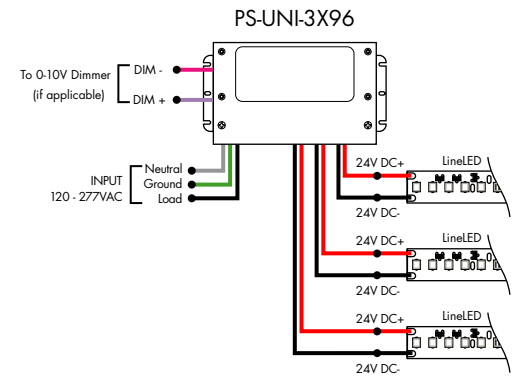
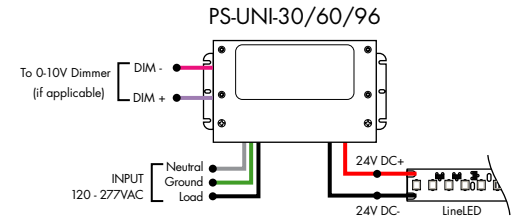

Ordering Code - DALI 2 Dimming Power Supplies 0.1% 120VAC - 277VAC

MODEL	INPUT CONTROL	ENVIRONMENT	WATTAGE	OUTPUT
PS-Power Supply, 120-277VAC	DALI2-DT6 - DALI2 DT6 (0.1%)	D - Dry	96-96 Watts	24 - 24 VDC

Model	96W
Length	14.40"
Width	5.20"
Depth	2.60"

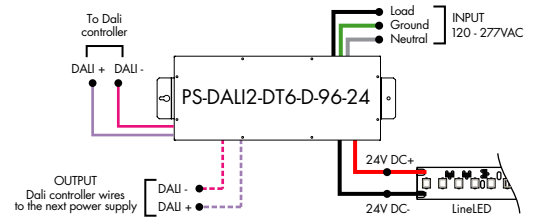

Power Supplies

See fixture and power supply instructions & spec sheet for wiring information. Dimming possible in select models - view Luminii website for list of compatible dimmers.

For use with Warm Dim

Ordering Code - 0-10V Dimming Power Supplies 0.1% 120VAC - 277VAC

MODEL	INPUT CONTROL	ENVIRONMENT	WATTAGE	OUTPUT
PS - Power Supply, 120-277VAC	010V-LIN - 0-10V Dimming (0.1%), Linear 010V-LOG - 0-10V Dimming (0.1%), Logarithmic	D - Dry	96-96 Watts 3x96-3x96 Watts	24-24 VDC

MODELS	96W	3X96
Length	14.40"	15.00"
Width	5.20"	6.62"
Depth	2.60"	4.45"

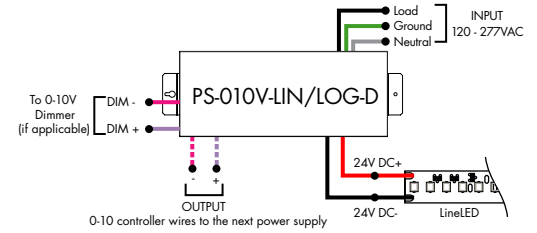

PS-010V-LIN/LOG-D-3X96

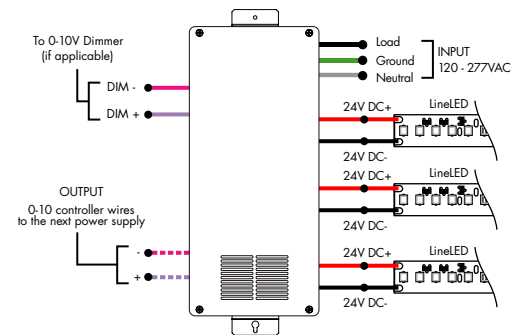

Ordering Code - Athena 0-10V LED Driver

MODEL	INPUT CONTROL	ENVIRONMENT	WATTAGE	OUTPUT	FEATURE
PS - Power Supply, 120-277VAC	010V-LIN - 0-10V Dimming (0.1%), Linear 010V-LOG - 0-10V Dimming (0.1%), Logarithmic	D - Dry	96-96 Watts	24-24 VDC	AWNR - Athena Wireless Node

MODELS	96W
Length	14.40"
Width	5.20"
Depth	2.60"

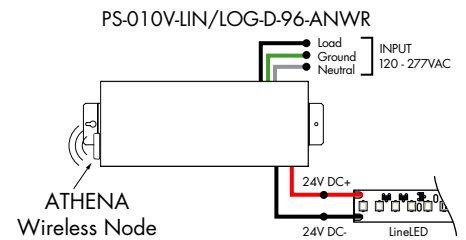

Power Supplies

See fixture and power supply instructions & spec sheet for wiring information. Dimming possible in select models - view Luminii website for list of compatible dimmers.

For use with Tunable White

Ordering Code - DALI2 Dimming Power Supplies 0.1% 120VAC - 277VAC

MODEL	INPUT CONTROL	ENVIRONMENT	WATTAGE	OUTPUT
PS - Power Supply, 120-277VAC	DALI2-DT8 - DALI DT8 Tunable White (0.1%)	D - Dry	96 - 96 Watts	24 - 24 VDC

MODELS	96W
Length	14.40"
Width	5.20"
Depth	2.60"

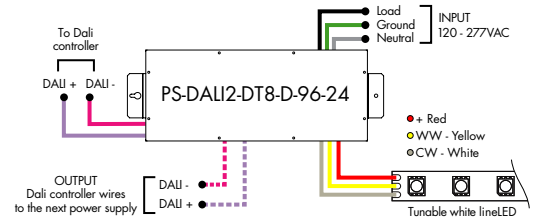

Ordering Code - Athena DALI2 Dimming Power Supplies 0.1% 120VAC - 277VAC

MODEL	INPUT CONTROL	ENVIRONMENT	WATTAGE	OUTPUT	FEATURE
PS - Power Supply, 120-277VAC	DALI2-DT8 - DALI DT8 Tunable White (0.1%)	D - Dry	96 - 96 Watts	24 - 24 VDC	AWN - Athena

MODELS	96W
Length	14.40"
Width	5.20"
Depth	2.60"

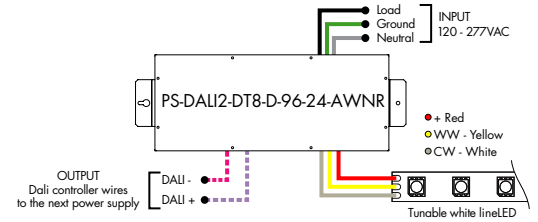

Ordering Code - DALI2 Dimming Power Supplies 0.1% 120VAC - 277VAC - for Dim-to-Warm functionality with Tunable White Output

MODEL	INPUT CONTROL	ENVIRONMENT	WATTAGE	OUTPUT
PS - Power Supply, 120-277VAC	DALI2-WD - DALI2 DT6 Warm Dim (0.1%)	D - Dry	96 - 96 Watts	24 - 24 VDC

MODELS	96W
Length	14.40"
Width	5.20"
Depth	2.60"

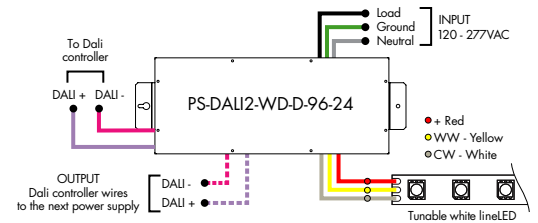

Ordering Code - DMX Dimming Power Supplies 0.1% 120VAC - 277VAC

MODEL	INPUT CONTROL	ENVIRONMENT	WATTAGE	OUTPUT
PS - Power Supply, 120-277VAC	DMX - DMX (0.1%)	D - Dry	96 - 96 Watts 3X96 - 3X96 Watts	24 - 24 VDC

MODELS	96W	3X96
Length	14.40"	15.00"
Width	5.20"	6.62"
Depth	2.60"	4.56"

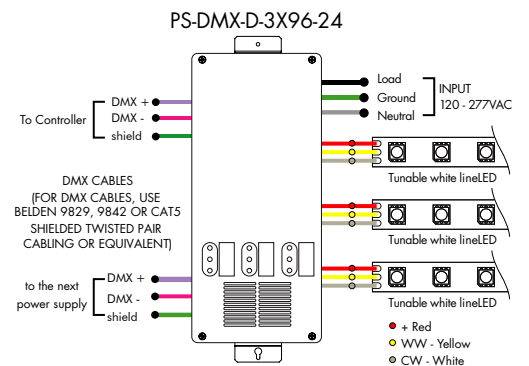
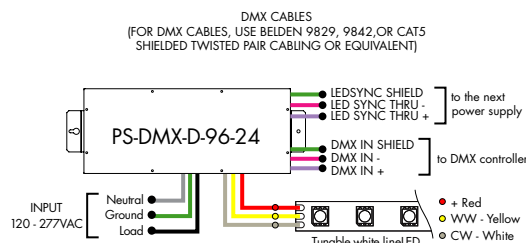

Power Supplies

See fixture and power supply instructions & spec sheet for wiring information. Dimming possible in select models - view Luminii website for list of compatible dimmers.

For use with Tunable White

Ordering Code - VintageDim® 0-10V Dimming Power Supplies 0.1% 120VAC - 277VAC

MODEL	INPUT CONTROL	ENVIRONMENT	WATTAGE	OUTPUT
PS - Power Supply, 120-277VAC	010V-WD - 0-10V Dimming (0.1%), Standard Warm Dim Curve (with Tunable White LED) 010V-TW - 0-10V Dimming (0.1%), Two Channel Control, Brightness and CCT1-CCT2 Ratio 010V-2CH - 0-10V Dimming (0.1%), Two Channel Control, LED1 Brightness and LED2 Brightness 010V-WDX - 0-10V Dimming (0.1%), Customizable Warm Dim Curve (with Tunable White LED)	D-Dry	96-96 Watts 3X96 - 3x96 Watts ¹	24-24 VDC

1 - 3x96 is only available with input control options 010V-WD and 010V-TW

MODELS	96W	3X96
Length	14.40"	15.00"
Width	5.20"	6.62"
Depth	2.60"	4.56"

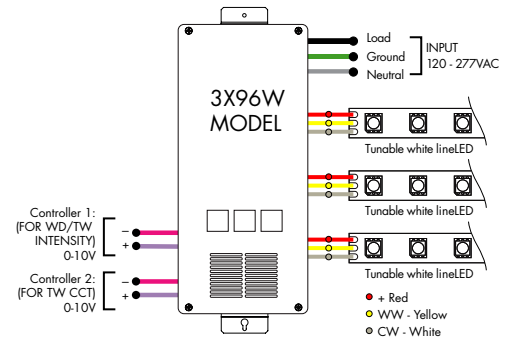
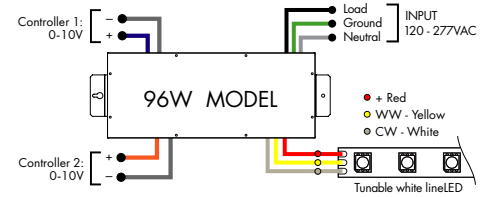

Ordering Code - Athena VintageDim® 0-10V Power Supply 0.1% 120VAC - 277VAC - for Dim-to-Warm functionality with Tunable White Output

MODEL	INPUT CONTROL	ENVIRONMENT	WATTAGE	OUTPUT	FEATURE
PS - Power Supply, 120-277VAC	010V-WD - 0-10V Dimming, Standard Warm Dim Curve (with Tunable White LED)	D-Dry	96-96 W	24-24 VDC	AWN - Athena

MODELS	96W
Length	14.40"
Width	5.20"
Depth	2.60"

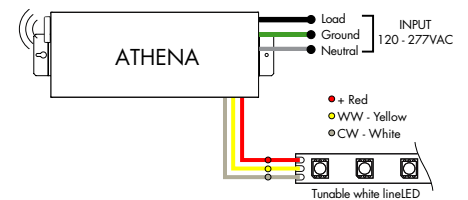

Ordering Code - Athena VintageDim® 0-10V Two Channel LED Driver, 0.1% 120VAC - 277VAC

MODEL	INPUT CONTROL	ENVIRONMENT	WATTAGE	OUTPUT	FEATURE
PS - Power Supply, 120-277VAC	010V-2CH - 0-10V Dimming Two Channel Control, LED1 Brightness and LED2 Brightness	D-Dry	96-96 W	24-24 VDC	AWN - Athena

MODELS	96W
Length	14.40"
Width	5.20"
Depth	2.60"

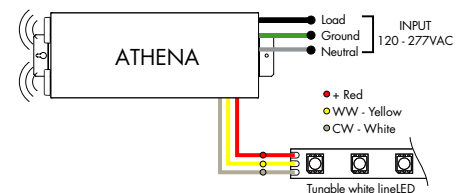

Power Supplies

See fixture and power supply instructions & spec sheet for wiring information. Dimming possible in select models - view Luminii website for list of compatible dimmers.

For use with RGB/RGBW

Ordering Code - Universal Dimming Power Supplies 0.1% 120VAC - 277VAC

MODEL	INPUT CONTROL	WATTAGE	OUTPUT
PS - Power Supply, 120-277VAC	UNI - 0-10V Dimming (0.1%), Phase Dimming (0.1%)	30 - 30 Watts 60 - 60 Watts 96 - 96 Watts 3x96 - 3x96 Watts	24 - 24 VDC

MODELS	PS-UNI-30W	PS-UNI-60W	PS-UNI-96W	PS-UNI-3X96W
Length	6.50"	7.40"	8.66"	11.85"
Width	3.73"	3.73"	3.73"	4.32"
Depth	1.61"	1.61"	1.61"	1.81"

REQUIRES A CONTROLLER AND A DECODER TO WORK PROPERLY

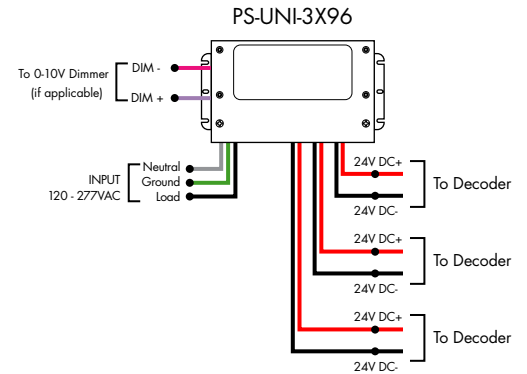
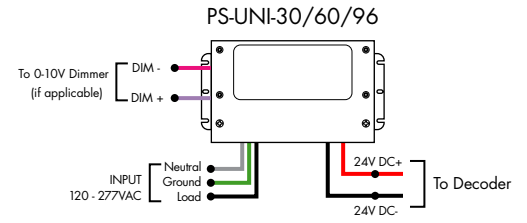

For use with RGB/RGBW

Ordering Code - DMX Dimming Power Supplies 0.1% 120VAC - 277VAC

MODEL	INPUT CONTROL	ENVIRONMENT	WATTAGE	OUTPUT
PS - Power Supply, 120-277VAC	DMX - DMX (0.1%)	D - Dry	96 - 96 Watts 3X96 - 3X96 Watts	24 - 24 VDC

MODELS	96W	3X96
Length	14.40"	15.00"
Width	5.20"	6.62"
Depth	2.60"	4.56"

DMX CABLES (FOR DMX CABLES, USE BELDEN 9829, 9842 OR CAT5 SHIELDED TWISTED PAIR CABLING OR EQUIVALENT)

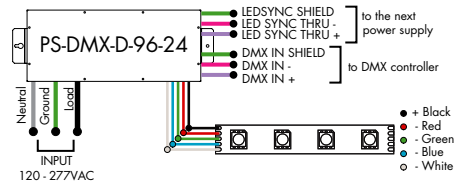

PS-DMX-D-3X96-24

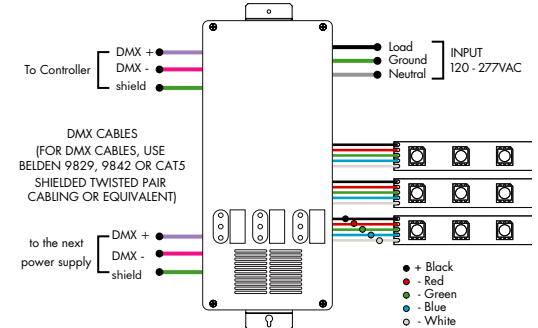

For use with RGB/RGBW/Pixel

Ordering Code - Non-Dimming Power Supply 120VAC - 277VAC

MODEL	INPUT CONTROL	ENVIRONMENT	WATTAGE	OUTPUT
PS - PSV Series	ND - Non Dimming	D - Dry	96 - 96 Watts	24 - 24 VDC

MODELS	96W
Length	14.40"
Width	5.20"
Depth	2.60"

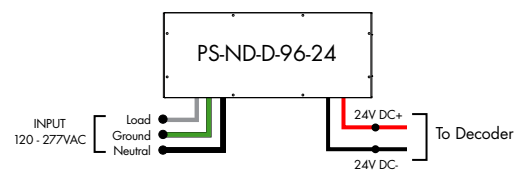

REQUIRES A CONTROLLER AND A DECODER TO WORK PROPERLY

Controllers and Decoders

For use with Tunable White Power Supplies



ORDERING CODE

MODEL

DTW-MC

DTW-MC - Tunable White controller

Tunable White wall-mount controller controls lighting fixtures, wireless control of TW lighting fixture. Fits in any standard US switch box. Includes all the outputs in the back of the controller.

Features

- Switch & dimming control function, control range > 20M.
- Smooth transition between light levels.
- Separately operate dimming and color temperature functions.
- Able to control 1 zone with endless receivers. Each receiver can maximally be controlled by 8 remotes.
- Power, temperature color and dimming functions operated by push button after receivers are connected.

Operating Voltage

3V DC battery

Color Parameters

- Brightness
- Saturation
- Fading

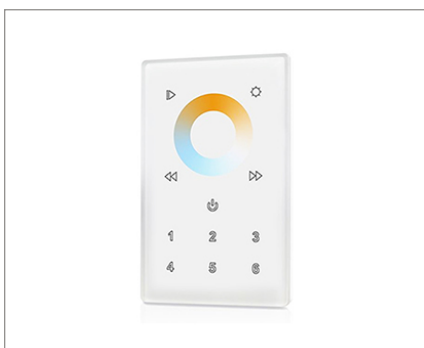

ORDERING CODE

MODEL

TW-DMX

TW-DMX - DMX controller

Tunable White DMX wall-mount controller is a fully touch sensitive controller designed in accordance with standard dimming protocol DMX512. Offers fast and accurate color temperature adjustment and brightness dimming of natural white, warm white and cold white. Designed with a touch color wheel, the DMX512 controller can adjust color temperature and brightness for all white LEDs smoothly and accurately. The DMX controller can control 1 zone with endless decoders.

Features

- 1 zone
- 6 color scenes
- DMX Control
- Touch Sensitive Glass Surface
- Dimming and Speed Control
- Memory Function
- Easily Fits Standard US Switch Boxes

Operating Voltage

12 - 24V DC

Color Parameters

- Brightness
- Saturation
- Primary colors
- Fading
- Color changing speed



ORDERING CODE

MODEL

SLD-DIMTW

SLD-DIMTW - Tunable white LED dimming module

The SLD DimTW is a constant voltage warm dimming LED dimming module. The unique dimming module accepts 0-10V control and mimics a smooth, incandescent dimming curve.

Features

- Flicker free 0-100% dimming
- High efficiency up to 97%
- High precision dimming ratio:>1:1000
- Fully isolated plastic housing
- Comply with EN55015 and FCC part 15 without additional input filter and capacitors
- compact size, high reliability
- 3 years warranty

Operating Voltage

8-48 VDC

Controllers and Decoders

For use with Tunable White, RGB/RGBW Power Supplies



Translates controller DMX512 programs for RGB and white LED strips.
 Unique DMX address for the decoder can be set easily and displayed by the numeric display on the case. Changing and resetting the DMX address requires manual input.
 Use power repeater to expand output.

Operating Voltage

12-36 VDC

Power Capacity

up to 96W at 24V

Operating Temperature Range

from -4°F to +122°F in case

ORDERING CODE

MODEL

DDMX-RGBW

DDMX-RGBW - DMX decoder



The RGBW receiver is easily paired with controller by the click of a button. Receiver can be reset to factory settings at any time.

Each receiver can store one static RGB color, one color sequence, and one brightness setting for the white LED strip. Receivers assigned to the same scene within the same zone will have the same LED static color and color sequence.

Operating Voltage

12-36 VDC

Power Capacity

up to 96W at 24V

Operating Temperature Range

from -4°F to +122°F in case

ORDERING CODE

MODEL

RGBW-RC-R

RGBW-RC-R - RGBW receiver



Extends identical signal when connected in series to an RGBW LED control system. The RGBW signal repeater works with Luminii RGB and RGBW controllers, receivers, and decoders.

RGBW signal can be extended indefinitely when adequate power supply (not included) is connected to the system.

Operating Voltage

12-36 VDC

Power Capacity

up to 96W at 24V

Operating Temperature Range

from -4°F to +122°F in case

ORDERING CODE

MODEL

RGBW-SR

RGBW-SR - RGBW signal repeater

Controllers and Decoders

For use with RGB/RGBW Power Supplies



ORDERING CODE

MODEL

RGBW-MC3

RGBW-MC3 - 4-zone RGBW controller

Easy to operate wireless interface suitable for static or color changing scenes. Control 4 different color zones separately or at the same time. RGBW receiver (RGBW-RC-R) required for operation. Assign multiple receivers per zone to cover a large area.

Color wheel enables highly stable and sensitive color control functionality. Create your own color changing sequences with ease and flexibility.

Power

qty 3 AAA batteries

Scenes

up to 4 unique zones

Signal

Wireless (RF)

Energy Saving

Deactivates after 10 seconds of inactivity

Color Parameters

- Brightness
- Saturation
- Primary colors
- Speed of color changing sequence
- Fading

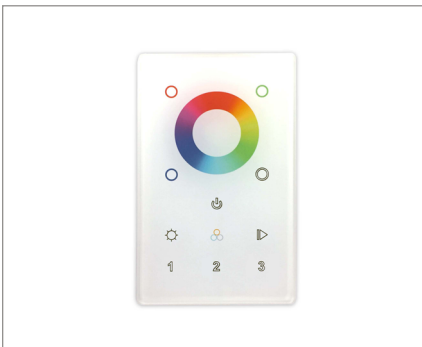

ORDERING CODE

MODEL

ZONES

COLOR

DMX-DMX Controller	-	3Z - Three Zone 1Z - One Zone	-	RGBW - Red, Green, Blue, & White
-----------------------	---	----------------------------------	---	-------------------------------------

DMX-DMX Controller 3Z - Three Zone 1Z - One Zone RGBW - Red, Green, Blue, & White

DMX /Wireless RGB-W wall-mount controller controls DMX lighting fixtures, wireless control of RGB-W lighting fixture or use both simultaneously. Fits in any standard US switch box. Includes all the outputs in the back of the controller.

Control brightness levels with a single touch, personalize and memorize 3 different scenes, and even create 3 variations of white.

Features

- 2 in 1 in-Wall Controller: DMX Control or Wireless RGB-W
- 65,000 Color Options, Dimming and Speed Control
- Memory Function
- 50 Foot Wireless Range
- Easily Fits Standard US Switch Boxes
- Touch Sensitive Glass Surface
- Includes 10 Built in Programs, or Create and Play Your Own

Operating Voltage

12 - 24V DC

Color Parameters

- Brightness
- Saturation
- Primary colors
- Fading
- Color changing speed

For use with Tunable White, RGB/RGBW, Pixel Power Supplies

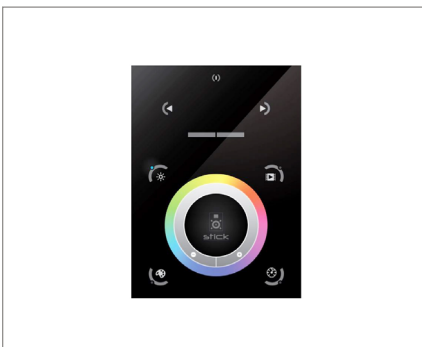

ORDERING CODE

MODEL

TSDMX-E

TSDMX-E - Touchscreen DMX controller

Programmable advanced DMX512 lighting controller featuring a touch-screen interface. Operates as stand alone controller or integrated with most architectural lighting control systems. Can controller endless DMX512 enabled devices.

Mounts to standard single or dual gang wall box with the included power supply inside the junction box. Terminal block design for power and data connections.

Features

- Sleek glass design which sits 0.43" from the wall
- Graphical color display to show selected environment
- Color/dimmer/speed palette
- Color temperature mixing
- Touch sensitive buttons. No mechanical parts
- Touch sensitive wheel allows for accurate color selection
- Multi-zone microSD memory
- Multi-room control with 500 scenes, 10 zones
- 1024 DMX channels. Control 340 RGB fixtures
- USB & Ethernet connectivity for programming and control

Power Supply

7 VDC (included)

Programmability

PC, Mac, Tablet, Smartphone

Output Signal

DMX512 (1024 channels)

Color Parameters

- Brightness
- Saturation
- Speed of color changing sequence
- Fading / dimming / brightness

Controllers and Decoders

For use with Tunable White, RGB/RGBW Power Supplies

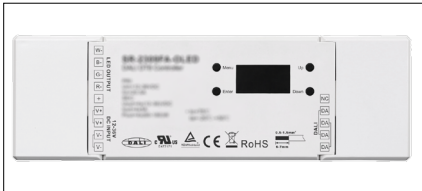

ORDERING CODE

MODEL

DALI2-DT8-RGBW

DALI2-DT8-RGBW - DALI-2 RGBW Decoder

A 4-channel DALI2 DT8 decoder designed to control RGB, RGBW, and TW LED fixtures, featuring adjustable color temperature and customizable lumen output.

Voltage/Frequency
12-36VDC

Max Output Power
4 output channels, 60-180W each

Max Output Current
4 output channels, max of 5A each

Ambient Operating Temperature Range
-20 to 50°C

Environment
Dry (IP20)



ORDERING CODE

MODEL

DDMX-5CH-RDM-PRO

DDMX-5CH-RDM-PRO - DMX512 Decoder

DMX512 decoder with RDM functionality features 5 PWM output channels with common anode. High PWM output frequency range allows the product to be used in HD video conferencing spaces. All DMX products to be installed per DMX512 Standard.

Power

96 Watt

Inputs

RJ45, XLR-5Pin, Terminal Block

DMX Channels

1 to 5 settable

PWM Output Resolution Ratio

8 or 16 bit

PWM Output Frequency

500Hz - 30KHz

Output Dimming Curve Gamma Value

0.1 ~ 9.9



ORDERING CODE

MODEL

RGBW-WI-R

RGBW-WI-R - WIFI generator

RGBW-WI-R creates a local network that enables any electronic device (phone, tablet, etc.) to control the RGB/W strip connected to a RGBW-RC-R receiver.

The control functions are achieved through a free application download for Android and iOS devices called REALCOLOR.

Operating Voltage

12-36 VDC

Power Supply

PI-130-24 (included)

Operating Temperature Range

from -4°F to +122°F in case

For use with Pixel Power Supplies

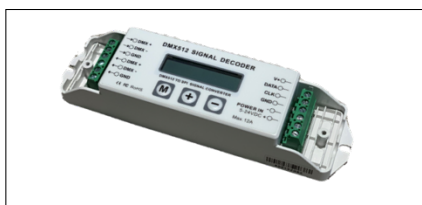

ORDERING CODE

MODEL

SR-DMX-SPI

SR-DMX-SPI - Smart Pixel Decoder

The SR-DMX-SPI is a smart LED pixel decoder that controls RGB/RGBW pixel LED strips with SPI signal. Designed with an OLED backlit panel, the pixel controller allows for easy configuration of most settings. Four push buttons are available for control of the LED functions.

*For pixel only.

Features

- 2 in 1 in-Wall Controller: DMX Control or Wireless RGB-W
- SPI signal output for RGB/RGBW pixel light control
- DMX512 controllable and RF/WIFI remote controllable
- Capable of addressing up to 1020 RGB pixels & 765 RGBW pixels
- OLED panel allows for easy configuration

Operating Voltage

12 - 36V DC

Power capacity

up to 96W at 24V

Operating temperature range

from -4°F to +122°F in case