

Features

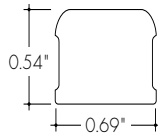

- 24VDC Class 2 fixtures made to order up to 144". Fixtures can be linked up to 37' depending on output
- Suitable for grazer, surface mount, architectural reveals, handrail, and accent lighting applications.
- Class two listed for damp locations.
- Dot free even illumination with frosted lens
- Proprietary strong bond solder method handles up to 50 lbs of pull force on wire leads and connectors.
- Average Life (L70): 50,000hrs
- 7 year warranty
- Warm Dim follows the incandescent dimming curve and is compatible with MLV, ELV, and Incandescent dimmers.
- Tunable White allows individual control of CCT and output, can be paired with Vintage Dim power supply for warm dim effect
- RGB offers balanced output across the color gamut and a true white with RGBW
- Smart Pixel allows for infinite color combinations with cascading and chasing effects

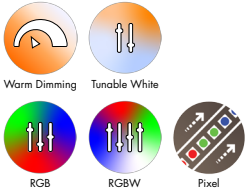

Finish Options (see page 3 for additional information)

- Powder Coat** Black Bronze White
- Premium** Matte Black Warm Nickel Aged Brass
- Polished Gold Chrome



Technical Information

| TYPE | Warm Dim | | | Tunable White | | | RGB | | RGBW | | Pixel | | |
|---|--|-----------|-----------------------------|-----------------------------|-----------|-----------------------------|-----------------------------|----------------------------|-----------------------------|-----------|-----------------------------|-----------------------------|-----------------------------|
| | WD51 (18K-30K) | | | TW51 (27K-65K) | | | RGB42 | | RGBW36 | | RGBX18 | RGBWX18 | |
| OUTPUT OPTIONS | SO | HO | VHO | SO | HO | VHO | SO | HO | SO | HO | SO | SO | |
| Lumens Output (3000K) <small>[All On w/ Narrow Beam Grazer]</small> | 106 lm/ft | 223 lm/ft | 317 lm/ft | 236 lm/ft | 293 lm/ft | 396 lm/ft | 172 lm/ft | 253 lm/ft | 173 lm/ft | 287 lm/ft | 138 lm/ft | 209 lm/ft | |
| Average Power Consumption <small>(for a 4" section)</small> | 2.3 W/ft | 4.7 W/ft | 6.9 W/ft | 4.4 W/ft | 5.4 W/ft | 7.6 W/ft | 4.5 W/ft | 8.3 W/ft | 4 W/ft | 7.6 W/ft | 4.5 W/ft | 5.7 W/ft | |
| Efficacy | 46 lm/W | 47 lm/W | 46 lm/W | 54 lm/W | 54 lm/W | 52 lm/W | 38 lm/W | 30 lm/W | 43 lm/W | 38 lm/W | 31 lm/W | 37 lm/W | |
| Max Run Length <small>(in series)</small> | 37 ft | 22 ft | 15 ft | 27.9 ft | 22 ft | 15 ft | 28ft | 14ft | 26ft | 13ft | 30ft | 20ft | |
| Ambient Operating Temperature Range* | -4°F - 122°F (-20°C - 50°C) | | -4°F - 113°F (-20°C - 45°C) | -4°F - 122°F (-20°C - 50°C) | | -4°F - 104°F (-20°C - 40°C) | -4°F - 122°F (-20°C - 50°C) | -4°F - 95°F (-20°C - 35°C) | -4°F - 122°F (-20°C - 50°C) | | -4°F - 104°F (-20°C - 40°C) | -4°F - 122°F (-20°C - 50°C) | -4°F - 122°F (-20°C - 50°C) |
| Control/Dimming Protocol | 0-10V, DALI, DALI2, MLV (Triac), ELV, Incandescent | | | 0-10V, DMX, DALI-DT8 | | | DMX, DALI-DT8 | | DMX, DALI-DT8 | | SPI Protocol UCS 2903 | SPI Protocol UCS 2904 | |

*Ambient Operating Temperature Range to maintain L70 of 50k+ hours in normal mounting conditions for the fixture. Exceeding Ambient Operating Temperature Range may result in decreased life/output. Consult Technical Support for specific inquiries.

Warm Dim (WD51)

| CCT | Multiplier <small>(ref. - 18K30K)</small> | TM-30 | | | |
|--------|--|-------|----------------|----------------|----------------|
| | | CRI | R _f | R _g | R ₉ |
| 18K24K | 0.90 | 92 | 85 | 91 | 86 |
| | | 96 | 95 | 104 | 97 |
| 18K27K | 0.97 | 92 | 85 | 91 | 86 |
| | | 96 | 95 | 104 | 96 |
| 18K30K | 1.00 | 92 | 85 | 91 | 86 |
| | | 95 | 95 | 104 | 90 |

Tunable White (TW51)

| CCT | Multiplier <small>(ref. - 27K65K)</small> | TM-30 | | | |
|--------|--|-------|----------------|----------------|----------------|
| | | CRI | R _f | R _g | R ₉ |
| 18K30K | 0.78 | 92 | 85 | 91 | 86 |
| | | 95 | 93 | 106 | 98 |
| 27K65K | 1.00 | 97 | 94 | 104 | 95 |
| | | 97 | 95 | 103 | 93 |
| 4200K | 1.00 | 96 | 93 | 105 | 95 |
| | | 91 | 90 | 101 | 63 |

RGBW (3000K)

| Tape | TM-30 | | | |
|---------|-------|----------------|----------------|----------------|
| | CRI | R _f | R _g | R ₉ |
| RGBW36 | 95 | 93 | 106 | 84 |
| RGBWX18 | 93 | 91 | 99 | 64 |

Dominant Wavelength

| Color | RGB42/ RGBW36 | RGBX18/ RGBWX18 |
|-------|------------------|--------------------|
| Red | 620nm | 621nm |
| Green | 525nm | 519nm |
| Blue | 467nm | 465nm |

Ordering Code

| MODEL | LENGTH ¹ | OUTPUT ² | CCT | LENS | MOUNTING | FINISH ⁴ | FEED POSITION LEFT ⁶ | FEED POSITION RIGHT ⁶ | ACCESSORIES |
|---------------------------|---------------------------|-----------------------------|------------------------|-------------------------|--|--|---|---|---|
| KM-BABA -Kendo M BABA | 12"-144" 2" increments | WD51SO - Standard | 18K24K - 1800K - 2400K | GR - Narrow Beam Grazer | FC - Fixed Clip A - Adjustable Hinge Mounting FC45 - Fixed Clip, 45° MAG - Magnetic | POWDER COAT BK - Black BZ - Bronze WH - White | WIRE LEADS (72") LWE - Wire End Feed LWB - Wire Back Feed LWSA - Wire Side A Feed LWSB - Wire Side B Feed LNPF - No Power Feed | WIRE LEADS (72") RWE - Wire End Feed RWB - Wire Back Feed RWSA - Wire Side A Feed RWSB - Wire Side B Feed RNPF - No Power Feed | --- N/A, leave blank BLS - Blade louver, Silver BLBK - Blade louver, Black BLWH - Blade louver, White GSS - Glare shield, Silver GSBK - Glare shield, Black GSWH - Glare shield, White |
| | | WD51HO - High | 18K27K - 1800K - 2700K | | | | | | |
| | WD51VHO - Very High | 18K30K - 1800K - 3000K | | | | | | | |
| | TW51SO - Standard | 18K30K - 1800K - 3000K | | | | | | | |
| 12"-144" 2" increments | TW51HO - High | 27K65K - 2700K - 6500K | CLR - Color | | | | | | |
| | TW51VHO - Very High | | | | | | | | |
| 12"-144" 2" increments | RGBW36SO - Standard | CLR - Color | | | | | | | |
| | RGBW36HO - High | | | | | | | | |
| 12"-144" 2" increments | RGB42SO - Standard | | | | | | | | |
| | RGB42HO - High | | | | | | | | |
| 12"-144" 4" increments | RGBWX18SO - Standard | PXSPI - Smart Pixel Control | | | | | | | |
| | RGBX18SO - Standard | | | | | | | | |

1 - Custom lengths and increments are available, please consult Inside Sales with specific request.

2 - Warm Dim and Tunable White options can be used to comply with Title 24 JAB at max brightness depending on Lens selection, see multiplier charts to calculate specific efficacy.

3 - Finishes may have extended lead times. Custom RALs are available, please consult Inside Sales with specific request.

4 - Polished Gold finishes and Chrome finishes have a maximum fixture length of 96".

5 - LNPF - RNPF is not a valid configuration option

Powerfeeds and Connectors

Power Feed Position Options and Orientation

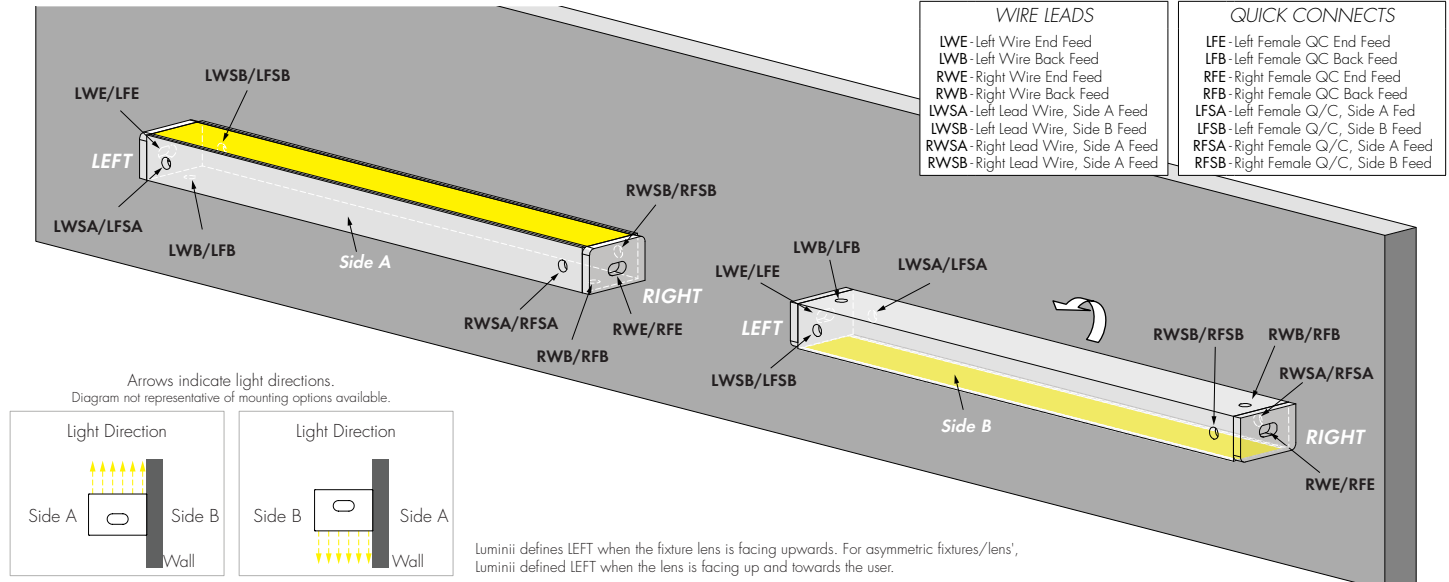

Linking and Extension Cable Options

For use with Warm Dim (WD51):

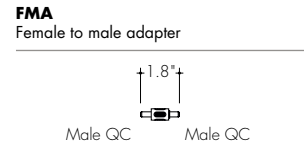
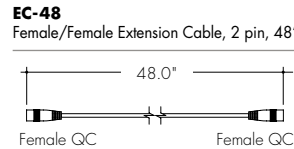
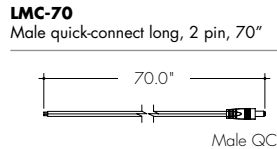
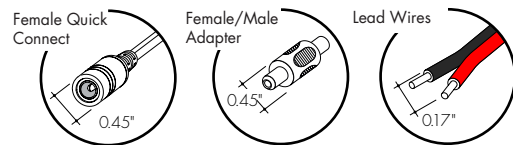

For use with Tunable White (TW51), RGB Pixel (RGBX18) and RGBW Pixel (RGBWX18):

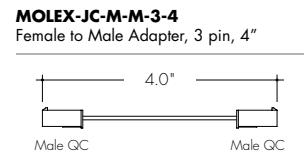
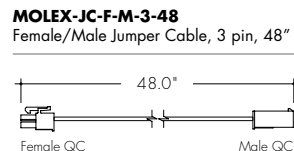
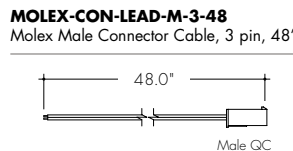
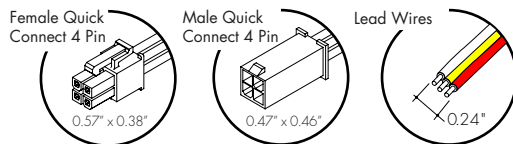

For use with RGB (RGB42):

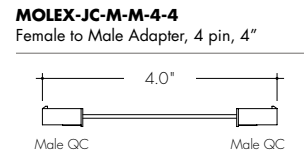
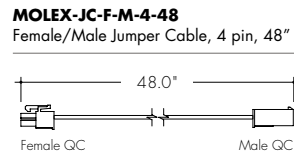
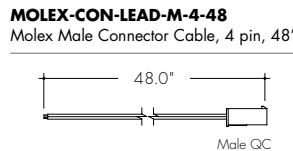
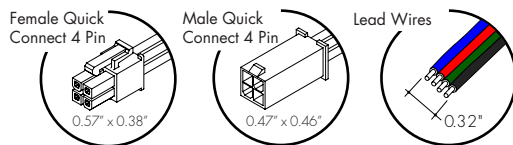

For use with RGBW (RGBW36):

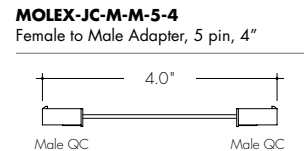
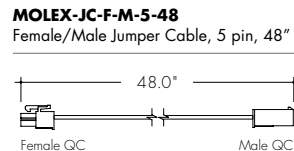
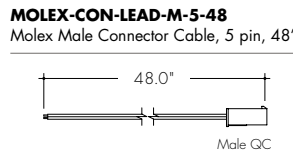
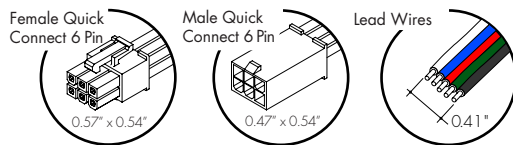

Sample Layout

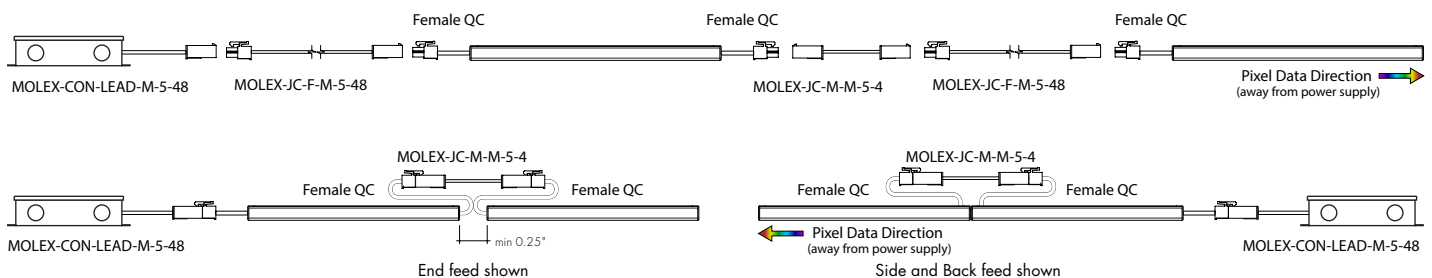

Product Dimensions

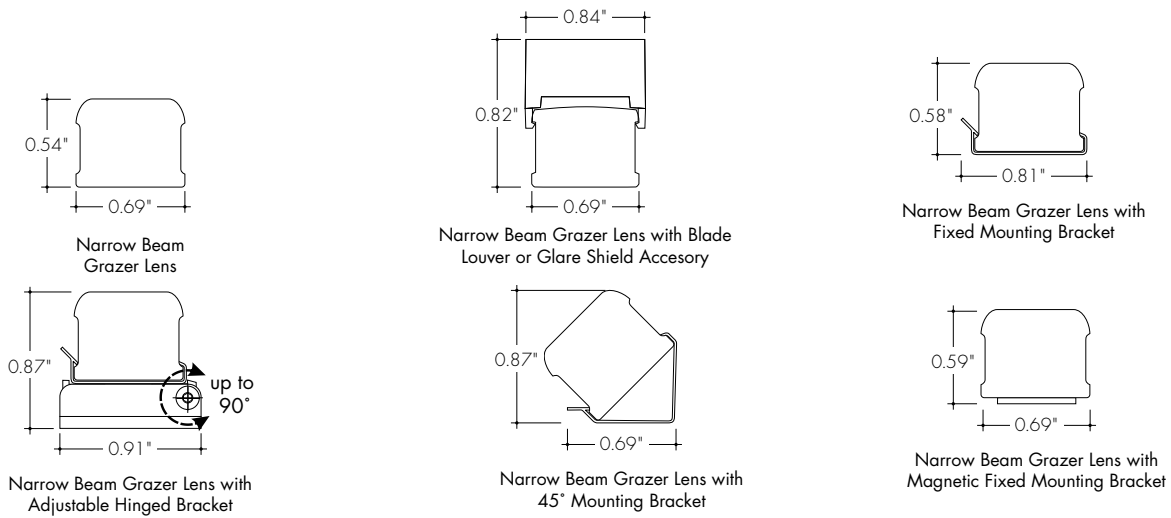

Finish Options

- Finish options are available in a wide variety, allowing for complete customization of style and aesthetic.
- Finishes may have extended lead times and price adder.
- Polished Gold and Chrome finishes have a maximum fixture length of 96".
- Custom RALs are available, please consult Inside Sales with specific request.

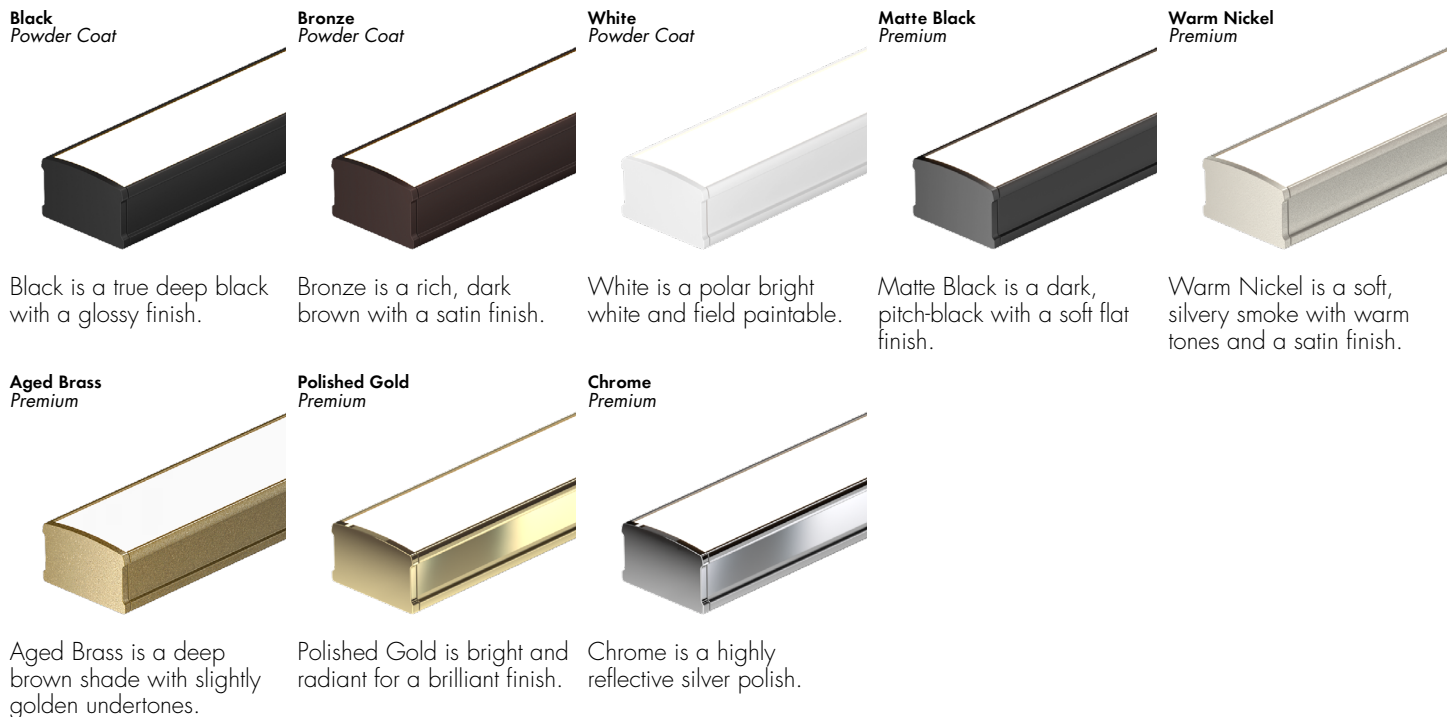

Light Transmission and Dotting

| Output Options | Lens/Accessory | | | |
|--------------------------------|--------------------|-----|-----|----|
| | Narrow Beam Grazer | | | |
| Dimming Level | 100% | 50% | 10% | 1% |
| WD51SO | CD | CD | CD | CD |
| WD51HO | CD | CD | CD | CD |
| WD51VHO | CD | CD | CD | CD |
| TW51SO (All On) | CD | CD | CD | CD |
| TW51HO (All On) | CD | CD | CD | CD |
| TW51VHO (All On) | CD | CD | CD | CD |
| TW51SO (1 CH) | CD | CD | CD | CD |
| TW51HO (1 CH) | CD | CD | CD | CD |
| TW51VHO (1 CH) | CD | CD | CD | CD |
| RGBW36SO | CD | CD | CD | CD |
| RGBW36HO | CD | CD | CD | CD |
| RGB42SO | CD | CD | CD | CD |
| RGB42HO | CD | CD | CD | CD |
| RGBWX18SO | CD | CD | CD | CD |
| RGBX18SO | CD | CD | CD | CD |
| Transmission Percentage | 100% | | | |

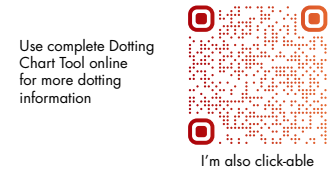
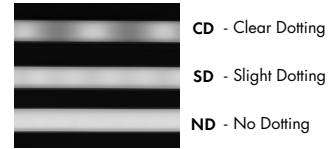

Accessory Options

LV-GS-KMSC-24-XX

Glare Shield reduces glare at high angle, field cuttable. Also available with complete fixture, use ordering code **-GSXX**

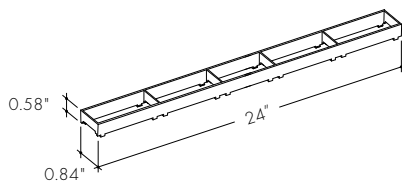

LV-BL-KMSC-24-XX

Blade Louver reduces glare at high angle in two directions. Also available with complete fixture, use ordering code **-BLXX**

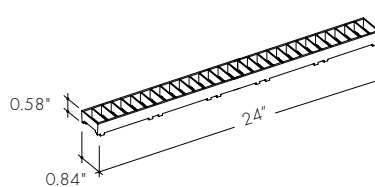

LVSP-4T-BK

Low Voltage, 4 Terminal Splice Box, Black, IP20

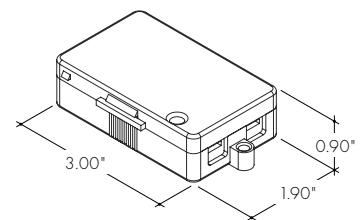

| XX | Color |
|----|--------|
| WH | White |
| BK | Black |
| SL | Silver |

Power Consumption

Please visit the link/QR code below to access the Luminii Power Consumption Chart tool on our website.

There you will be able to select your fixture, output, and desired power feed to get a full power consumption table.



I'm also click-able

Desired Nominal Length: _____

Desired Output: _____

Desired CCT: _____

Voltage Drop Calculator

The below chart assumes nominal voltage of 24 Volts and a Voltage Drop Allowance of 3% through the wire

| Wattage [W] | Wire Length From Power Supply to Start of Run [ft] | | | | | | |
|-------------|--|--------|--------|--------|--------|--------|--------|
| | 12 AWG | 14 AWG | 16 AWG | 18 AWG | 20 AWG | 22 AWG | 24 AWG |
| 5 | 1088.2 | 684.4 | 430.3 | 270.6 | 170.2 | 107.1 | 67.3 |
| 10 | 544.1 | 342.2 | 215.1 | 135.3 | 85.1 | 53.5 | 33.7 |
| 15 | 362.7 | 228.1 | 143.4 | 90.2 | 56.7 | 35.7 | 22.4 |
| 20 | 272.0 | 171.1 | 107.6 | 67.7 | 42.6 | 26.8 | 16.8 |
| 25 | 217.6 | 136.9 | 86.1 | 54.1 | 34.0 | 21.4 | 13.5 |
| 30 | 181.4 | 114.1 | 71.7 | 45.1 | 28.4 | 17.8 | 11.2 |
| 35 | 155.5 | 97.8 | 61.5 | 38.7 | 24.3 | 15.3 | 9.6 |
| 40 | 136.0 | 85.5 | 53.8 | 33.8 | 21.3 | 13.4 | 8.4 |
| 45 | 120.9 | 76.0 | 47.8 | 30.1 | 18.9 | 11.9 | 7.5 |
| 50 | 108.8 | 68.4 | 43.0 | 27.1 | 17.0 | 10.7 | 6.7 |
| 55 | 98.9 | 62.2 | 39.1 | 24.6 | 15.5 | 9.7 | 6.1 |
| 60 | 90.7 | 57.0 | 35.9 | 22.6 | 14.2 | 8.9 | 5.6 |
| 65 | 83.7 | 52.6 | 33.1 | 20.8 | 13.1 | 8.2 | 5.2 |
| 70 | 77.7 | 48.9 | 30.7 | 19.3 | 12.2 | 7.6 | 4.8 |
| 75 | 72.5 | 45.6 | 28.7 | 18.0 | 11.3 | 7.1 | 4.5 |
| 80 | 68.0 | 42.8 | 26.9 | 16.9 | 10.6 | 6.7 | 4.2 |
| 85 | 64.0 | 40.3 | 25.3 | 15.9 | 10.0 | 6.3 | 4.0 |
| 90 | 60.5 | 38.0 | 23.9 | 15.0 | 9.5 | 5.9 | 3.7 |
| 96 | 56.7 | 35.6 | 22.4 | 14.1 | 8.9 | 5.6 | 3.5 |

Power Supplies

See fixture and power supply instructions & spec sheet for wiring information. Dimming possible in select models - view Luminii website for list of compatible dimmers.

For use with Warm Dim

Ordering Code - Universal Dimming Power Supplies 0.1% 120VAC - 277VAC

| MODEL | INPUT CONTROL | WATTAGE | OUTPUT |
|-----------------------------|--|--|-------------|
| PS-Power Supply, 120-277VAC | UNI - 0-10V Dimming (0.1%), Phase Dimming (0.1%) | 30 - 30 Watts 60 - 60 Watts 96 - 96 Watts 3x96 - 3x96 Watts | 24 - 24 VDC |

Compatibility: View a complete list of compatible dimmers on the PS-UNI product page.

0-10V - 0.1% dimming
MLV/ELV/TRIAC - 0.1% dimming, consult dimming compatibility chart

| MODELS | PS-UNI-30W | PS-UNI-60W | PS-UNI-96W | PS-UNI-3X96W |
|--------|------------|------------|------------|--------------|
| Length | 6.50" | 7.40" | 8.66" | 11.85" |
| Width | 3.73" | 3.73" | 3.73" | 4.32" |
| Depth | 1.61" | 1.61" | 1.61" | 1.81" |

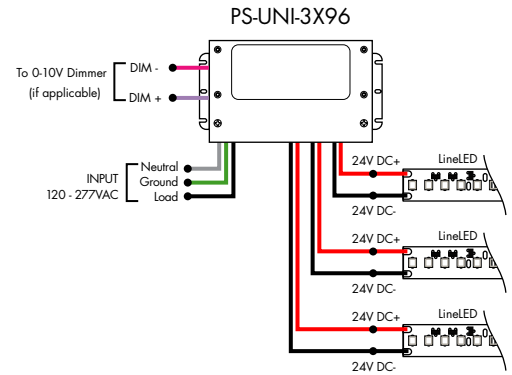
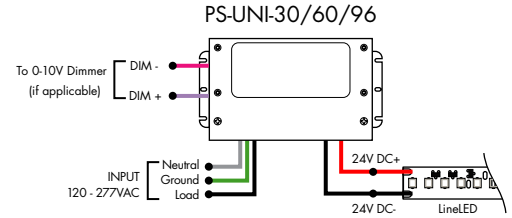

Ordering Code - DALI 2 Dimming Power Supplies 0.1% 120VAC - 277VAC

| MODEL | INPUT CONTROL | ENVIRONMENT | WATTAGE | OUTPUT |
|-----------------------------|------------------------------|-------------|---------------|-------------|
| PS-Power Supply, 120-277VAC | DALI2-DT6 - DALI2 DT6 (0.1%) | D - Dry | 96 - 96 Watts | 24 - 24 VDC |

| | |
|---------------|------------|
| Model | 96W |
| Length | 14.40" |
| Width | 5.20" |
| Depth | 2.60" |

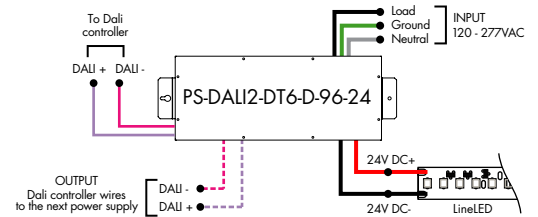

Power Supplies

See fixture and power supply instructions & spec sheet for wiring information. Dimming possible in select models - view Luminii website for list of compatible dimmers.

For use with Warm Dim

Ordering Code - 0-10V Dimming Power Supplies 0.1% 120VAC - 277VAC

| MODEL | INPUT CONTROL | ENVIRONMENT | WATTAGE | OUTPUT |
|-------------------------------|---|-------------|--------------------------------|-------------|
| PS - Power Supply, 120-277VAC | 010V-LIN - 0-10V Dimming (0.1%), Linear 010V-LOG - 0-10V Dimming (0.1%), Logarithmic | D - Dry | 96-96 Watts 3x96-3x96 Watts | 24 - 24 VDC |

| MODELS | 96W | 3X96 |
|--------|--------|--------|
| Length | 14.40" | 15.00" |
| Width | 5.20" | 6.62" |
| Depth | 2.60" | 4.45" |

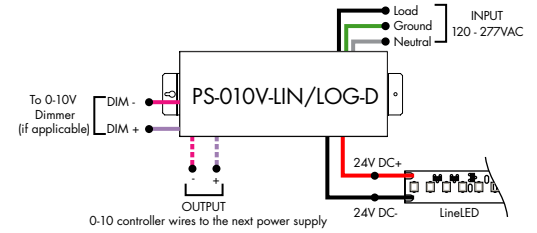

PS-010V-LIN/LOG-D-3X96

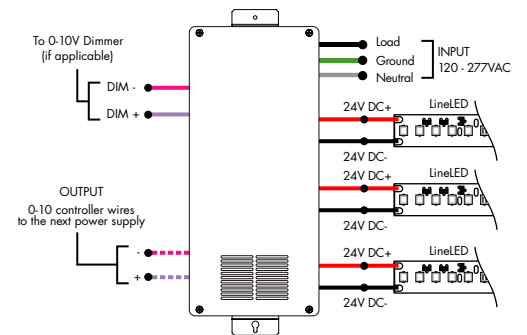

Ordering Code - Athena 0-10V LED Driver

| MODEL | INPUT CONTROL | ENVIRONMENT | WATTAGE | OUTPUT | FEATURE |
|-------------------------------|---|-------------|-------------|-------------|----------------|
| PS - Power Supply, 120-277VAC | 010V-LIN - 0-10V Dimming (0.1%), Linear 010V-LOG - 0-10V Dimming (0.1%), Logarithmic | D - Dry | 96-96 Watts | 24 - 24 VDC | AWNDR - Athena |

| MODELS | 96W |
|--------|--------|
| Length | 14.40" |
| Width | 5.20" |
| Depth | 2.60" |

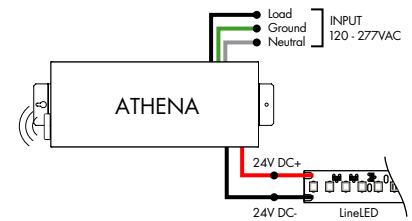

Power Supplies

See fixture and power supply instructions & spec sheet for wiring information. Dimming possible in select models - view Luminii website for list of compatible dimmers.

For use with Tunable White

Ordering Code - DALI2 Dimming Power Supplies 0.1% 120VAC - 277VAC

| MODEL | INPUT CONTROL | ENVIRONMENT | WATTAGE | OUTPUT |
|-------------------------------|---|-------------|---------------|-------------|
| PS - Power Supply, 120-277VAC | DALI2-DT8 - DALI DT8 Tunable White (0.1%) | D - Dry | 96 - 96 Watts | 24 - 24 VDC |

| MODELS | 96W |
|--------|--------|
| Length | 14.40" |
| Width | 5.20" |
| Depth | 2.60" |

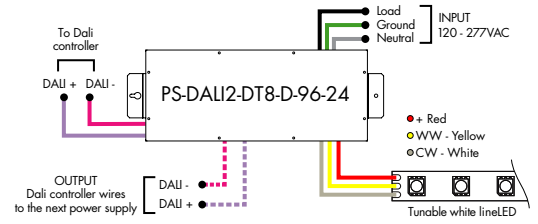

Ordering Code - Athena DALI2 Dimming Power Supplies 0.1% 120VAC - 277VAC

| MODEL | INPUT CONTROL | ENVIRONMENT | WATTAGE | OUTPUT | FEATURE |
|-------------------------------|---|-------------|---------------|-------------|----------------|
| PS - Power Supply, 120-277VAC | DALI2-DT8 - DALI DT8 Tunable White (0.1%) | D - Dry | 96 - 96 Watts | 24 - 24 VDC | AWN-R - Athena |

| MODELS | 96W |
|--------|--------|
| Length | 14.40" |
| Width | 5.20" |
| Depth | 2.60" |

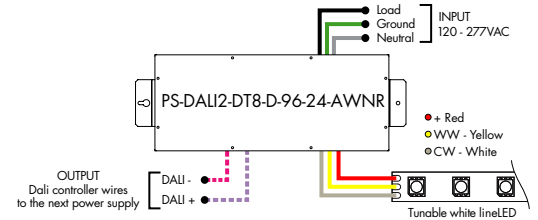

Ordering Code - DALI2 Dimming Power Supplies 0.1% 120VAC - 277VAC - for Dim-to-Warm functionality with Tunable White Output

| MODEL | INPUT CONTROL | ENVIRONMENT | WATTAGE | OUTPUT |
|-------------------------------|--------------------------------------|-------------|---------------|-------------|
| PS - Power Supply, 120-277VAC | DALI2-WD - DALI2 DT6 Warm Dim (0.1%) | D - Dry | 96 - 96 Watts | 24 - 24 VDC |

| MODELS | 96W |
|--------|--------|
| Length | 14.40" |
| Width | 5.20" |
| Depth | 2.60" |

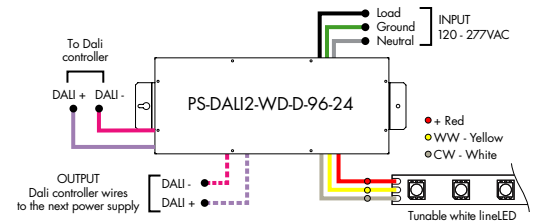

Ordering Code - DMX Dimming Power Supplies 0.1% 120VAC - 277VAC

| MODEL | INPUT CONTROL | ENVIRONMENT | WATTAGE | OUTPUT |
|-------------------------------|------------------|-------------|------------------------------------|-------------|
| PS - Power Supply, 120-277VAC | DMX - DMX (0.1%) | D - Dry | 96 - 96 Watts 3X96 - 3X96 Watts | 24 - 24 VDC |

| MODELS | 96W | 3X96 |
|--------|--------|--------|
| Length | 14.40" | 15.00" |
| Width | 5.20" | 6.62" |
| Depth | 2.60" | 4.56" |

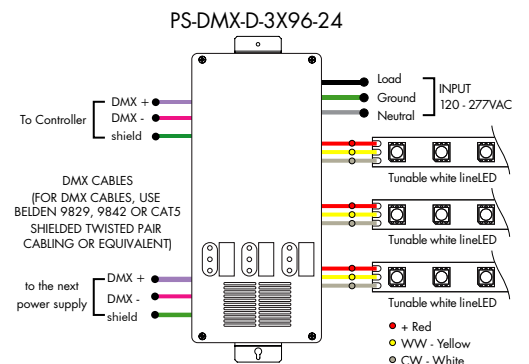
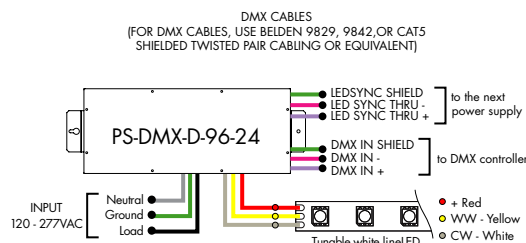

Power Supplies

See fixture and power supply instructions & spec sheet for wiring information. Dimming possible in select models - view Luminii website for list of compatible dimmers.

For use with Tunable White

Ordering Code - VintageDim® 0-10V Dimming Power Supplies 0.1% 120VAC - 277VAC

| MODEL | INPUT CONTROL | ENVIRONMENT | WATTAGE | OUTPUT |
|-------------------------------|---|-------------|---|-----------|
| PS - Power Supply, 120-277VAC | 010V-WD - 0-10V Dimming (0.1%), Standard Warm Dim Curve (with Tunable White LED) 010V-TW - 0-10V Dimming (0.1%), Two Channel Control, Brightness and CCT1-CCT2 Ratio 010V-2CH - 0-10V Dimming (0.1%), Two Channel Control, LED1 Brightness and LED2 Brightness 010V-WDX - 0-10V Dimming (0.1%), Customizable Warm Dim Curve (with Tunable White LED) 010V-2CHX - 0-10V Dimming (0.1%), Two Channel Control, Customizable Brightness and CCT1-CCT2 Ratio | D-Dry | 96-96 Watts 3X96-3x96 Watts ¹ | 24-24 VDC |

1 - 3x96 is only available with input control options 010V-WD and 010V-TW

| MODELS | 96W | 3X96 |
|---------------|--------|--------|
| Length | 14.40" | 15.00" |
| Width | 5.20" | 6.62" |
| Depth | 2.60" | 4.56" |

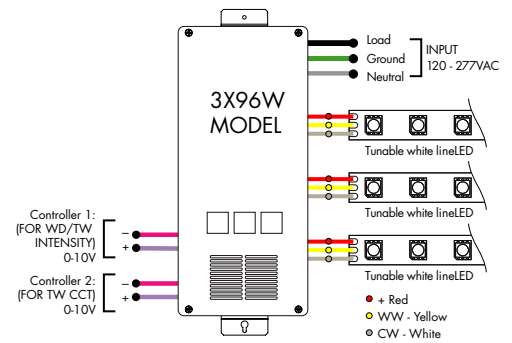
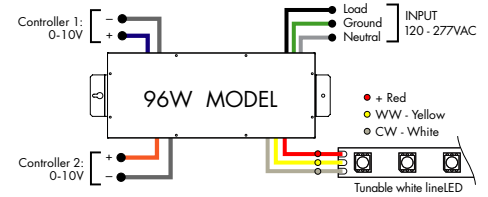

Ordering Code - Athena VintageDim® 0-10V Power Supply 0.1% 120VAC - 277VAC - for Dim-to-Warm functionality with Tunable White Output

| MODEL | INPUT CONTROL | ENVIRONMENT | WATTAGE | OUTPUT | FEATURE |
|-------------------------------|---|-------------|---------|-----------|--------------|
| PS - Power Supply, 120-277VAC | 010V-WD - 0-10V Dimming, Standard Warm Dim Curve (with Tunable White LED) | D-Dry | 96-96 W | 24-24 VDC | AWN - Athena |

| MODELS | 96W |
|---------------|--------|
| Length | 14.40" |
| Width | 5.20" |
| Depth | 2.60" |

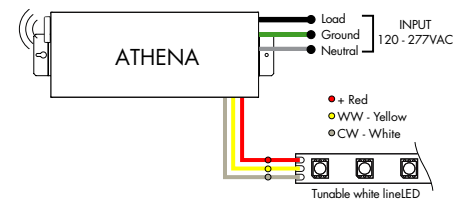

Ordering Code - Athena VintageDim® 0-10V Two Channel LED Driver, 0.1% 120VAC - 277VAC

| MODEL | INPUT CONTROL | ENVIRONMENT | WATTAGE | OUTPUT | FEATURE |
|-------------------------------|---|-------------|---------|-----------|--------------|
| PS - Power Supply, 120-277VAC | 010V-2CH - 0-10V Dimming Two Channel Control, LED1 Brightness and LED2 Brightness | D-Dry | 96-96 W | 24-24 VDC | AWN - Athena |

| MODELS | 96W |
|---------------|--------|
| Length | 14.40" |
| Width | 5.20" |
| Depth | 2.60" |

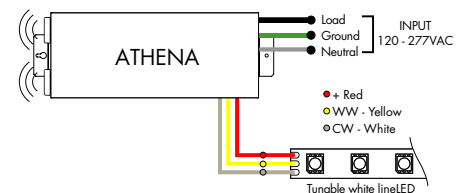

Power Supplies

See fixture and power supply instructions & spec sheet for wiring information. Dimming possible in select models - view Luminii website for list of compatible dimmers.

For use with RGB/RGBW

Ordering Code - Universal Dimming Power Supplies 0.1% 120VAC - 277VAC

| MODEL | INPUT CONTROL | WATTAGE | OUTPUT |
|-------------------------------|--|--|-------------|
| PS - Power Supply, 120-277VAC | UNI - 0-10V Dimming (0.1%), Phase Dimming (0.1%) | 30 - 30 Watts 60 - 60 Watts 96 - 96 Watts 3x96 - 3x96 Watts | 24 - 24 VDC |

| MODELS | PS-UNI-30W | PS-UNI-60W | PS-UNI-96W | PS-UNI-3X96W |
|---------------|------------|------------|------------|--------------|
| Length | 6.50" | 7.40" | 8.66" | 11.85" |
| Width | 3.73" | 3.73" | 3.73" | 4.32" |
| Depth | 1.61" | 1.61" | 1.61" | 1.81" |

REQUIRES A CONTROLLER AND A DECODER TO WORK PROPERLY

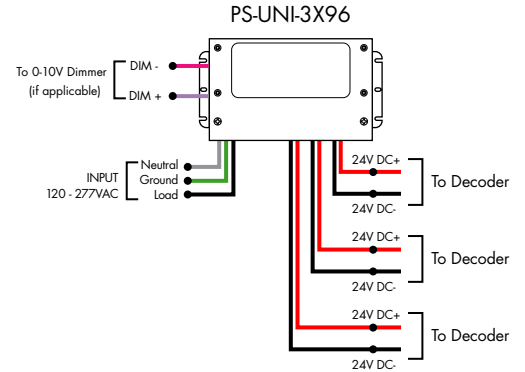
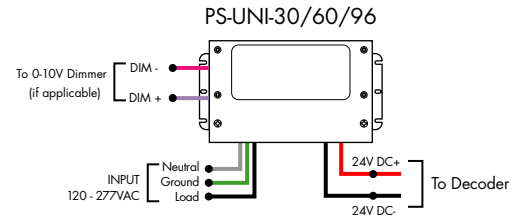

For use with RGB/RGBW

Ordering Code - DMX Dimming Power Supplies 0.1% 120VAC - 277VAC

| MODEL | INPUT CONTROL | ENVIRONMENT | WATTAGE | OUTPUT |
|-------------------------------|------------------|-------------|------------------------------------|-------------|
| PS - Power Supply, 120-277VAC | DMX - DMX (0.1%) | D - Dry | 96 - 96 Watts 3X96 - 3X96 Watts | 24 - 24 VDC |

| MODELS | 96W | 3X96 |
|---------------|--------|--------|
| Length | 14.40" | 15.00" |
| Width | 5.20" | 6.62" |
| Depth | 2.60" | 4.56" |

DMX CABLES (FOR DMX CABLES, USE BELDEN 9829, 9842 OR CAT5 SHIELDED TWISTED PAIR CABLING OR EQUIVALENT)

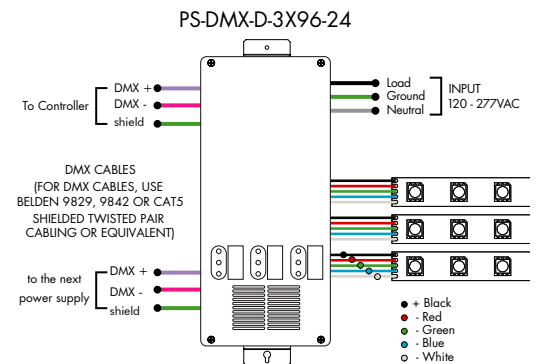
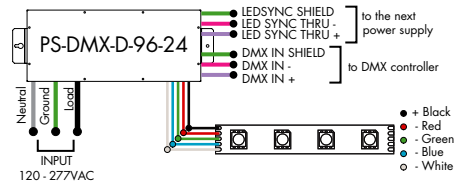

For use with RGB/RGBW/Pixel

Ordering Code - Non-Dimming Power Supply 120VAC - 277VAC

| MODEL | INPUT CONTROL | ENVIRONMENT | WATTAGE | OUTPUT |
|-----------------|------------------|-------------|---------------|-------------|
| PS - PSV Series | ND - Non Dimming | D - Dry | 96 - 96 Watts | 24 - 24 VDC |

| MODELS | 96W |
|---------------|--------|
| Length | 14.40" |
| Width | 5.20" |
| Depth | 2.60" |

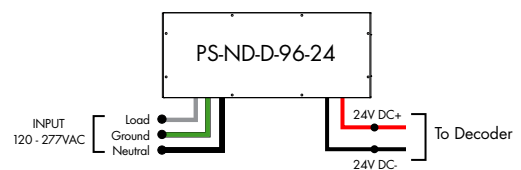

REQUIRES A CONTROLLER AND A DECODER TO WORK PROPERLY

Controllers and Decoders

For use with Tunable White Power Supplies



ORDERING CODE

MODEL

DTW-MC

DTW-MC - Tunable White controller

Tunable White wall-mount controller controls lighting fixtures, wireless control of TW lighting fixture. Fits in any standard US switch box. Includes all the outputs in the back of the controller.

Features

- Switch & dimming control function, control range > 20M.
- Smooth transition between light levels.
- Separately operate dimming and color temperature functions.
- Able to control 1 zone with endless receivers. Each receiver can maximally be controlled by 8 remotes.
- Power, temperature color and dimming functions operated by push button after receivers are connected.

Operating Voltage

3V DC battery

Color Parameters

- Brightness
- Saturation
- Fading



ORDERING CODE

MODEL

TW-DMX

TW-DMX - DMX controller

Tunable White DMX wall-mount controller is a fully touch sensitive controller designed in accordance with standard dimming protocol DMX512. Offers fast and accurate color temperature adjustment and brightness dimming of natural white, warm white and cold white. Designed with a touch color wheel, the DMX512 controller can adjust color temperature and brightness for all white LEDs smoothly and accurately. The DMX controller can control 1 zone with endless decoders.

Features

- 1 zone
- 6 color scenes
- DMX Control
- Touch Sensitive Glass Surface
- Dimming and Speed Control
- Memory Function
- Easily Fits Standard US Switch Boxes

Operating Voltage

12 - 24V DC

Color Parameters

- Brightness
- Saturation
- Primary colors
- Fading
- Color changing speed



ORDERING CODE

MODEL

SLD-DIMTW

SLD-DIMTW - Tunable white LED dimming module

The SLD DimTW is a constant voltage warm dimming LED dimming module. The unique dimming module accepts 0-10V control and mimics a smooth, incandescent dimming curve.

Features

- Flicker free 0-100% dimming
- High efficiency up to 97%
- High precision dimming ratio:>1:1000
- Fully isolated plastic housing
- Comply with EN55015 and FCC part 15 without additional input filter and capacitors
- compact size, high reliability
- 3 years warranty

Operating Voltage

8-48 VDC

Controllers and Decoders

For use with Tunable White, RGB/RGBW Power Supplies

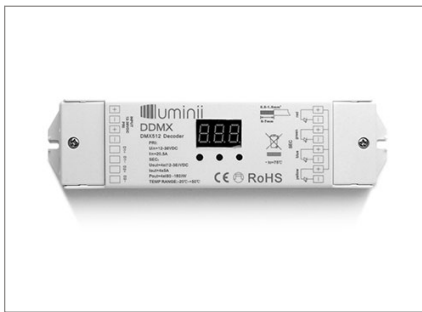

ORDERING CODE

MODEL

DDMX-RGBW

DDMX-RGBW - DMX decoder

Translates controller DMX512 programs for RGB and white LED strips.

Unique DMX address for the decoder can be set easily and displayed by the numeric display on the case. Changing and resetting the DMX address requires manual input.

Use power repeater to expand output.

Operating Voltage

12-36 VDC

Power Capacity

up to 96W at 24V

Operating Temperature Range

from -4°F to +122°F in case



ORDERING CODE

MODEL

RGBW-RC-R

RGBW-RC-R - RGBW receiver

The RGBW receiver is easily paired with controller by the click of a button. Receiver can be reset to factory settings at any time.

Each receiver can store one static RGB color, one color sequence, and one brightness setting for the white LED strip. Receivers assigned to the same scene within the same zone will have the same LED static color and color sequence.

Operating Voltage

12-36 VDC

Power Capacity

up to 96W at 24V

Operating Temperature Range

from -4°F to +122°F in case



ORDERING CODE

MODEL

RGBW-SR

RGBW-SR - RGBW signal repeater

Extends identical signal when connected in series to an RGBW LED control system. The RGBW signal repeater works with Luminii RGB and RGBW controllers, receivers, and decoders.

RGBW signal can be extended indefinitely when adequate power supply (not included) is connected to the system.

Operating Voltage

12-36 VDC

Power Capacity

up to 96W at 24V

Operating Temperature Range

from -4°F to +122°F in case

Controllers and Decoders

For use with RGB/RGBW Power Supplies



ORDERING CODE

MODEL

RGBW-MC3

RGBW-MC3 - 4-zone RGBW controller

Easy to operate wireless interface suitable for static or color changing scenes. Control 4 different color zones separately or at the same time. RGBW receiver (RGBW-RC-R) required for operation. Assign multiple receivers per zone to cover a large area.

Color wheel enables highly stable and sensitive color control functionality. Create your own color changing sequences with ease and flexibility.

Power

qty 3 AAA batteries

Scenes

up to 4 unique zones

Signal

Wireless (RF)

Energy Saving

Deactivates after 10 seconds of inactivity

Color Parameters

- Brightness
- Saturation
- Primary colors
- Speed of color changing sequence
- Fading

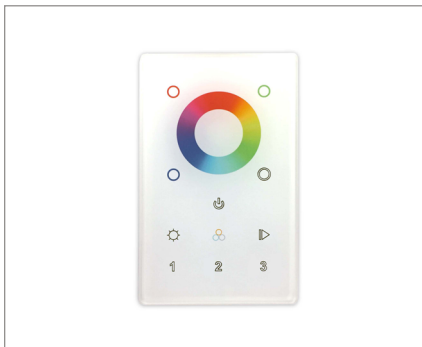

ORDERING CODE

MODEL

ZONES

COLOR



DMX-DMX Controller 3Z-Three Zone 1Z-One Zone RGBW-Red,Green, Blue,& White

DMX /Wireless RGB-W wall-mount controller controls DMX lighting fixtures, wireless control of RGB-W lighting fixture or use both simultaneously. Fits in any standard US switch box. Includes all the outputs in the back of the controller.

Control brightness levels with a single touch, personalize and memorize 3 different scenes, and even create 3 variations of white.

Features

- 2 in 1 in-Wall Controller: DMX Control or Wireless RGB-W
- 65,000 Color Options, Dimming and Speed Control
- Memory Function
- 50 Foot Wireless Range
- Easily Fits Standard US Switch Boxes
- Touch Sensitive Glass Surface
- Includes 10 Built in Programs, or Create and Play Your Own

Operating Voltage

12 - 24V DC

Color Parameters

- Brightness
- Saturation
- Primary colors
- Fading
- Color changing speed

For use with Tunable White, RGB/RGBW, Pixel Power Supplies

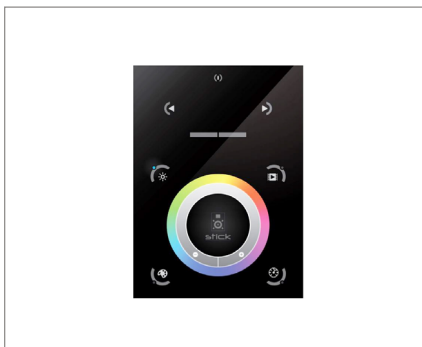

ORDERING CODE

MODEL

TSDMX-E

TSDMX-E - Touchscreen DMX controller

Programmable advanced DMX512 lighting controller featuring a touch-screen interface. Operates as stand alone controller or integrated with most architectural lighting control systems. Can controller endless DMX512 enabled devices.

Mounts to standard single or dual gang wall box with the included power supply inside the junction box. Terminal block design for power and data connections.

Features

- Sleek glass design which sits 0.43" from the wall
- Graphical color display to show selected environment
- Color/dimmer/speed palette
- Color temperature mixing
- Touch sensitive buttons. No mechanical parts
- Touch sensitive wheel allows for accurate color selection
- Multi-zone microSD memory
- Multi-room control with 500 scenes, 10 zones
- 1024 DMX channels. Control 340 RGB fixtures
- USB & Ethernet connectivity for programming and control

Power Supply

7 VDC (included)

Programmability

PC, Mac, Tablet, Smartphone

Output Signal

DMX512 (1024 channels)

Color Parameters

- Brightness
- Saturation
- Speed of color changing sequence
- Fading / dimming / brightness

Controllers and Decoders

For use with Tunable White, RGB/RGBW Power Supplies

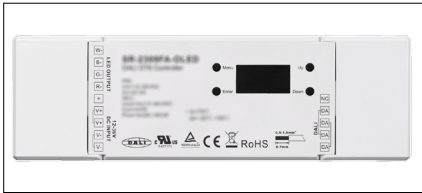

ORDERING CODE

MODEL

DALI2-DT8-RGBW

DALI2-DT8-RGBW - DALI-2 RGBW Decoder

A 4-channel DALI2 DT8 decoder designed to control RGB, RGBW, and TW LED fixtures, featuring adjustable color temperature and customizable lumen output.

Voltage/Frequency
12-36VDC

Max Output Power
4 output channels, 60-180W each

Max Output Current
4 output channels, max of 5A each

Ambient Operating Temperature Range
-20 to 50°C

Environment
Dry (IP20)



ORDERING CODE

MODEL

DDMX-5CH-RDM-PRO

DDMX-5CH-RDM-PRO - DMX512 Decoder

DMX512 decoder with RDM functionality features 5 PWM output channels with common anode. High PWM output frequency range allows the product to be used in HD video conferencing spaces. All DMX products to be installed per DMX512 Standard.

Power

96 Watt

Inputs

RJ45, XLR-5Pin, Terminal Block

DMX Channels

1 to 5 settable

PWM Output Resolution Ratio

8 or 16 bit

PWM Output Frequency

500Hz - 30KHz

Output Dimming Curve Gamma Value

0.1 ~ 9.9



ORDERING CODE

MODEL

RGBW-WI-R

RGBW-WI-R - WIFI generator

RGBW-WI-R creates a local network that enables any electronic device (phone, tablet, etc.) to control the RGB/W strip connected to a RGBW-RC-R receiver.

The control functions are achieved through a free application download for Android and iOS devices called REALCOLOR.

Operating Voltage

12-36 VDC

Power Supply

PI-130-24 (included)

Operating Temperature Range

from -4°F to +122°F in case

For use with Pixel Power Supplies

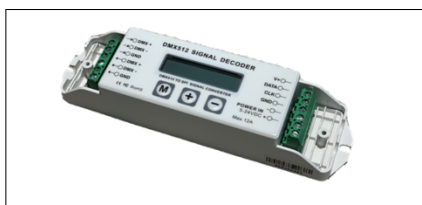

ORDERING CODE

MODEL

SR-DMX-SPI

SR-DMX-SPI - Smart Pixel Decoder

The SR-DMX-SPI is a smart LED pixel decoder that controls RGB/RGBW pixel LED strips with SPI signal. Designed with an OLED backlit panel, the pixel controller allows for easy configuration of most settings. Four push buttons are available for control of the LED functions.

*For pixel only.

Features

- 2 in 1 in-Wall Controller: DMX Control or Wireless RGB-W
- SPI signal output for RGB/RGBW pixel light control
- DMX512 controllable and RF/WIFI remote controllable
- Capable of addressing up to 1020 RGB pixels & 765 RGBW pixels
- OLED panel allows for easy configuration

Operating Voltage

12 - 36V DC

Power capacity

up to 96W at 24V

Operating temperature range

from -4°F to +122°F in case