

Features

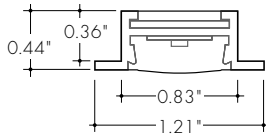

- 24VDC Class 2 and IP68 rated for wet locations, fixtures made to order up to 144". Fixtures can be linked up to 30' depending on output
- Suitable for millwork, recessed, wet, outdoor, architectural reveals, and accent lighting applications
- Dot free even illumination with frosted lens
- Proprietary strong bond solder method handles up to 50 lbs of pull force on wire leads and connectors.
- Average Life (L70): 50,000hrs
- 3 year warranty
- Tunable White allows individual control of CCT and output, can be paired with Vintage Dim power supply for warm dim effect
- Warm Dim follows the incandescent dimming curve and is compatible with MLV, ELV, and Incandescent dimmers.
- RGB offers balanced output across the color gamut and a true white with RGBW
- Smart Pixel allows for infinite color combinations with cascading and chasing effects

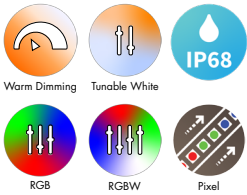

Finish Options (see page 3 for additional information)

- Base Silver Anodized
- Powder Coat Black Bronze White
- Premium Matte Black Warm Nickel Aged Brass Polished Gold Chrome



Technical Information

TYPE	Warm Dim	Tunable White	RGBW		RGB		Pixel	
OUTPUT OPTIONS	WD60X2VHO (22K-32K)	TW60X2HO (22K-46K)	RGBW36SO	RGBW36HO	RGB42SO	RGB42HO	RGBWX18SO	RGBX18SO
Lumens Output (all channels full on) (with a Clear Lens)	440 lm/ft	355 lm/ft	142 lm/ft	235 lm/ft	141 lm/ft	207 lm/ft	171 lm/ft	113 lm/ft
Average Power Consumption (for a 4' section)	10.1 W/ft	7.3 W/ft	4 W/ft	7.6 W/ft	4.5 W/ft	8.3 W/ft	5.7 W/ft	4.5 W/ft
Efficacy	44 lm/W	49 lm/W	36 lm/W	31 lm/W	31 lm/W	25 lm/W	30 lm/W	25 lm/W
Max Run Length (in series)	12 ft	26 ft	26 ft	13 ft	28 ft	13 ft	20 ft	30 ft
Ambient Operating Temperature Range*	-15°F - 90°F (-25°C - 30°C)	-15°F - 105°F (-25°C - 40°C)	-15°F - 115°F (-25°C - 45°C)	-15°F - 95°F (-25°C - 35°C)	-15°F - 115°F (-25°C - 45°C)	-15°F - 90°F (-25°C - 30°C)	-15°F - 125°F (-25°C - 50°C)	
Control/Dimming Protocol	MLV, ELV, Inc.	0-10V, DMX	DMX				SPI Protocol UCS 2904	SPI Protocol UCS 2903

* Ambient Operating Temperature Range to maintain L70 of 50k+ hours in normal mounting conditions for the fixture. Exceeding Ambient Operating Temperature Range may result in decreased life/output. Consult Technical Support for specific inquiries.

Warm Dim (WD60X2)					Tunable White (TW60X2)					RGBW (4000K)					Dominant Wavelength		
CCT	CRI	TM-30			CCT	CRI	TM-30			Tape	CRI	TM-30		Color	RGB42/RGBW36	RGBX18/RGBWX18	
		R _f	R _g	R ₉			R _f	R _g	R ₉			R _f	R _g				R ₉
2200K	96	92	96	94	2200K	97	94	98	95	RGBW36	95	93	106	84	Red	620nm	621nm
3200K	96	93	106	95	3500K	98	96	102	94	RGBWX18	93	91	99	64	Green	525nm	519nm
					4600K	97	94	105	97						Blue	467nm	465nm

Ordering Code

MODEL	LENGTH ¹	OUTPUT ²	CCT	LENS	MOUNTING	FINISH ³	FEED POSITION LEFT ⁵	FEED POSITION RIGHT ⁵
KRLW - Kendo L Wet Recessed	12"-144" 2" increments	WD60X2VHO - Very High	22K32K - 2200K - 3200K	C - Clear F - Frosted	HS - Hard Surface mounting bracket GS - Gypsum surface mounting bracket NB - No bracket	BASE SA - Silver Anodized	WIRE LEADS (72") LWB - Wire Back Feed LNPF - No Power Feed	WIRE LEADS (72") RWB - Wire Back Feed RNPF - No Power Feed
	12"-144" 2" increments	TW60X2HO - High	22K46K - 2200K - 4600K			STANDARD BK - Black BZ - Bronze WH - White		
	12"-144" 2" increments	RGBW36SO - Standard RGBW36HO - High RGB42SO - Standard RGB42HO - High	CLR - Color			PREMIUM MBK - Matte Black WN - Warm Nickel AB - Aged Brass PG - Polished Gold ⁴ CH - Chrome ⁴	QUICK CONNECTS (6") LFB - Female Q/C, Back Feed LNPF - No Power Feed	QUICK CONNECTS (6") RFB - Female Q/C, Back Feed RNPF - No Power Feed
	12"-144" 4" increments	RGBWX18SO - Standard RGBX18SO - Standard	PXSPI - Smart Pixel Control					

1 - Custom lengths and increments are available, please consult Inside Sales with specific request.
 2 - Tunable White options can be used to comply with Title 24 JAB at max brightness depending on lens selection, see multiplier charts to calculate specific efficacy.
 3 - Non Base finishes may have extended lead times. Custom RALs are available, please consult Inside Sales with specific request.
 4 - Polished Gold finishes and Chrome finishes have a maximum fixture length of 96".
 5 - LNPF - RNPF is not a valid configuration option

Powerfeeds and Connectors

Power Feed Position Options and Orientation

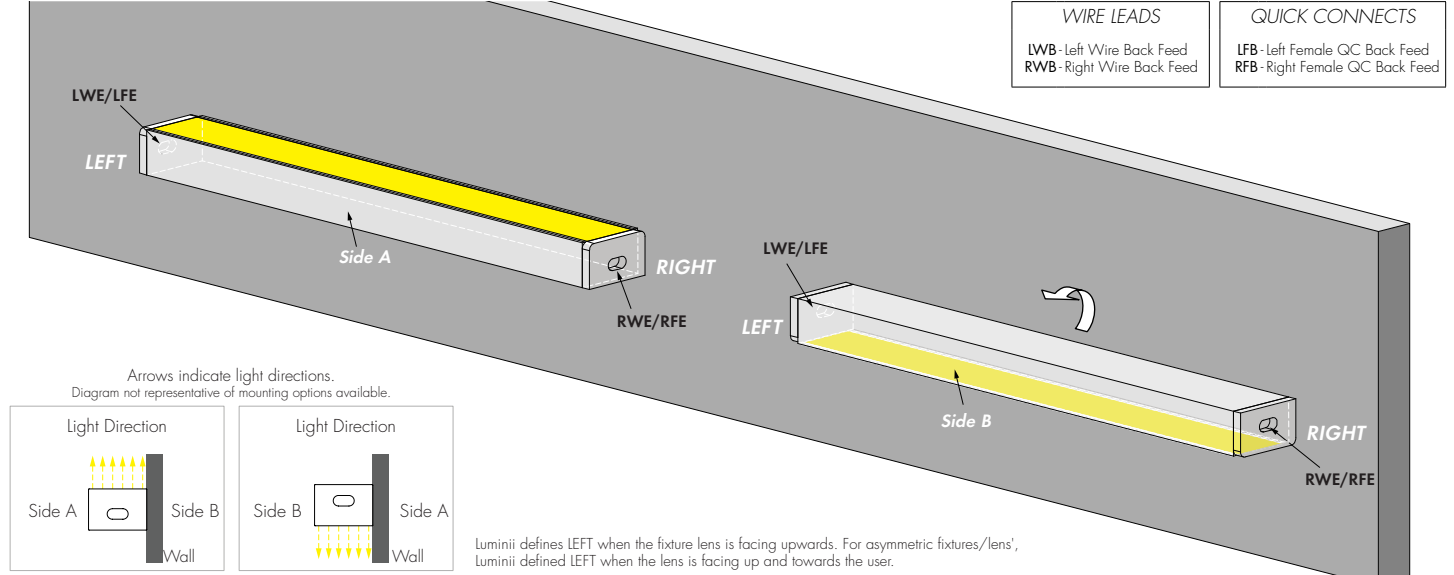

**Linking and Extension Cable Options
For use with Warm Dim (WD60X2):**

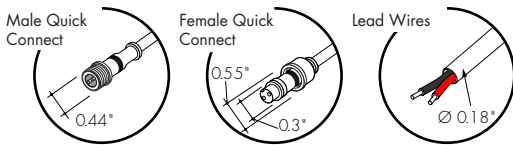

WET-MFA-2-2
Female to Male Adapter, 2 pin

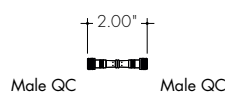

WET-CON-LEAD-M-2-48
Male Wet Connector Cable, 2 pin, 48"

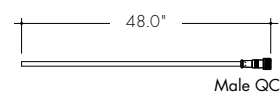

WET-CON-JC-F-M-2-48
Female/Male Wet Jumper Cable, 2 pin, 48"

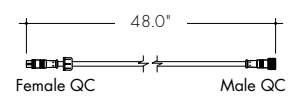

For use with Tunable White (TW60X2), RGB Pixel (RGBX18) and RGBW Pixel (RGBWX18):

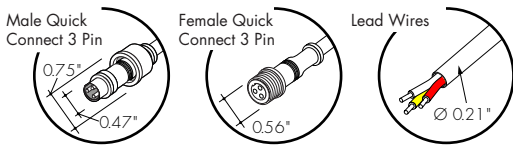

WET-MFA-3-2
Male to Female Adapter, 3 pin

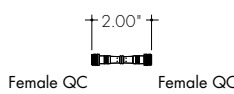

WET-CON-LEAD-F-3-48
Female Wet Connector Cable, 3 pin, 48"

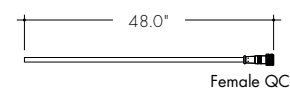

WET-CON-JC-M-F-3-48
Male/Female Wet Jumper Cable, 3 pin, 48"

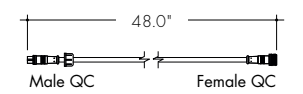

For use with RGB (RGB42):

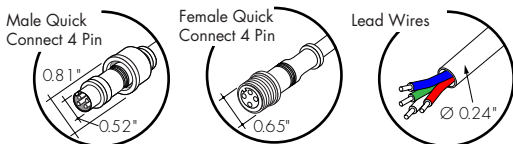

WET-MFA-4-2
Male to Female Adapter, 4 pin

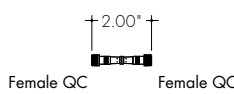

WET-CON-LEAD-F-4-48
Female Wet Connector Cable, 4 pin, 48"

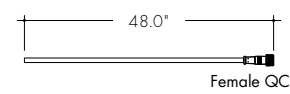

WET-CON-JC-M-F-4-48
Male/Female Wet Jumper Cable, 4 pin, 48"

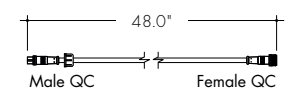

For use with RGBW (RGBW36):

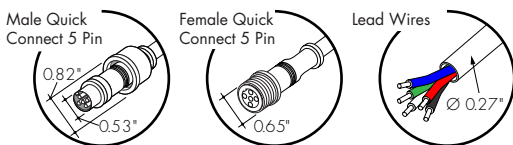

WET-MFA-5-2
Male to Female Adapter, 5 pin

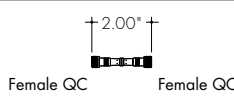

WET-CON-LEAD-F-5-48
Female Wet Connector Cable, 5 pin, 48"

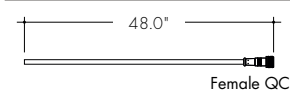

WET-CON-JC-M-F-5-48
Male/Female Wet Jumper Cable, 5 pin, 48"

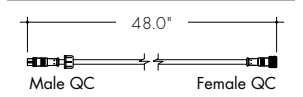

Sample Layout

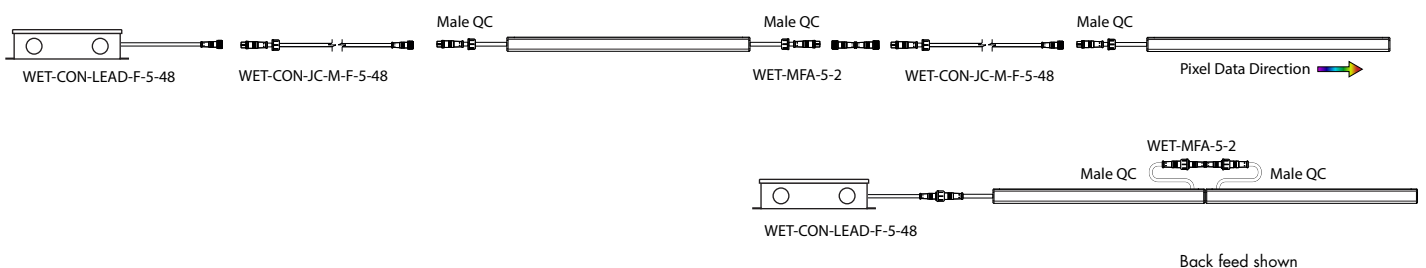

Product Dimensions

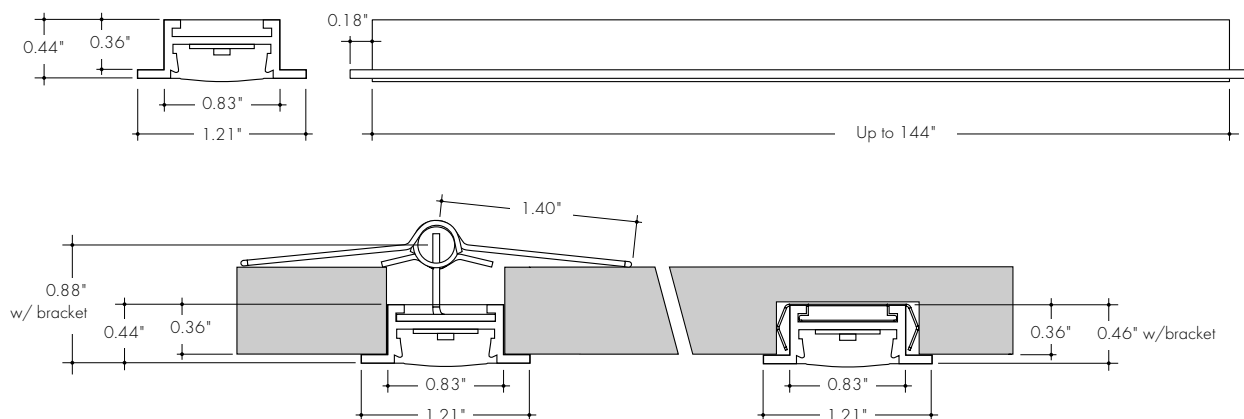

Note: Spring Bracket minimum ceiling thickness is 3/8", maximum ceiling thickness for drywall is 5/8".

Finish Options

- Finish options are available in a wide variety, allowing for complete customization of style and aesthetic.
- Non Base finishes may have extended lead times and price adder.
- Polished Gold and Chrome finishes have a maximum fixture length of 96".
- Custom RALs are available, please consult Inside Sales with specific request.

Silver Anodized Base

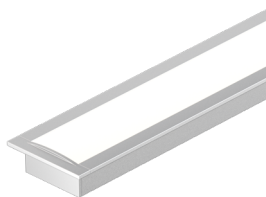

Silver Anodized is a soft silver with a clear finish.

Black Powder Coat



Black is a true deep black with a glossy finish.

Bronze Powder Coat



Bronze is a rich, dark brown with a satin finish.

White Powder Coat



White is a polar bright white and field paintable.

Matte Black Premium



Matte Black is a dark, pitch-black with a soft flat finish.

Warm Nickel Premium

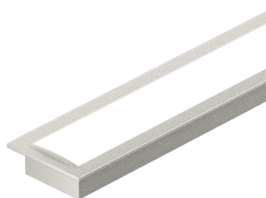

Warm Nickel is a soft, silvery smoke with warm tones and a satin finish.

Aged Brass Premium



Aged Brass is a deep brown shade with slightly golden undertones.

Polished Gold Premium

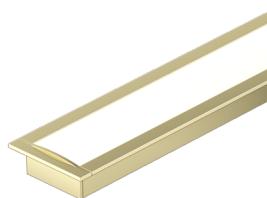

Polished Gold is bright and radiant for a brilliant finish.

Chrome Premium

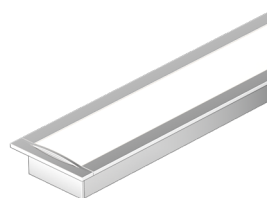

Chrome is a highly reflective silver polish.

Light Transmission and Dotting

Output Options	Lens/Accessory							
	Clear Lens				Frosted Lens			
Dimming Level	100%	50%	10%	1%	100%	50%	10%	1%
WD68SO	CD	CD	CD	CD	ND	ND	SD	SD
TW60X2HO (All On)	CD	CD	CD	CD	SD	CD	CD	CD
TW60X2HO (1-Channel)	CD	CD	CD	CD	CD	CD	CD	CD
RGBW36SO	CD	CD	CD	CD	CD	CD	CD	CD
RGBW36HO	CD	CD	CD	CD	CD	CD	CD	CD
RGB42SO	CD	CD	CD	CD	CD	CD	CD	CD
RGB42HO	CD	CD	CD	CD	CD	CD	CD	CD
RGBWX18SO	CD	CD	CD	CD	CD	CD	CD	CD
RGBX18SO	CD	CD	CD	CD	CD	CD	CD	CD
Transmission Percentage	100%				46%			

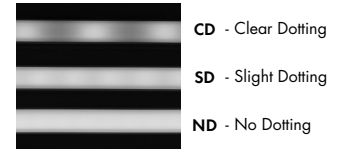

Accessory Options

LVSP-WET

Splice box: wet rated, low voltage, gray

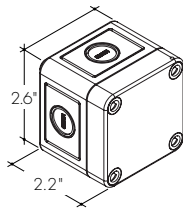

LVSP-WET-CM

Connector for splice box, low voltage for cable management, gray.

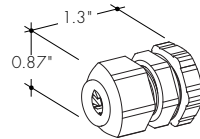

Power Consumption

Tested at Full Power with PS-UNI Series power supplies.

Standard Nominal Lengths offered provide minimal shadowing. For alternate lengths, please consult Inside Sales with specific request.

Warm Dim (WD60X2)

Nominal Length (in)	Actual Length	Watts VHO	Nominal Length (in)	Actual Length	Watts VHO	Nominal Length (in)	Actual Length	Watts VHO	Nominal Length (in)	Actual Length	Watts VHO
12	10 11/16	11.4	47	—	—	82	81	63.4	117	116 3/16	84.7
13	12 2/16	11.4	48	47 4/16	38.9	83	82 7/16	64.8	118	117 9/16	85.8
14	13 8/16	12.1	49	48 11/16	40.5	84	83 13/16	65.6	119	119	86.4
15	14 15/16	12.9	50	—	—	85	—	—	120	—	—
16	—	—	51	50 1/16	41.3	86	85 4/16	66.3	121	120 6/16	87.5
17	16 5/16	13.7	52	51 8/16	42.9	87	86 10/16	67.4	122	121 13/16	88.2
18	17 12/16	15.2	53	52 14/16	43.7	88	—	—	123	—	—
19	—	—	54	—	—	89	88 1/16	68.0	124	123 3/16	88.9
20	19 2/16	15.9	55	54 5/16	44.6	90	89 7/16	69.0	125	124 10/16	90.3
21	20 9/16	17.5	56	55 11/16	46.2	91	90 14/16	69.6	126	—	—
22	21 15/16	18.2	57	—	—	92	—	—	127	126	91.0
23	—	—	58	57 2/16	47.0	93	92 4/16	70.1	128	127 7/16	92.5
24	23 6/16	19.0	59	58 8/16	48.7	94	93 11/16	71.2	129	128 13/16	93.2
25	24 12/16	20.5	60	59 15/16	49.5	95	—	—	130	—	—
26	—	—	61	—	—	96	95 1/16	71.8	131	130 4/16	93.9
27	26 3/16	21.4	62	61 5/16	50.3	97	96 8/16	72.9	132	131 10/16	95.3
28	27 9/16	23.2	63	62 12/16	51.5	98	97 14/16	73.5	133	—	—
29	29	24.1	64	—	—	99	—	—	134	133 1/16	96.0
30	—	—	65	64 2/16	52.1	100	99 5/16	74.2	135	134 7/16	95.9
31	30 6/16	25.9	66	65 9/16	53.3	101	100 11/16	75.5	136	135 14/16	95.9
32	31 13/16	26.8	67	66 15/16	53.9	102	—	—	137	—	—
33	—	—	68	—	—	103	102 2/16	76.2	138	137 4/16	95.9
34	33 3/16	27.7	69	68 6/16	54.5	104	103 8/16	77.5	139	138 11/16	95.8
35	34 10/16	29.5	70	69 12/16	55.6	105	104 15/16	78.2	140	—	—
36	—	—	71	—	—	106	—	—	141	140 1/16	95.7
37	36	30.4	72	71 3/16	56.2	107	106 5/16	78.8	142	141 8/16	95.7
38	37 7/16	32.1	73	72 9/16	57.4	108	107 12/16	80.1	143	142 14/16	95.6
39	38 13/16	32.8	74	74	58.2	109	—	—	144	—	—
40	—	—	75	—	—	110	109 2/16	80.8			
41	40 4/16	33.6	76	75 6/16	59.7	111	110 9/16	81.9			
42	41 10/16	35.1	77	76 13/16	60.4	112	111 15/16	82.5			
43	—	—	78	—	—	113	—	—			
44	43 1/16	35.9	79	78 3/16	61.1	114	113 6/16	83.0			
45	44 7/16	37.4	80	79 10/16	62.6	115	114 12/16	84.2			
46	45 14/16	38.2	81	—	—	116	—	—			

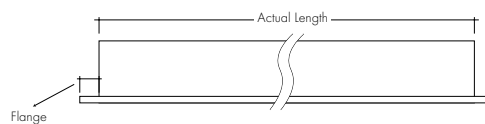

Power Consumption

Tested at Full Power with PS-UNI Series power supplies.

Standard Nominal Lengths offered provide minimal shadowing. For alternate lengths, please consult Inside Sales with specific request.

Tunable White (TW60X2)

Nominal Length (in)	Actual Length	Watts	Nominal Length (in)	Actual Length	Watts	Nominal Length (in)	Actual Length	Watts	Nominal Length (in)	Actual Length	Watts
		HO			HO			HO			HO
12	10 11/16	7.7	47	—	—	82	81	43.6	117	116 3/16	58.6
13	12 2/16	7.7	48	47 4/16	25.5	83	82 7/16	44.5	118	117 9/16	59.6
14	13 8/16	8.4	49	48 11/16	26.6	84	83 13/16	44.9	119	119	60.1
15	14 15/16	9.1	50	—	—	85	—	—	120	—	—
16	—	—	51	50 1/16	27.1	86	85 4/16	45.4	121	120 6/16	61.1
17	16 5/16	9.8	52	51 8/16	28.2	87	86 10/16	46.2	122	121 13/16	61.5
18	17 12/16	11.1	53	52 14/16	28.7	88	—	—	123	—	—
19	—	—	54	—	—	89	88 1/16	46.6	124	123 3/16	61.8
20	19 2/16	11.8	55	54 5/16	29.2	90	89 7/16	47.3	125	124 10/16	62.4
21	20 9/16	13.1	56	55 11/16	30.3	91	90 14/16	47.7	126	—	—
22	21 15/16	13.8	57	—	—	92	—	—	127	126	62.8
23	—	—	58	57 2/16	30.8	93	92 4/16	48.1	128	127 7/16	63.4
24	23 6/16	14.5	59	58 8/16	31.8	94	93 11/16	48.9	129	128 13/16	63.8
25	24 12/16	15.8	60	59 15/16	32.4	95	—	—	130	—	—
26	—	—	61	—	—	96	95 1/16	49.2	131	130 4/16	64.1
27	26 3/16	16.2	62	61 5/16	32.9	97	96 8/16	50.0	132	131 10/16	64.8
28	27 9/16	16.9	63	62 12/16	34.0	98	97 14/16	50.4	133	—	—
29	29	17.2	64	—	—	99	—	—	134	133 1/16	65.1
30	—	—	65	64 2/16	34.6	100	99 5/16	50.9	135	134 7/16	65.5
31	30 6/16	17.9	66	65 9/16	35.8	101	100 11/16	51.7	136	135 14/16	65.7
32	31 13/16	18.3	67	66 15/16	36.4	102	—	—	137	—	—
33	—	—	68	—	—	103	102 2/16	52.2	138	137 4/16	65.8
34	33 3/16	18.6	69	68 6/16	37.0	104	103 8/16	53.0	139	138 11/16	66.2
35	34 10/16	19.3	70	69 12/16	38.1	105	104 15/16	53.5	140	—	—
36	—	—	71	—	—	106	—	—	141	140 1/16	66.4
37	36	19.7	72	71 3/16	38.7	107	106 5/16	53.9	142	141 8/16	66.8
38	37 7/16	20.6	73	72 9/16	39.9	108	107 12/16	54.7	143	142 14/16	66.9
39	38 13/16	21.1	74	74	40.3	109	—	—	144	—	—
40	—	—	75	—	—	110	109 2/16	55.2			
41	40 4/16	21.7	76	75 6/16	41.3	111	110 9/16	56.2			
42	41 10/16	22.8	77	76 13/16	41.7	112	111 15/16	56.7			
43	—	—	78	—	—	113	—	—			
44	43 1/16	23.3	79	78 3/16	42.2	114	113 6/16	57.2			
45	44 7/16	24.4	80	79 10/16	43.1	115	114 12/16	58.1			
46	45 14/16	25.0	81	—	—	116	—	—			

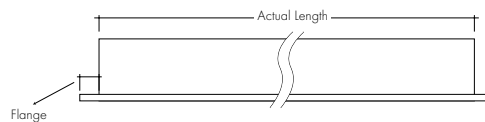

Power Consumption

Tested at Full Power with PS-UNI Series power supplies.

Standard Nominal Lengths offered provide minimal shadowing. For alternate lengths, please consult Inside Sales with specific request.

RGB/RGBW (RGB42/RGBW36)

Nominal Length (in)	Actual Length	Watts				Nominal Length (in)	Actual Length	Watts				Nominal Length (in)	Actual Length	Watts				Nominal Length (in)	Actual Length	Watts			
		RGBW36		RGB42				RGBW36		RGB42				RGBW36		RGB42				RGBW36		RGB42	
		SO	HO	SO	HO			SO	HO	SO	HO			SO	HO	SO	HO			SO	HO	SO	HO
12	10 11/16	4.0	7.3	4.4	8.6	47	46 2/16	14.4	27.5	16.8	31.3	82	81 9/16	26.1	49.6	29.4	53.8	117	-	-	-	-	
13	12 11/16	4.0	7.3	4.4	8.6	48	-	-	-	-	-	83	-	-	-	-	-	118	117	37.1	66.2	41.3	73.1
14	-	-	-	-	-	49	48 2/16	15.1	28.8	17.5	32.7	84	83 9/16	26.8	50.8	30.0	55.0	119	119	37.8	67.5	41.9	74.0
15	14 10/16	4.5	8.5	5.2	10.0	50	-	-	-	-	-	85	-	-	-	-	-	120	-	-	-	-	-
16	-	-	-	-	-	51	50 1/16	15.8	30.0	18.3	34.0	86	85 8/16	27.4	51.9	30.7	56.2	121	120 15/16	38.6	68.7	42.6	74.9
17	16 10/16	5.1	9.7	5.9	11.3	52	-	-	-	-	-	87	-	-	-	-	-	122	-	-	-	-	-
18	-	-	-	-	-	53	52 1/16	16.4	31.2	18.9	35.1	88	87 8/16	28.0	52.9	31.4	57.3	123	122 15/16	39.2	69.7	43.2	75.3
19	18 9/16	5.6	10.9	6.7	12.6	54	-	-	-	-	-	89	-	-	-	-	-	124	-	-	-	-	-
20	-	-	-	-	-	55	54	17.0	32.4	19.6	36.3	90	89 7/16	28.6	53.8	32.2	58.4	125	124 14/16	39.7	70.7	43.8	75.7
21	20 9/16	6.2	12.1	7.4	13.9	56	56	17.6	33.5	20.3	37.5	91	-	-	-	-	-	126	-	-	-	-	-
22	-	-	-	-	-	57	-	-	-	-	-	92	91 7/16	29.2	54.8	32.9	59.5	127	126 14/16	40.3	71.7	44.4	76.1
23	22 8/16	6.7	13.3	8.2	15.2	58	57 15/16	18.2	34.7	21.0	38.7	93	-	-	-	-	-	128	-	-	-	-	-
24	-	-	-	-	-	59	-	-	-	-	-	94	93 6/16	29.9	55.8	33.6	60.5	129	128 13/16	40.8	72.8	45.0	76.6
25	24 8/16	7.3	14.5	8.9	16.6	60	59 15/16	18.9	35.9	21.7	39.8	95	-	-	-	-	-	130	-	-	-	-	-
26	-	-	-	-	-	61	-	-	-	-	-	96	95 6/16	30.2	56.3	34.0	61.1	131	130 13/16	41.4	73.8	45.6	77.0
27	26 7/16	8.0	15.7	9.6	18.0	62	61 14/16	19.5	37.1	22.4	41.1	97	-	-	-	-	-	132	-	-	-	-	-
28	-	-	-	-	-	63	-	-	-	-	-	98	97 5/16	30.8	57.2	34.7	62.2	133	132 12/16	41.9	74.8	46.3	77.4
29	28 7/16	8.6	17.0	10.4	19.4	64	63 14/16	20.2	38.4	23.2	42.4	99	-	-	-	-	-	134	-	-	-	-	-
30	-	-	-	-	-	65	-	-	-	-	-	100	99 5/16	31.3	57.9	35.4	63.4	135	134 12/16	42.5	75.5	46.8	78.1
31	30 6/16	9.3	18.2	11.1	20.7	66	65 13/16	20.8	39.7	24.0	43.7	101	-	-	-	-	-	136	-	-	-	-	-
32	-	-	-	-	-	67	-	-	-	-	-	102	101 4/16	31.9	58.6	36.0	64.7	137	136 11/16	43.1	76.3	47.3	78.8
33	32 6/16	9.7	18.8	11.5	21.4	68	67 13/16	21.5	41.0	24.7	45.1	103	-	-	-	-	-	138	-	-	-	-	-
34	-	-	-	-	-	69	-	-	-	-	-	104	103 4/16	32.4	59.3	36.7	65.9	139	138 11/16	43.7	77.0	47.8	79.6
35	34 5/16	10.3	20.0	12.2	22.8	70	69 12/16	22.1	42.3	25.5	46.4	105	-	-	-	-	-	140	-	-	-	-	-
36	-	-	-	-	-	71	-	-	-	-	-	106	105 3/16	32.9	60.0	37.3	67.2	141	140 10/16	44.3	77.7	48.3	80.3
37	36 5/16	11.0	21.3	13.0	24.2	72	71 12/16	22.8	43.5	26.3	47.8	107	-	-	-	-	-	142	-	-	-	-	-
38	-	-	-	-	-	73	-	-	-	-	-	108	107 3/16	33.5	60.7	38.0	68.4	143	142 10/16	44.9	78.5	48.8	81.0
39	38 4/16	11.7	22.5	13.7	25.6	74	73 11/16	23.5	44.8	26.9	49.0	109	-	-	-	-	-	144	-	-	-	-	-
40	-	-	-	-	-	75	-	-	-	-	-	110	109 2/16	34.0	61.4	38.6	69.7						
41	40 4/16	12.4	23.8	14.5	27.0	76	75 11/16	24.1	46.0	27.6	50.2	111	-	-	-	-	-						
42	-	-	-	-	-	77	-	-	-	-	-	112	111 2/16	34.8	62.6	39.3	70.5						
43	42 3/16	13.1	25.0	15.2	28.5	78	77 10/16	24.8	47.2	28.2	51.4	113	-	-	-	-	-						
44	-	-	-	-	-	79	-	-	-	-	-	114	113 1/16	35.6	63.8	39.9	71.4						
45	44 3/16	13.8	26.3	16.0	29.9	80	79 10/16	25.4	48.4	28.8	52.6	115	-	-	-	-	-						
46	-	-	-	-	-	81	-	-	-	-	-	116	115 1/16	36.3	65.0	40.6	72.3						

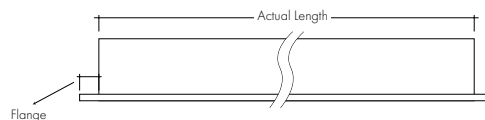

Power Consumption

Tested at Full Power with PS-UNI Series power supplies.

Standard Nominal Lengths offered provide minimal shadowing. For alternate lengths, please consult Inside Sales with specific request.

PIXEL (RGBX18/RGBWX18)

Nominal Length (in)	Actual Length	Watts		Nominal Length (in)	Actual Length	Watts		Nominal Length (in)	Actual Length	Watts		Nominal Length (in)	Actual Length	Watts	
		RGBX18	RGBWX18			RGBX18	RGBWX18			RGBX18	RGBWX18			RGBX18	RGBWX18
		SO	SO			SO	SO			SO	SO			SO	SO
12	8 12/16	4.6	5.7	47	--	--	--	82	--	--	--	117	--	--	--
13	12 11/16	4.6	5.7	48	--	--	--	83	--	--	--	118	--	--	--
14	--	--	--	49	48 2/16	17.4	21.9	84	83 9/16	29.8	37.1	119	119	40.9	51.2
15	--	--	--	50	--	--	--	85	--	--	--	120	--	--	--
16	--	--	--	51	--	--	--	86	--	--	--	121	--	--	--
17	16 10/16	6.1	7.5	52	--	--	--	87	--	--	--	122	--	--	--
18	--	--	--	53	52 1/16	18.9	23.7	88	87 8/16	31.1	38.7	123	122 15/16	42.1	52.8
19	--	--	--	54	--	--	--	89	--	--	--	124	--	--	--
20	--	--	--	55	--	--	--	90	--	--	--	125	--	--	--
21	20 9/16	7.6	9.4	56	56	20.3	25.4	91	--	--	--	126	--	--	--
22	--	--	--	57	--	--	--	92	91 7/16	32.4	40.3	127	126 14/16	43.3	54.3
23	--	--	--	58	--	--	--	93	--	--	--	128	--	--	--
24	--	--	--	59	--	--	--	94	--	--	--	129	--	--	--
25	24 8/16	9.1	11.3	60	59 15/16	21.7	27.1	95	--	--	--	130	--	--	--
26	--	--	--	61	--	--	--	96	95 6/16	33.4	41.6	131	130 13/16	44.5	55.9
27	--	--	--	62	--	--	--	97	--	--	--	132	--	--	--
28	--	--	--	63	--	--	--	98	--	--	--	133	--	--	--
29	28 7/16	10.6	13.2	64	63 14/16	23.0	28.8	99	--	--	--	134	--	--	--
30	--	--	--	65	--	--	--	100	99 5/16	34.6	43.2	135	134 12/16	45.7	57.4
31	--	--	--	66	--	--	--	101	--	--	--	136	--	--	--
32	--	--	--	67	--	--	--	102	--	--	--	137	--	--	--
33	32 6/16	11.7	14.6	68	67 13/16	24.4	30.5	103	--	--	--	138	--	--	--
34	--	--	--	69	--	--	--	104	103 4/16	35.9	44.8	139	138 11/16	46.9	58.9
35	--	--	--	70	--	--	--	105	--	--	--	140	--	--	--
36	--	--	--	71	--	--	--	106	--	--	--	141	--	--	--
37	36 5/16	13.1	16.5	72	71 12/16	25.8	32.3	107	--	--	--	142	--	--	--
38	--	--	--	73	--	--	--	108	107 3/16	37.2	46.4	143	142 10/16	48.0	60.4
39	--	--	--	74	--	--	--	109	--	--	--	144	--	--	--
40	--	--	--	75	--	--	--	110	--	--	--	--	--	--	--
41	40 4/16	14.6	18.3	76	75 11/16	27.1	33.9	111	--	--	--	--	--	--	--
42	--	--	--	77	--	--	--	112	111 2/16	38.4	48.0	--	--	--	--
43	--	--	--	78	--	--	--	113	--	--	--	--	--	--	--
44	--	--	--	79	--	--	--	114	--	--	--	--	--	--	--
45	44 3/16	16.0	20.1	80	79 10/16	28.4	35.5	115	--	--	--	--	--	--	--
46	--	--	--	81	--	--	--	116	115 1/16	39.7	49.6	--	--	--	--

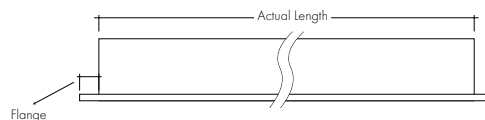

Voltage Drop Calculator

The below chart assumes nominal voltage of 24 Volts and a Voltage Drop Allowance of 3% through the wire

Wattage [W]	Maximum Wire Length From Power Supply to Start of Run [ft]						
	12 AWG	14 AWG	16 AWG	18 AWG	20 AWG	22 AWG	24 AWG
5	1088.2	684.4	430.3	270.6	170.2	107.1	67.3
10	544.1	342.2	215.1	135.3	85.1	53.5	33.7
15	362.7	228.1	143.4	90.2	56.7	35.7	22.4
20	272.0	171.1	107.6	67.7	42.6	26.8	16.8
25	217.6	136.9	86.1	54.1	34.0	21.4	13.5
30	181.4	114.1	71.7	45.1	28.4	17.8	11.2
35	155.5	97.8	61.5	38.7	24.3	15.3	9.6
40	136.0	85.5	53.8	33.8	21.3	13.4	8.4
45	120.9	76.0	47.8	30.1	18.9	11.9	7.5
50	108.8	68.4	43.0	27.1	17.0	10.7	6.7
55	98.9	62.2	39.1	24.6	15.5	9.7	6.1
60	90.7	57.0	35.9	22.6	14.2	8.9	5.6
65	83.7	52.6	33.1	20.8	13.1	8.2	5.2
70	77.7	48.9	30.7	19.3	12.2	7.6	4.8
75	72.5	45.6	28.7	18.0	11.3	7.1	4.5
80	68.0	42.8	26.9	16.9	10.6	6.7	4.2
85	64.0	40.3	25.3	15.9	10.0	6.3	4.0
90	60.5	38.0	23.9	15.0	9.5	5.9	3.7
96	56.7	35.6	22.4	14.1	8.9	5.6	3.5

Power Supplies

See fixture and power supply instructions & spec sheet for wiring information. Dimming possible in select models - view Luminii website for list of compatible dimmers.

For use with Warm Dim, WD68

Ordering Code Phase Dimming Power Supply 1% 120VAC - 277VAC

MODEL	INPUT CONTROL	ENVIRONMENT	WATTAGE	OUTPUT	OUTPUT CONTROL
PS- Power Supply, 120-277VAC	PH-Phase Dimming (Triac, ELV, MLV)	D-Dry	96-96 Watts	24-24 VDC	DC-Direct Current

MLV/ELV/TRIAC - 1% dimming, consult dimming compatibility chart [\(Link\)](#)

MODELS	96W
Length	8.25"
Width	4.10"
Depth	1.56"

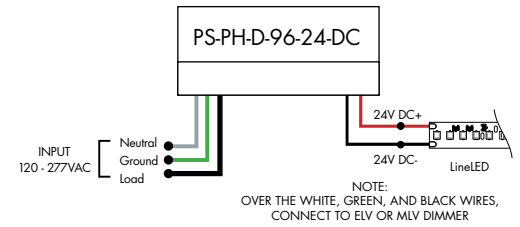

For use with Tunable White, TW68

Ordering Code DALI2 Dimming Power Supplies 0.1% 120VAC - 277VAC

MODEL	INPUT CONTROL	ENVIRONMENT	WATTAGE	OUTPUT	OUTPUT CONTROL
PS- Power Supply, 120-277VAC	DALI-DT8-DALI DT8 Tunable White (0.1%)	D-Dry	96-96 Watts	24-24 VDC	PWM-Pulse Width Modulation

MODELS	96W
Length	14.40"
Width	5.20"
Depth	2.60"

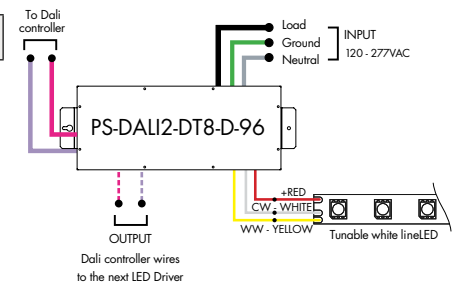

Athena DALI2-DT8 LED Driver

MODEL	INPUT CONTROL	ENVIRONMENT	WATTAGE	OUTPUT	FEATURE
PS- Power Supply, 120-277VAC	DALI-DT8-DALI DT8 Tunable White	D-Dry	96-96 W	24-24 VDC	AWNDR-Athena

MODELS	96W
Length	14.40"
Width	5.20"
Depth	2.60"

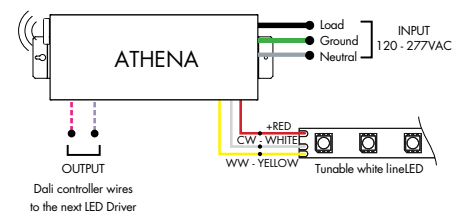

Power Supplies

See fixture and power supply instructions & spec sheet for wiring information. Dimming possible in select models - view Luminii website for list of compatible dimmers.

For use with Tunable White, TW68

Ordering Code VintageDim® 0 - 10V Dimming Power Supplies 120VAC - 277VAC

MODEL	INPUT CONTROL	ENVIRONMENT	WATTAGE	OUTPUT
PS - Power Supply, 120-277VAC	010V-WD - 0-10V Dimming, Standard Warm Dim Curve (with Tunable White LED) 010V-TW - 0-10V Dimming, Two Channel Control, Brightness and CCT1-CCT2 Ratio 010V-2CH - 0-10V Dimming, Two Channel Control, LED1 Brightness and LED2 Brightness 010V-WDX - 0-10V Dimming, Customizable Warm Dim Curve (with Tunable White LED) 010V-2CHX - 0-10V Dimming, Two Channel Control, Customizable Brightness and CCT1-CCT2 Ratio	D-Dry	96 - 96 Watts 3X96 - 3x96 Watts ¹	24 - 24 VDC

1 - 3x96 is only available with input control options 010V-WD and 010V-TW
 2 - Athena only available on 96 watts option

MODELS	96W	3X96
Length	14.40"	15.00"
Width	5.20"	6.62"
Depth	2.60"	4.56"

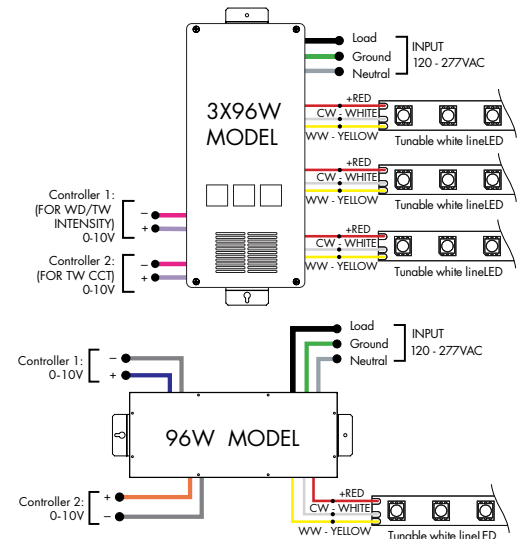

Athena 0-10V Warm Dim LED Driver

MODEL	INPUT CONTROL	ENVIRONMENT	WATTAGE	OUTPUT	FEATURE
PS - Power Supply, 120-277VAC	010V-WD - 0-10V Dimming, Standard Warm Dim Curve (with Dynamic White LED)	D-Dry	96-96 W	24-24 VDC	AWNDR-Athena

MODELS	96W
Length	14.40"
Width	5.20"
Depth	2.60"

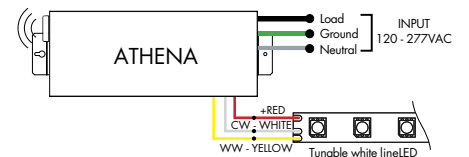

Athena 0-10V Two Channel LED Driver

MODEL	INPUT CONTROL	ENVIRONMENT	WATTAGE	OUTPUT	FEATURE
PS - Power Supply, 120-277VAC	010V-2CH - 0-10V Dimming Two Channel Control, LED1 Brightness and LED2 Brightness	D-Dry	96-96 W	24-24 VDC	AWNDR-Athena

MODELS	96W
Length	14.40"
Width	5.20"
Depth	2.60"

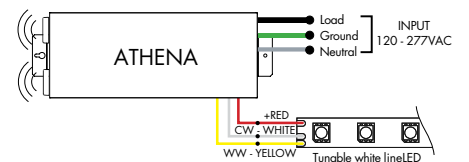

Power Supplies

See fixture and power supply instructions & spec sheet for wiring information. Dimming possible in select models - view Luminii website for list of compatible dimmers.

For use with RGB/RGBW, RGB42/RGBW36 or with Tunable White, TW68

Requires Controller

Ordering Code DMX Dimming Power Supplies 0.1% 120VAC - 277VAC

MODEL	INPUT CONTROL	ENVIRONMENT	WATTAGE	OUTPUT
PS-Power Supply, 120-277VAC	DMX-DMX (0.1%)	D-Dry	96-96 Watts 3X96-3X96 Watts	24-24 VDC

MODELS	96W	3X96
Length	14.40"	15.00"
Width	5.20"	6.62"
Depth	2.60"	4.56"

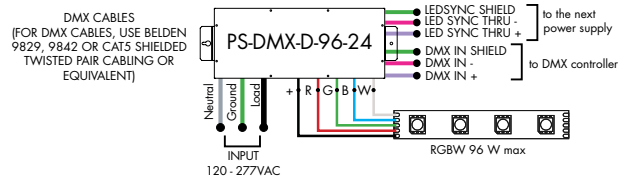
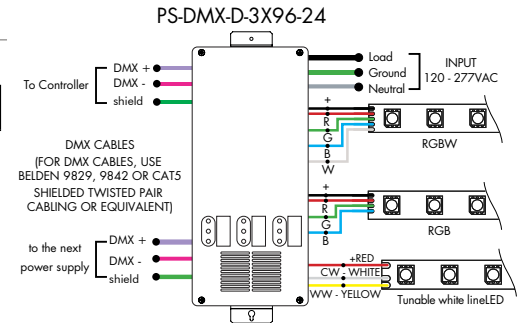

For use with RGB/RGBW/Pixel, RGB42/RGBW36/RGBX18/RGBWX18

Requires Controller and Decoder

Ordering Code Non-Dimming Power Supply 120VAC - 277VAC

MODEL	INPUT CONTROL	ENVIRONMENT	WATTAGE	OUTPUT
PS-Power Supply, 120-277VAC	ND-Non Dimming	D-Dry	96-96 Watts	24-24 VDC

MODELS	96W
Length	14.40"
Width	5.20"
Depth	2.60"

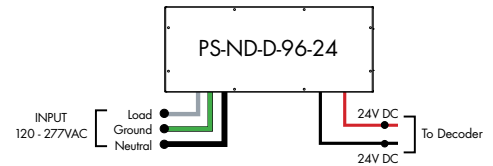

For use with RGB/RGBW/Pixel, RGB42/RGBW36/RGBX18/RGBWX18

Requires Controller and Decoder

Ordering Code Universal Dimming Power Supplies 1% 120VAC - 277VAC

MODEL	INPUT CONTROL	ENVIRONMENT	WATTAGE	OUTPUT
PS-Power Supply, 120-277VAC	UNI-0-10V Dimming, Phase Dimming	D-Dry W-Wet	30-30 Watts 60-60 Watts 96-96 Watts 3x96-3x96 Watts	24-24 VDC

Compatibility: View a complete list of compatible dimmers on product page [\(Link\)](#)

0-10V - 1% dimming
MLV/ELV/TRIAC - 1% dimming, consult dimming compatibility chart

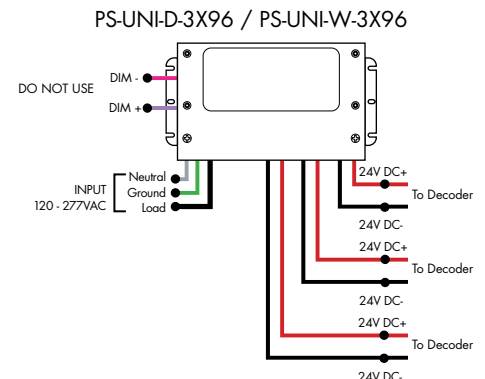
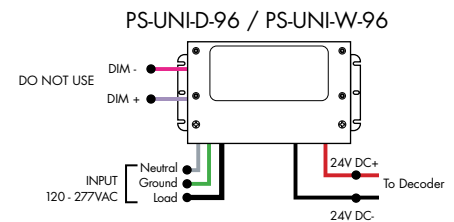

MODELS	PS-UNI-W-30W	PS-UNI-W-60W	PS-UNI-W-96W	PS-UNI-W-3X96W
Length	6.50"	7.40"	8.66"	11.85"
Width	3.73"	3.73"	3.73"	4.32"
Depth	1.61"	1.61"	1.61"	1.81"

MODELS	PS-UNI-D-30W	PS-UNI-D-60W	PS-UNI-D-96W	PS-UNI-D-3X96W
Length	8.77"	8.77"	8.11"	9.94"
Width	4.27"	4.27"	5.60"	7.61"
Depth	1.83"	1.83"	1.83"	2.02"

Controllers and Decoders

For use with Tunable White Power Supplies



MODEL

DTW-MC

DTW-MC - Tunable White controller

Tunable White wall-mount controller controls lighting fixtures, wireless control of TW lighting fixture. Fits in any standard US switch box. Includes all the outputs in the back of the controller.

Features

- Switch & dimming control function, control range > 20M.
- Smooth transition between light levels.
- Separately operate dimming and color temperature functions.
- Able to control 1 zone with endless receivers. Each receiver can maximally be controlled by 8 remotes.
- Power, temperature color and dimming functions operated by push button after receivers are connected.

Operating Voltage

3V DC battery

Color Parameters

- Brightness
- Saturation
- Fading



MODEL

TW-DMX

TW-DMX - DMX controller

Tunable White DMX wall-mount controller is a fully touch sensitive controller designed in accordance with standard protocol DMX512. Offers fast and accurate color temperature adjustment and brightness dimming of natural white, warm white and cold white. Designed with a touch color wheel, the DMX512 controller can adjust color temperature and brightness for all white LEDs smoothly and accurately. The DMX controller can control 1 zone with endless decoders.

Features

- 1 zone
- 6 color scenes
- DMX Control
- Touch Sensitive Glass Surface
- Dimming and Speed Control
- Memory Function
- Easily Fits Standard US Switch Boxes

Operating Voltage

12 - 24V DC

Color Parameters

- Brightness
- Saturation
- Primary colors
- Fading
- Color changing speed



MODEL

SLD-DIMTW

SLD-DIMTW - Tunable white LED dimming module

The SLD DimTW is a constant voltage warm dimming LED dimming module. The unique dimming module accepts 0-10V control and mimics a smooth, incandescent dimming curve.

Features

- Flicker free 0-100% dimming
- High efficiency up to 97%
- High precision dimming ratio:>1:1000
- Fully isolated plastic housing
- Comply with EN55015 and FCC part 15 without additional input filter and capacitors
- compact size, high reliability
- 3 years warranty

Operating Voltage

8-48 VDC

Controllers and Decoders

For use with Tunable White, RGB/RGBW Power Supplies



MODEL

RGBW-RC-R

RGBW-RC-R - RGBW receiver

The RGBW receiver is easily paired with controller by the click of a button. Receiver can be reset to factory settings at any time.

Each receiver can store one static RGB color, one color sequence, and one brightness setting for the white LED strip. Receivers assigned to the same scene within the same zone will have the same LED static color and color sequence.

Operating Voltage
12-36 VDC

Power Capacity
up to 96W at 24V

Operating Temperature Range
from -4°F to +122°F in case



MODEL

RGBW-SR

RGBW-SR - RGBW signal repeater

Extends identical signal when connected in series to an RGBW LED control system. The RGBW signal repeater works with Luminii RGB and RGBW controllers, receivers, and decoders.

RGBW signal can be extended indefinitely when adequate power supply (not included) is connected to the system.

Operating Voltage
12-36 VDC

Power Capacity
up to 96W at 24V

Operating Temperature Range
from -4°F to +122°F in case



MODEL

DDMX-RGBW

DDMX-RGBW - DMX decoder

Translates controller DMX512 programs for RGB and white LED strips.

Unique DMX address for the decoder can be set easily and displayed by the numeric display on the case. Changing and resetting the DMX address requires manual input.

Use power repeater to expand output.

Operating Voltage
12-36 VDC

Power Capacity
up to 96W at 24V

Operating Temperature Range
from -4°F to +122°F in case

Controllers and Decoders

For use with RGB/RGBW Power Supplies

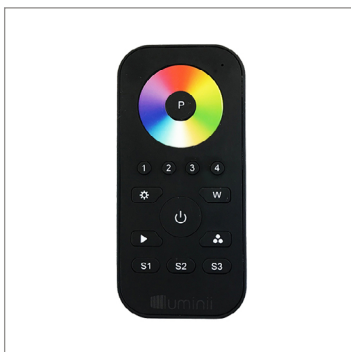

MODEL

RGBW-MC3

RGBW-MC3 - 4-zone RGBW controller

Easy to operate wireless interface suitable for static or color changing scenes. Control 4 different color zones separately or at the same time. RGBW receiver (RGBW-RC-R) required for operation. Assign multiple receivers per zone to cover a large area.

Color wheel enables highly stable and sensitive color control functionality. Create your own color changing sequences with ease and flexibility.

Power

qty 3 AAA batteries

Scenes

up to 4 unique zones

Signal

Wireless (RF)

Energy Saving

Deactivates after 10 seconds of inactivity

Color Parameters

- Brightness
- Saturation
- Primary colors
- Speed of color changing sequence
- Fading

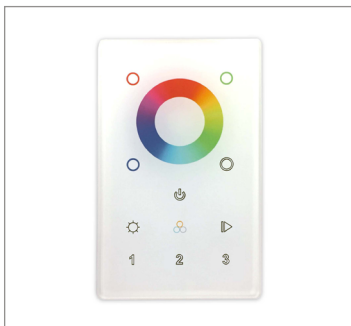

MODEL

ZONES

COLOR

DMX - DMX Controller

3Z - Three Zone
1Z - One Zone

RGBW - Red, Green, Blue, & White

DMX /Wireless RGB-W wall-mount controller controls DMX lighting fixtures, wireless control of RGB-W lighting fixture or use both simultaneously. Fits in any standard US switch box. Includes all the outputs in the back of the controller.

Control brightness levels with a single touch, personalize and memorize 3 different scenes, and even create 3 variations of white.

Features

- 2 in 1 in-Wall Controller: DMX Control or Wireless RGB-W
- 65,000 Color Options, Dimming and Speed Control
- Memory Function
- 50 Foot Wireless Range
- Easily Fits Standard US Switch Boxes
- Touch Sensitive Glass Surface
- Includes 10 Built in Programs, or Create and Play Your Own

Operating Voltage

12 - 24V DC

Color Parameters

- Brightness
- Saturation
- Primary colors
- Fading
- Color changing speed

For use with Tunable White, RGB/RGBW, Pixel Power Supplies

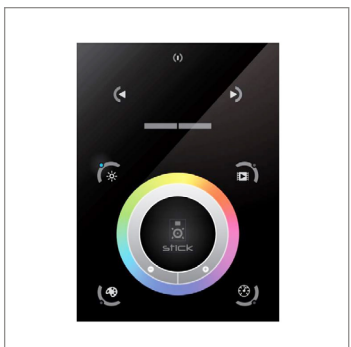

MODEL

TSDMX-E

TSDMX-E - Touchscreen DMX controller

Programmable advanced DMX512 lighting controller featuring a touch-screen interface. Operates as stand alone controller or integrated with most architectural lighting control systems. Can controller endless DMX512 enabled devices.

Mounts to standard single or dual gang wall box with the included power supply inside the junction box. Terminal block design for power and data connections.

Features

- Sleek glass design which sits 0.43" from the wall
- Graphical color display to show selected environment
- Color/dimmer/speed palette
- Color temperature mixing
- Touch sensitive buttons. No mechanical parts
- Touch sensitive wheel allows for accurate color selection
- Multi-zone microSD memory
- Multi-room control with 500 scenes, 10 zones
- 1024 DMX channels. Control 340 RGB fixtures
- USB & Ethernet connectivity for programming and control

Power Supply

7 VDC (included)

Programmability

PC, Mac, Tablet, Smartphone

Output Signal

DMX512 (1024 channels)

Color Parameters

- Brightness
- Saturation
- Speed of color changing sequence
- Fading / dimming / brightness

Controllers and Decoders

For use with Pixel Power Supplies



MODEL

SR-DMX-SPI

SR-DMX-SPI - Smart Pixel Decoder

The SR-DMX-SPI is a smart LED pixel decoder that controls RGB/RGBW pixel LED strips with SPI signal. Designed with an OLED backlit panel, the pixel controller allows for easy configuration of most settings. Four push buttons are available for control of the LED functions.
*For pixel only.

Features

- 2 in 1 in-Wall Controller: DMX Control or Wireless RGB-W
- SPI signal output for RGB/RGBW pixel light control
- DMX512 controllable and RF/WIFI remote controllable
- Capable of addressing up to 1020 RGB pixels & 765 RGBW pixels
- OLED panel allows for easy configuration

Operating Voltage

12 - 36V DC

Power capacity

up to 96W at 24V

Operating temperature range

from -4°F to +122°F in case

For use with Tunable White, RGB/RGBW Power Supplies



MODEL

DDMX-5CH-RDM-PRO

DDMX-5CH-RDM-PRO-DMX512 Decoder

DMX512 decoder with RDM functionality features 5 PWM output channels with common anode. High PWM output frequency range allows the product to be used in HD video conferencing spaces. All DMX products to be installed per DMX512 Standard.

Power

96 Watt

Inputs

RJ45, XLR-5Pin, Terminal Block

DMX Channels

1 to 5 settable

PWM Output Resolution Ratio

8 or 16 bit

PWM Output Frequency

500Hz - 30KHz

Output Dimming Curve Gamma Value

0.1 ~ 9.9



MODEL

RGBW-WI-R

RGBW-WI-R - WIFI generator

RGBW-WI-R creates a local network that enables any electronic device (phone, tablet, etc.) to control the RGB/W strip connected to a RGBW-RC-R receiver.

The control functions are achieved through a free application download for Android and iOS devices called REALCOLOR.

Operating Voltage

12-36 VDC

Power Supply

PI-130-24 (included)

Operating Temperature Range

from -4°F to +122°F in case