



**Features**

The KM Channel linear aluminum extrusion has been designed to fit many LED lighting needs. Multiple mounting and lens options allow for great flexibility and adaptability for any application. Extrusion and diffuser lenses are also field cuttable. Substantial aluminum mass in profile provides excellent heat sink for high power LEDs. Channels come with specified Mounting Clips and End Caps.

**Finish**

Silver Anodized, White, Black, Bronze

**Diffuser Lens**

Polycarbonate, snap-in-place, UV resistant

**Mounting**

Multiple mounting clips

**Warranty**

7 Years

**Declare.** MADE IN U.S.A.

**Product Dimensions**

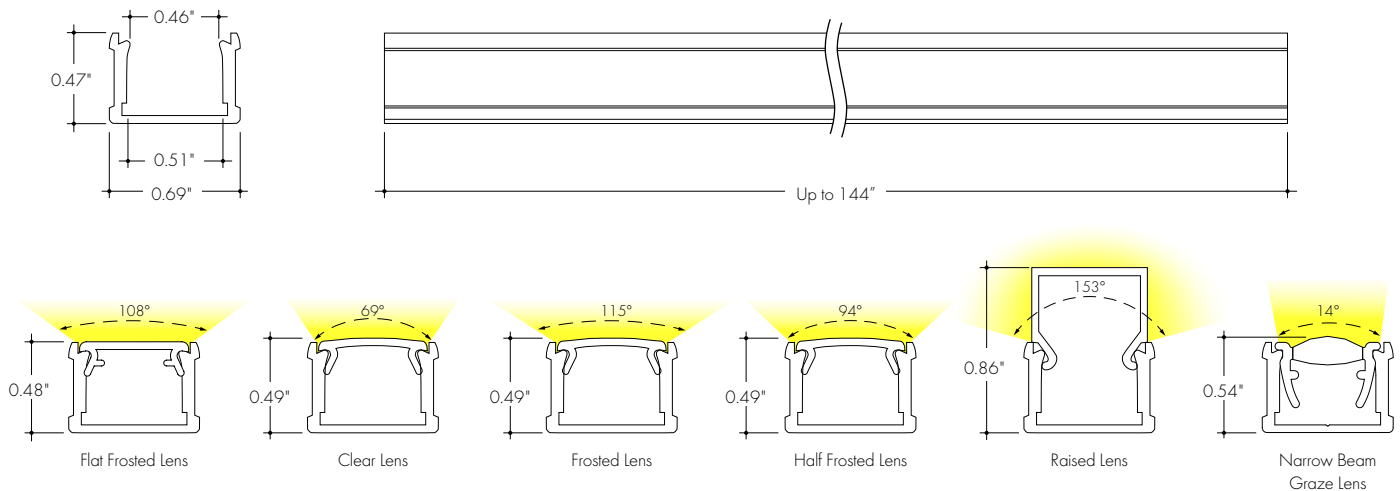

**INCLUDED MOUNTING ACCESSORIES**

EXTRUSION LENGTH	MOUNTING CLIPS (ALL TYPES)	ENDCAP PAIR
48"	3	1
72"	3	1
96"	4	1
120"	4	1
144"	5	1

Each pair of endcaps includes 1x H3 (no wire feed hole) and 1x H4 (with hole) where applicable. Additional endcaps and mounting clips are available for purchase.

**TRANSMISSION PERCENTAGE**  
(COMPARED TO LED TAPE WITHOUT CHANNEL)

LENS	TRANSMISSION %						
	LENS ONLY	BLBK	BLS	BLWH	GSBK	GSS	GSWH
Clear	82%	24%	32%	48%	44%	56%	64%
Half Frosted	68%	20%	27%	40%	37%	46%	53%
Raised	58%	N/A	N/A	N/A	N/A	N/A	N/A
Narrow Beam Grazer	56%	16%	22%	33%	30%	38%	44%
Flat Frosted	52%	15%	21%	31%	28%	35%	41%
Frosted	45%	13%	18%	26%	24%	31%	35%

More details of the Blade Louver and Glare Shield accessory on page 2. See LED tape spec sheet for lens dotting characteristics & compatibility. Raised lens not compatible with the Blade Louver or Glare Shield.

**Ordering code**

MODEL	LENGTH	LENS	MOUNTING <sup>2</sup>	FINISH <sup>4</sup>
KMC - KM Channel <sup>1</sup>	48 - 48" 72 - 72" 96 - 96" <sup>3</sup> 120 - 120" <sup>3</sup> 144 - 144" <sup>3</sup>	C - Clear F - Frosted HF - Half Frosted GR - Narrow Beam Grazer R - Raised FF - Flat Frosted	FC - Fixed Clip FC45 - Fixed Clip 45° A - Adjustable Hinge Mounting EFC - Tamper Resistant Fixed Clip	BASE SA - Silver Anodized  POWDER COAT BK - Black BZ - Bronze WH - White

1 - End Caps are included with channel, one of H3 (no hole) and one of H4 (with hole). Order additional End Caps as necessary.  
2 - Mounting Clips are included with channel. Refer to chart above for provided mounting clip quantities. Order additional Mounting Clips as necessary.

3 - For Channels and Lenses over 96", incremental shipping charges will apply.  
4 - Powder Coat finishes may have extended lead times. Custom RALs are available, please consult Inside Sales with specific request.

## Mounting Clips

All Channels come with a specified set of Mounting Clips and End Caps, see Ordering Code for details. Order additional Mounting Clips and End Caps as necessary.

### MB-KMSC-XX Fixed mounting clip -FC

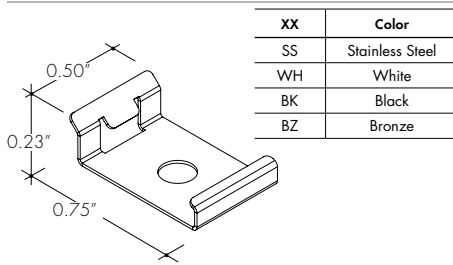

### MB-KMSC-45-XX Fixed mounting clip 45° -FC45

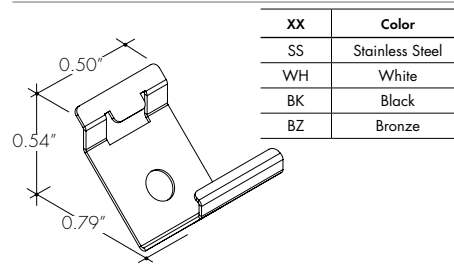

### MB-KMSC-A-XX Adjustable mounting clip, up to 90° -A

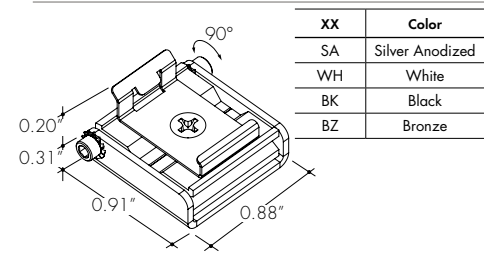

### MB-KMSC-EFC-SS Tamper Resistant Fixed Clip -EFC

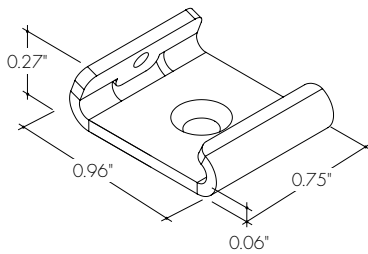

## Glare Shield and Blade Louver Accessory

### LV-GS-KMSC-24-XX Glare Shield reduces glare at high angle, field cuttable. Also available with complete fixture, use ordering code -GSXX

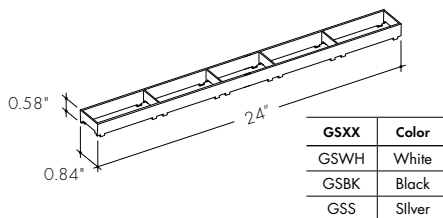

### LV-BL-KMSC-24-XX Blade Louver reduces glare at high angle in two directions Also available with complete fixture, use ordering code -BLXX

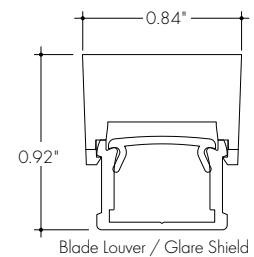
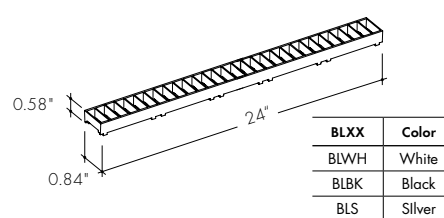

All Channels come with a specified set of Mounting Clips and End Caps, see Ordering Code for details. Order additional Mounting Clips and EndCaps as necessary.

### End Caps

For Clear, Frosted, Half-Frosted, or Flat Frosted Lens options.

**EC-KMC-F-H3-XX**  
End Cap

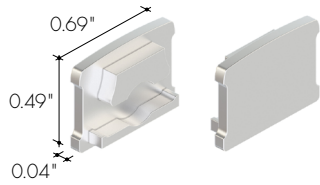

**EC-KMC-F-H4-XX**  
End Cap with slot opening

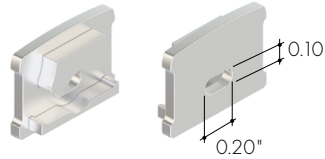

**EC-KMC-F-H8-XX**  
End Cap with powerfeed opening

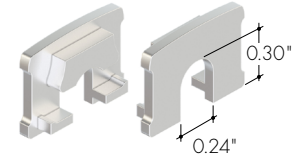

XX	Color
SA	Silver Anodized
WH	White
BK	Black
BZ	Bronze

### End Caps

For Graze Lens option

**EC-KMC-GR-H3-SA**  
End Cap

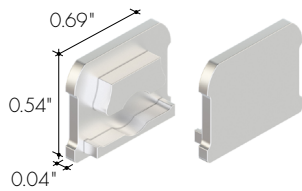

**EC-KMC-GR-H4-SA**  
End Cap with slot opening

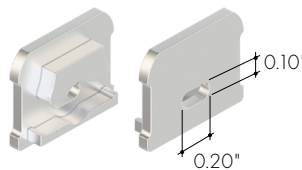

**EC-KMC-GR-H8-XX**  
End Cap with powerfeed opening

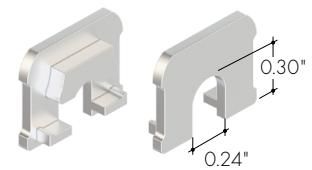

XX	Color
SA	Silver Anodized
WH	White
BK	Black
BZ	Bronze

### End Caps

For Raised Lens option

**EC-KMC-R-H3-XX**  
End Cap

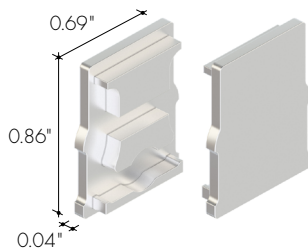

**EC-KMC-R-H4-XX**  
End Cap with slot opening

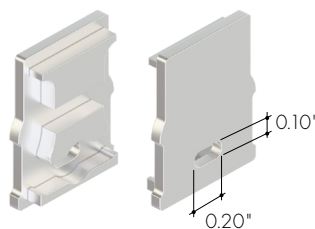

**EC-KMC-R-H8-XX**  
End Cap with powerfeed opening

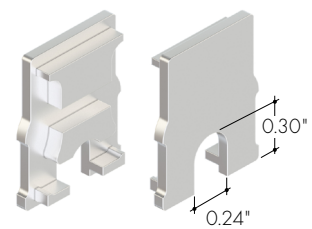

XX	Color
SA	Silver Anodized
WH	White
BK	Black
BZ	Bronze

