

Hero adjustable luminaire with LightShift technology allows for 40 degree tilt and 360 degree pan beam adjustment without moving or rotating the luminaire body. Harmonious integration into the architecture and flexible installation into the tightest spaces. Fixed light emitting face orientation, precision optics, adaptive glare baffle, and advanced anti-reflective materials provide for exceedingly low glare. Available with a wide range of beam characteristics, shapes, colors, and mounting configurations.

Mounting	lighting junction box canopy	Dimming	Phase 1%, 0-10V 1%/0.1%, or DALI 0.1%
Size	10 LED, 6 LED	Beam Angle	11°, 14°, 23°, 36°, 44°
Shape	rounded or rectangular	Location	Dry and Damp
Stem	field cut stem, up to 4' long, standard 7" offset	Lifetime	60,000 hours
Operating Power	120-277 V, 50-60 Hz, power factor > 0.9	Warranty	5 years

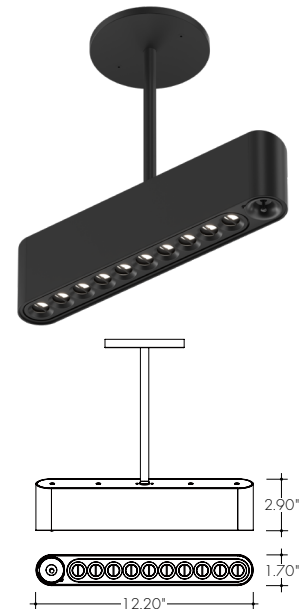

Technical Information

MODEL:	Hero	
Light Output (3000K) <small>*HO uses 1.2 multiplier</small>	SO	1290 lm (10 LED), 775 lm (6 LED)
	HO	1548 lm (10 LED), 930 lm (6 LED)
Efficacy	58 lm/W	
Color Temperature	2700K, 3000K, 3500K, 4000K	
CRI	92	
Wattage	SO	23W (10 LED), 14W (6 LED)
	HO	28W (10 LED), 17W (6 LED)
Beam Tilt	Rated to ±40 deg	
Beam Pan	Infinite (360 Deg with no stops)	

CCT	Lumens	CRI		TM-30		CBCP				
		R _a	R _g	R _f	R _g	LS11	LS14	LS23	LS36	LS44
2700K	1220	92	65	89	103	27712	18379	7206	3212	2375
3000K	1290	96	79	94	101	29252	19400	7606	3390	2507
3500K	1335	95	81	94	102	30330	20115	7886	3515	2599
4000K	1390	94	74	92	99	32724	21703	8509	3792	2805

CCT	Lumens	CRI		TM-30		CBCP				
		R _a	R _g	R _f	R _g	LS11	LS14	LS23	LS36	LS44
2700K	732	55	39	53	61	16627	1103	4323	1927	1425
3000K	774	57	47	56	60	17551	11640	4563	2034	1504
3500K	801	57	48	56	61	18198	12069	4731	2109	1599
4000K	834	56	44	55	59	19634	13021	5105	2275	1683

*HO multiplier = 1.2x

Name	BEAM				
	LS11	LS14	LS23	LS36	LS44
Width (Diameter)	11°	14°	23°	36°	44°
Field Angle	20°	25°	38°	59°	69°

Ordering Code

MODEL	TYPE	SHAPE	OUTPUT	CCT	OPTIC	FINISH
HER06 - Hero Adjustable 6 LED HER10 - Hero Adjustable 10 LED	MP - Monopoint	RD - Rounded Endcaps SQ - Squared Endcaps	SO - Standard Output HO - High Output ¹	27K - 2700K 30K - 3000K 35K - 3500K 40K - 4000K	LS11 - 11 Degree LightShift LS14 - 14 Degree LightShift LS23 - 23 Degree LightShift LS36 - 36 Degree LightShift LS44 - 44 Degree LightShift	WH - White BK - Black
CANOPY SHAPE	STEM CONFIGURATION	DRIVER				
RD4 - 4" Round Canopy	SSS - Straight Stem Standard (7") SS2 - Straight Stem, 2" SS4 - Straight Stem, 4"	PHSD - Forward/Reverse Phase, 1% Dim, 120V/277V ² O10S - 0-10V, 1% Dim, 120/277 O10L - eldoLED, 0-10V, Linear, 0.1% Dim O10G - eldoLED, 0-10V, Log, 0.1% Dim DALI - eldoLED, Dali Protocol 2, DT-6, 0.1% Dim				

1. HO 1.2x multiplier
2. Not compatible with HERO6

Product Dimensions

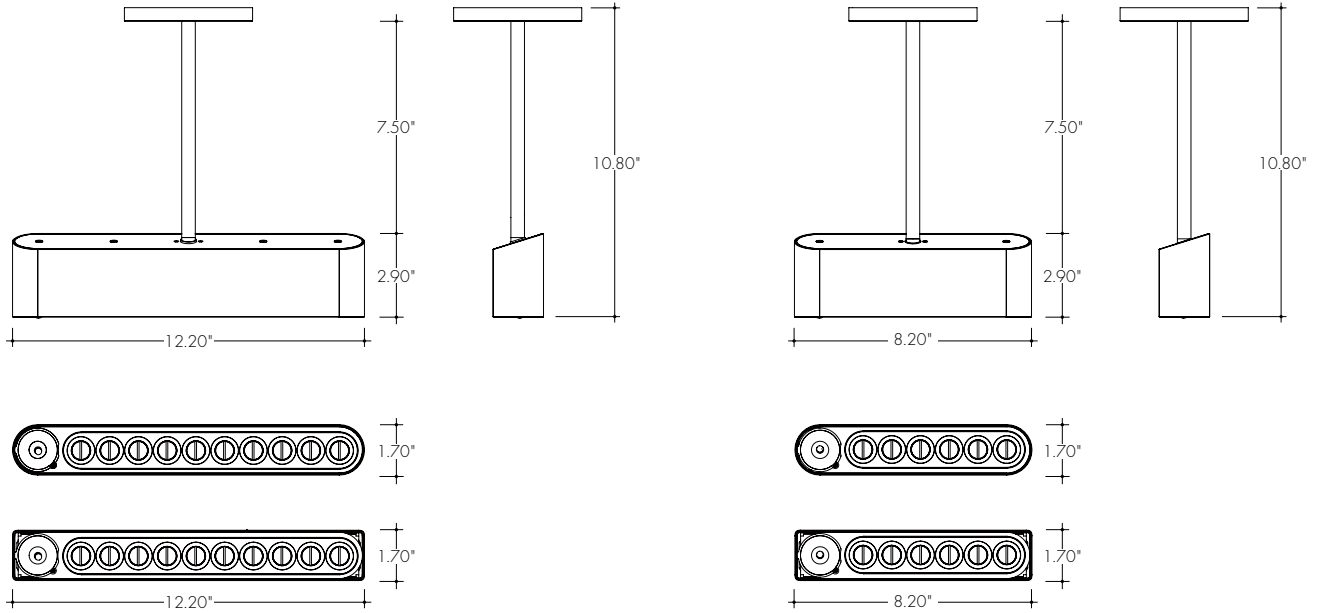

Shape

RD
Rounded Endcaps

SQ
Squared Endcaps



Finish

BK
Black

WH
White

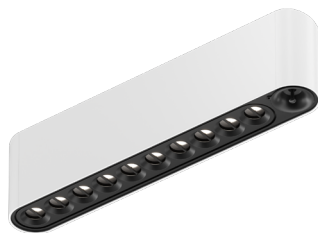

Photometry

A-Downlight



B-30 Degree Beam Adjustment

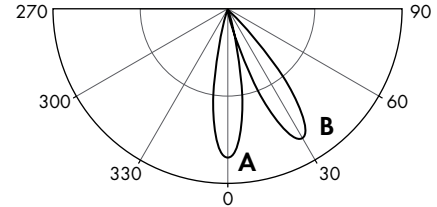

*Beam steering achieved with intuitive joystick movement.

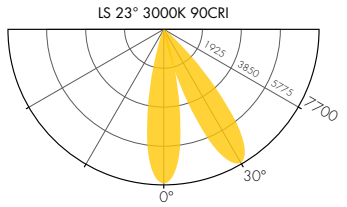
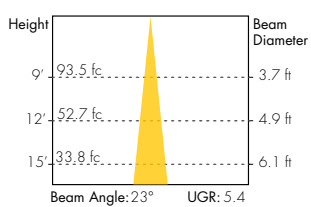
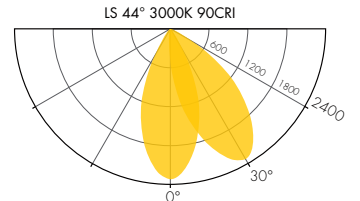
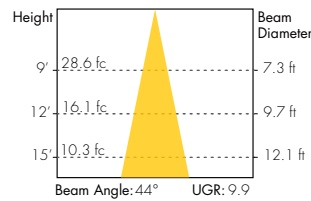
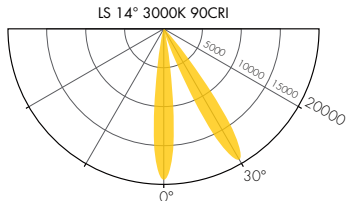
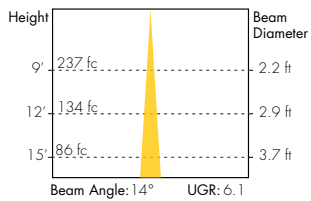
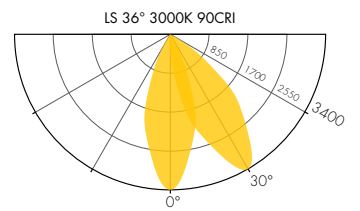
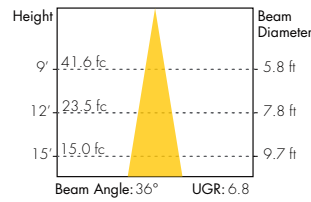
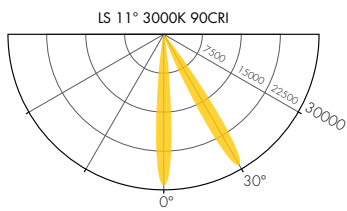
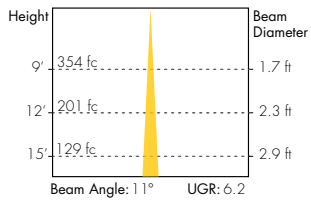

Family

