

glint  
by luminii

# HERO

Precision Placement, Perfect Illumination



# Revolutionizing Simplicity in Lighting Design

Hero sets a new standard as the first luminaire that adjusts light direction effortlessly, all without moving the fixture itself. With a built-in joystick, you have complete control over the direction of light, maintaining the sleek design and glare cut-offs of the luminaire with absolute stillness.



*Hero monopoint rounded installed between suspended acoustic ceiling panels*

# Precision Placement, Perfect Illumination

## Seamless Architectural Integration

Tailor Hero to seamlessly blend with the lines of your space while offering up to 40° of beam adjustment for flexible illumination. Multiple Hero luminaires can be aligned to work harmoniously together with your architectural vision. Its unique design, free from the need for physical movement during adjustments, allows it to fit into tight spaces where traditional luminaires cannot.

## Beautiful Light

Hero delivers light with smooth, pleasing beam shapes, exceptional color uniformity, and minimal glare. Our in-house designed optics ensure consistent photometrics at every beam width, maintaining excellent visual comfort throughout its adjustable range.

## Exceptional Visual Comfort

At the heart of Hero is our commitment to managing glare by preventing its creation altogether. Without the need for tilting adjustments, Hero avoids casting harsh glare onto neighboring fixtures, recesses, and slots, or into your eyes. Its inherently glare-free design, coupled with precision optics and advanced materials, minimizes stray light while an adaptive baffle ensures optimal cut-off without the need for additional accessories.

## Unrivaled Simplicity

Despite its advanced technology, Hero embodies pure simplicity. With an intuitive joystick and single lock mechanism that are always cool to the touch, adjusting Hero is effortless. World-class beam quality and visual comfort are guaranteed with every use.

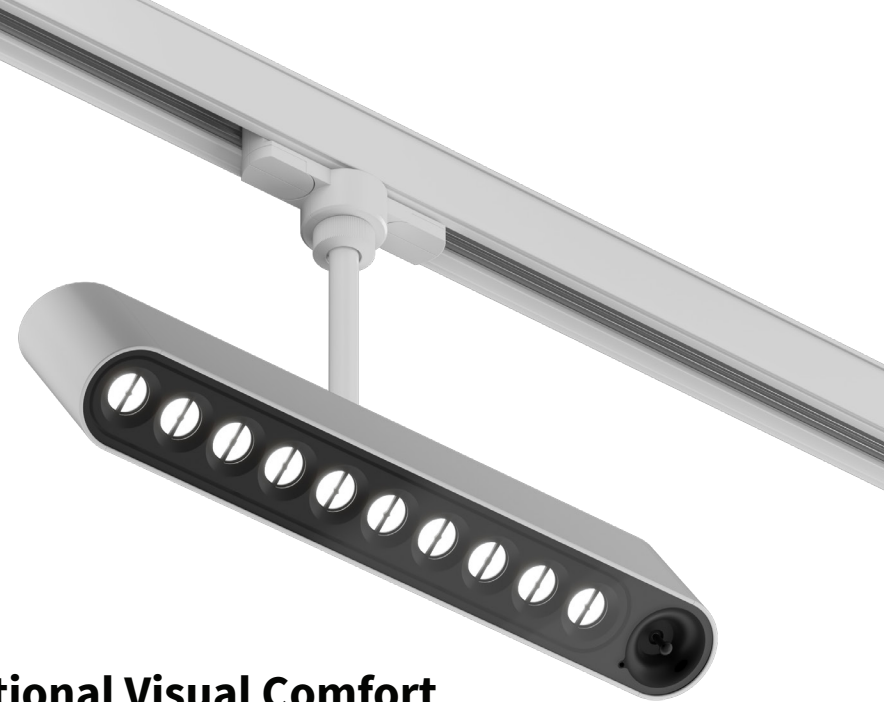

# Unmatched Capability

Hero not only offers adjustable light with unmatched visual comfort but also integrates seamlessly into architectural designs in ways previously unimaginable. Its core innovation lies in decoupling the direction of the fixture from its light emission, opening unprecedented possibilities.

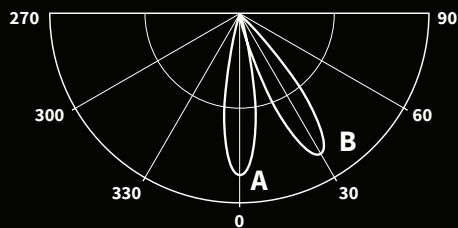
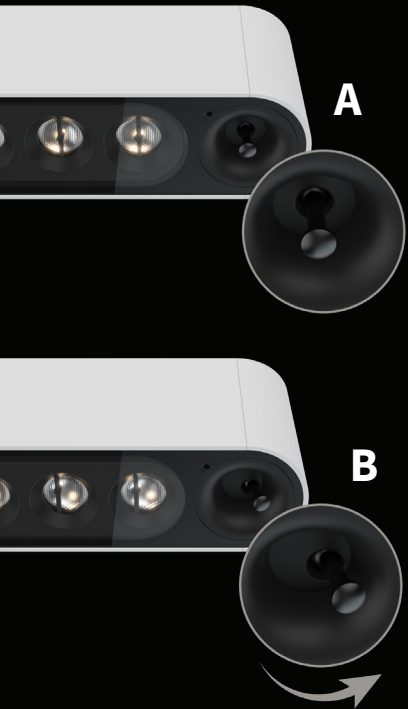

## Optical Ventriloquism

The true power of Hero lies in its ability to defy traditional photometric constraints. Redirect Hero's light away from occupants for zero glare while illuminating subjects up to 40° away in all directions. Direct light sideways while the fixture remains fully recessed in the ceiling, eliminating wasted light, and reflected glare of louvers and baffles.

**With Hero, the possibilities are limitless. Harness the power and place the light exactly where it's needed.**

# Adjustable Profile Size

Hero Track, Monopoint, Grille, and Wall Mount are all available in either a 6 or 10 adjustable profile size.

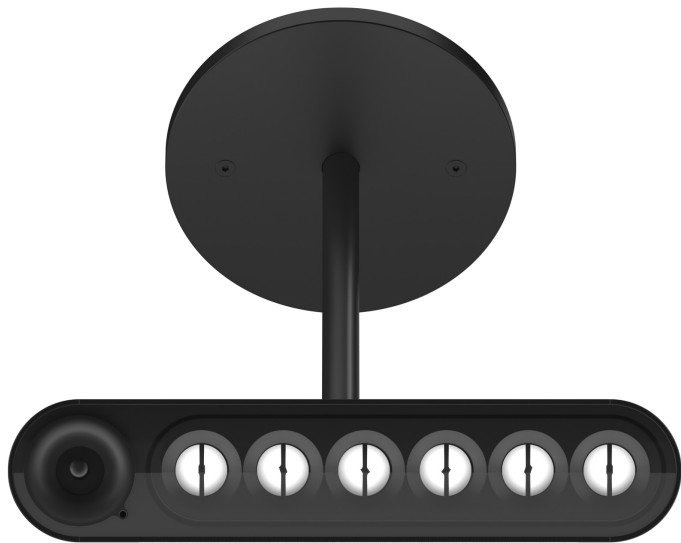

6 Emitter Hero Monopoint

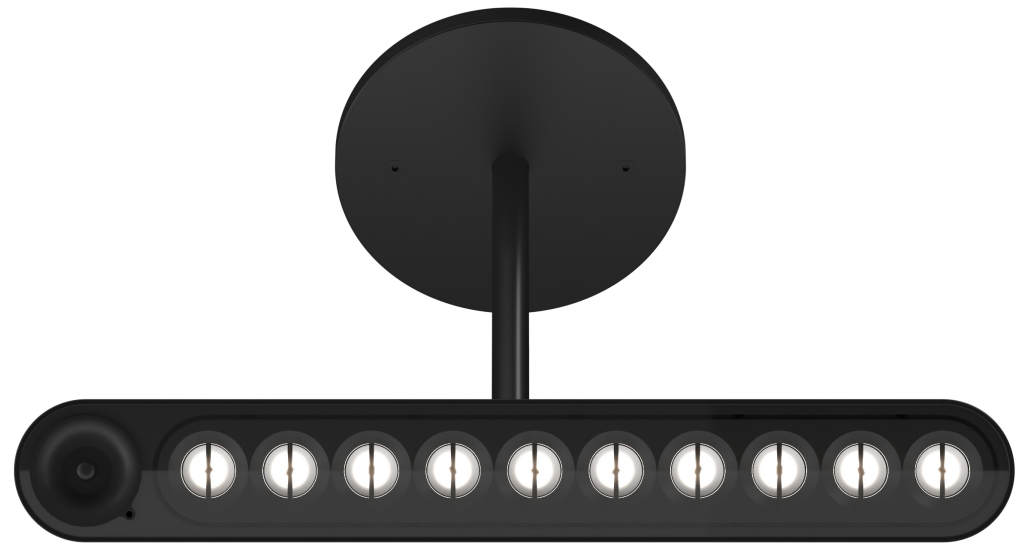

10 Emitter Hero Monopoint

# Explore the Hero Family



## Hero Track

Flexible two and three circuit track systems delivering versatility without the chaos and glare of cans pointing in different directions.



## Hero Monopoint

Graceful monopoint and duopoint luminaires delivering adjustable versatility from clean and simple fixed installation points.



## Hero Grille

Harmoniously integrates into architecturally designed slat ceilings featuring enhanced control, precise optics, an adaptive glare baffle, and advanced anti-reflective materials for minimal glare.

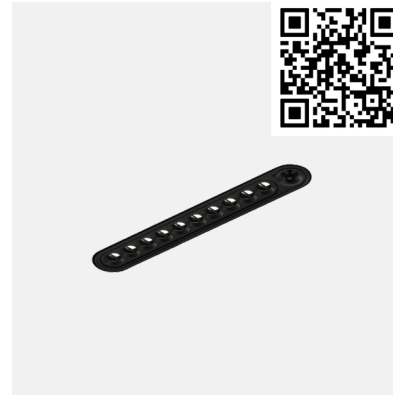

## Hero Recessed

Subtle recessed luminaires delivering powerful adjustability up to 40° from fully-recessed fixtures with no glare in the recess.

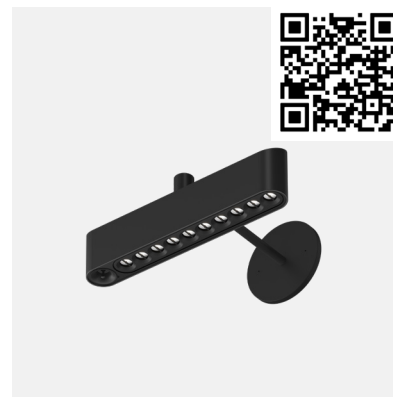

## Hero Wall

An adjustable wall monopoint with LightShift technology provides for beam adjustment with a joystick actuated internal mechanism that does not move or reorient the luminaire body.



Hero Track



Hero Monopoint



Hero Grille



Hero Recessed

# Performance

Glint exists to beautifully illuminate spaces for improved well-being while consuming minimal space and resources. Our products disappear into the architecture to provide exceptional light utilization and visual comfort, never drawing undue attention to themselves.

## Photometrics

**Light Output** Up to 1548 lumens @ 3000K

**Efficacy** 58lm/W @ 3000K

**Color Temperature** 2700K, 3000K, 3500K, or 4000K

**Color Rendering** 92CRI

**Beam Width** 11°, 14°, 23°, 36°, 44°

## Electrical

**Electrical** 23 W nominal, 120-277V 50/60Hz

**Dimming** 1% 0-10V, DALI-2, or phase; 0.1% 0-10V and DALI-2

## Adjustments

**Beam Adjustment Range** ± 40° rated tilt, infinite pan

**Fixture Orientation** Straight or inclined 35°, field reconfigurable

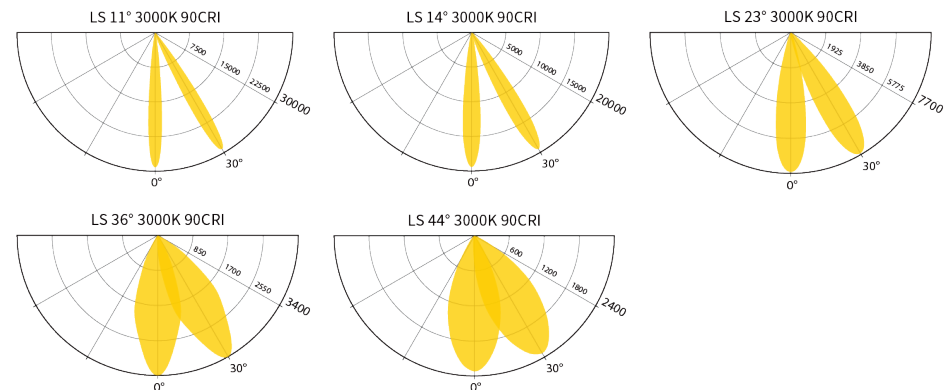

## Mechanical

**Mounting**

**Track:** 2 Circuit

**Monopoint:** 4" round

**Recessed:** New construction, suspended ceiling

**Grille:** Standard and custom brackets for wood slat and millwork ceilings



Hero grille installed in paneled wood ceiling  
Glint by Luminii







# SEE THE LIGHT, BE INSPIRED

## Stay Informed:

Be the first to know about Glint updates, exclusive offers, and lighting trends. Sign up for our newsletter to stay informed and inspired.

**Phone:** 224-333-6033

**Email:** [Info@Luminii.com](mailto:Info@Luminii.com)

**Website:** [Luminii.com/contact](http://Luminii.com/contact)

**Find an Agent:** [Luminii.com/find-an-agent](http://Luminii.com/find-an-agent)



LEARN MORE ABOUT  
GLINT LIGHTING



VISIT LUMINII.COM



CONTACT US