

**Features**

- 24VDC Class 2 fixtures made to order up to 144". Fixtures can be linked up to 37' depending on output
- Suitable for undercabinet, surface mount, and direct view applications
- Suitable for installation in the storage area of a clothes closet on outputs 5.7W/ft or less, NEC compliant for the USA only.
- Class two listed for damp locations.
- Proprietary strong bond solder method handles up to 50 lbs of pull force on wire leads and connectors.
- Average Life (L70): 50,000hrs
- Tunable White allows individual control of CCT and output, can be paired with Vintage Dim power supply for warm dim effect.
- Warm Dim follows the incandescent dimming curve and is compatible with MLV, ELV, and Incandescent dimmers
- RGB offers balanced output across the color gamut and a true white with RGBW
- Smart Pixel allows for infinite color combinations with cascading and chasing effects.
- 7 year warranty

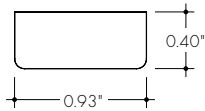
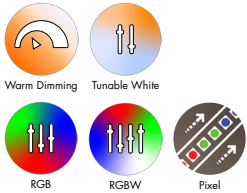

**Finish Options** (see page 3 for additional information)

- Powder Coat**     Black     Bronze     White
- Premium**     Matte Black     Warm Nickel     Aged Brass  
 Polished Gold     Chrome



**Technical Information**

TYPE	Warm Dim			Tunable White			RGB		RGBW		Pixel	
	WD51 (18K-30K)			TW51 (27K-65K)			RGB42		RGBW36		RGBX18	RGBWX18
OUTPUT OPTIONS	SO	HO	VHO	SO	HO	VHO	SO	HO	SO	HO	SO	SO
Lumens Output (3000K) (All On w/ Frosted Lens)	122 lm/ft	257 lm/ft	366 lm/ft	272 lm/ft	337 lm/ft	457 lm/ft	137 lm/ft	201 lm/ft	138 lm/ft	228 lm/ft	110 lm/ft	166 lm/ft
Average Power Consumption (for a 4" section)	2.3 W/ft	4.7 W/ft	6.9 W/ft	4.4 W/ft	5.4 W/ft	7.6 W/ft	4.5 W/ft	8.3 W/ft	4 W/ft	7.6 W/ft	4.5 W/ft	5.7 W/ft
Efficacy	53 lm/W	55 lm/W	53 lm/W	62 lm/W	62 lm/W	60 lm/W	30 lm/W	24 lm/W	35 lm/W	30 lm/W	24 lm/W	29 lm/W
Max Run Length (in series)	37 ft	22 ft	15 ft	27.9 ft	22 ft	15 ft	28ft	14ft	26ft	13ft	30ft	20ft
Ambient Operating Temperature Range*	-4°F - 122°F (-20°C - 50°C)		-4°F - 104°F (-20°C - 40°C)	-4°F - 122°F (-20°C - 50°C)		-4°F - 104°F (-20°C - 40°C)	-4°F - 122°F (-20°C - 50°C)    -4°F - 95°F (-20°C - 35°C)		-4°F - 122°F (-20°C - 50°C)    -4°F - 104°F (-20°C - 40°C)		-4°F - 122°F (-20°C - 50°C)	-4°F - 122°F (-20°C - 50°C)
Control/Dimming Protocol	0-10V, DALI, DALI2, MLV (Triac), ELV, Incandescent			0-10V, DMX, DALI-DT8			DMX, DALI-DT8		DMX, DALI-DT8		SPI Protocol UCS 2903    SPI Protocol UCS 2904	

\* Ambient Operating Temperature Range to maintain L70 of 50k+ hours in normal mounting conditions for the fixture. Exceeding Ambient Operating Temperature Range may result in decreased life/output. Consult Technical Support for specific inquiries.

**Warm Dim (WD51)**

CCT	Multiplier (ref. - 18K30K)	TM-30				
		CRI	R <sub>f</sub>	R <sub>g</sub>	R <sub>9</sub>	
18K24K	1800K	0.90	92	85	91	86
	2400K		96	95	104	97
18K27K	1800K	0.97	92	85	91	86
	2700K		96	95	104	96
18K30K	1800K	1.00	92	85	91	86
	3000K		95	95	104	90

**Tunable White (TW51)**

CCT	Multiplier (ref. - 27K65K)	TM-30				
		CRI	R <sub>f</sub>	R <sub>g</sub>	R <sub>9</sub>	
18K30K	1800K	0.78	92	85	91	86
	2400K		95	93	106	98
	3000K		97	94	104	95
27K65K	2700K	1.00	97	95	103	93
	4200K		96	93	105	95
	6500K		91	90	101	63

**RGBW (3000K)**

Tape	TM-30			
	CRI	R <sub>f</sub>	R <sub>g</sub>	R <sub>9</sub>
RGBW36	95	93	106	84
RGBWX18	93	91	99	64

**Dominant Wavelength**

Color	RGB42/ RGBW36	RGBX18/ RGBWX18
Red	620nm	621nm
Green	525nm	519nm
Blue	467nm	465nm

**Ordering Code**

MODEL	LENGTH <sup>1</sup>	OUTPUT <sup>2</sup>	CCT	LENS	MOUNTING	FINISH <sup>3</sup>	FEED POSITION LEFT <sup>4</sup>	FEED POSITION RIGHT <sup>4</sup>	ACCESSORIES <sup>5</sup>
Bar-BABA - Bara BABA	12"-144" 2" increments	WD51SO - Standard WD51HO - High WD51VHO - Very High	18K24K 1800K - 2400K 18K27K - 1800K - 2700K 18K30K 1800K - 3000K	F - Frosted N - Narrow Beam M - Medium BW - Batwing AS - Asymmetric <sup>5</sup>	FC - Fixed Clip MAG - Magnetic <sup>6</sup>	<b>POWDER COAT</b> BK - Black <sup>7</sup> BZ - Bronze WH - White <sup>7</sup>	<b>PLENUM WIRE LEADS (72")</b> LPE - Plenum Wire End Feed LPB - Plenum Wire Back Feed LNPF - No Power Feed	<b>PLENUM WIRE LEADS (72")</b> RPE - Plenum Wire End Feed RPB - Plenum Wire Back Feed RNPF - No Power Feed	--- - N/A, leave blank BLBK - Blade louver, Black BLWB - Blade louver, White GSBK - Glare shield, Black GSWB - Glare shield, White
	12"-144" 2" increments	TW51SO - Standard TW51HO - High TW51VHO - Very High	18K30K - 1800K - 3000K 27K65K - 2700K - 6500K			<b>PREMIUM</b> MBK - Matte Black WN - Warm Nickel AB - Aged Brass PG - Polished Gold <sup>8</sup> CH - Chrome <sup>8</sup>	<b>QUICK CONNECTS (4")</b> LFE - Female Q/C, End Feed LFB - Female Q/C, Back Feed LNPF - No Power Feed	<b>QUICK CONNECTS (4")</b> RFE - Female Q/C, End Feed RFB - Female Q/C, Back Feed RNPF - No Power Feed	
	12"-144" 2" increments	RGBW36SO - Standard RGBW36HO - High RGB42SO - Standard RGB42HO - High	CLR - Color						
	12"-144" 4" increments	RGBWX18SO - Standard RGBX18SO - Standard	PXSPI - Smart Pixel Control						

1 - Custom lengths and increments are available, please consult Inside Sales with specific request.  
 2 - Warm Dim and Tunable White options can be used to comply with Title 24 JAB at max brightness depending on Lens selection, see multiplier charts to calculate specific efficacy.  
 3 - Finishes may have extended lead times. Custom RALs are available, please consult Inside Sales with specific request.  
 4 - LNPF - RNPF is not a valid configuration option.  
 5 - Louver Accessories are not compatible with Asymmetric lens.  
 6 - Magnetic mounting option is not compatible with the louvers.  
 7 - Black or White finish must be selected when ordering a louver or glare shield. See lens options on page 3.  
 8 - Polished Gold finishes and Chrome finishes have a maximum fixture length of 96"

**Powerfeeds and Connectors**

**Power Feed Position Options and Orientation**

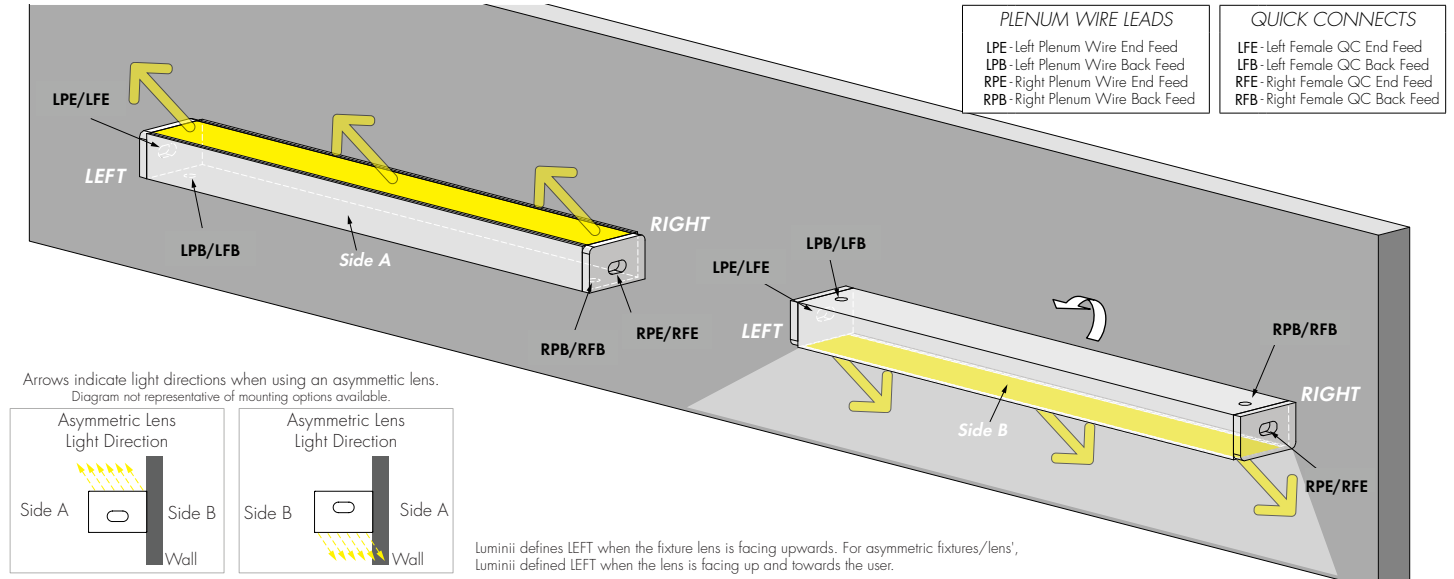

**Linking and Extension Cable Options**

**For use with Warm Dim (WD51):**

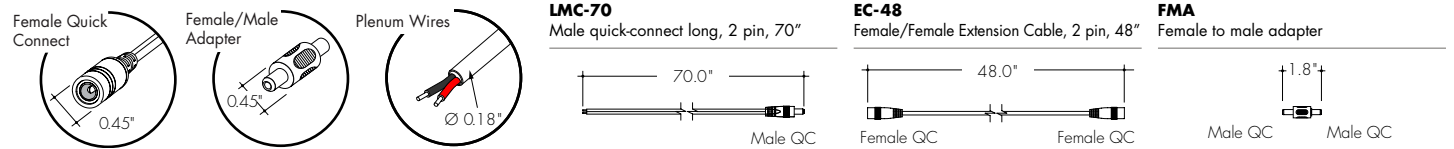

**For use with Tunable White (TW51), RGB Pixel (RGBX18) and RGBW Pixel (RGBWX18):**

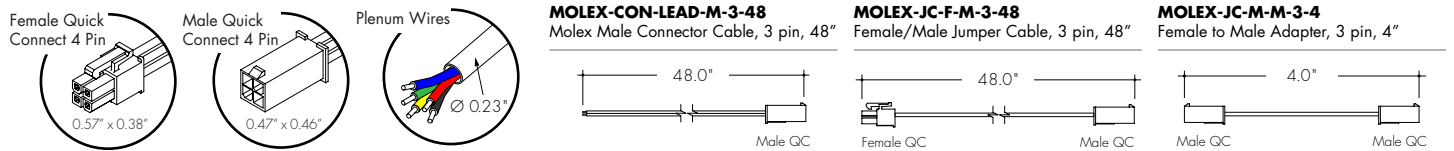

**For use with RGB (RGB42):**

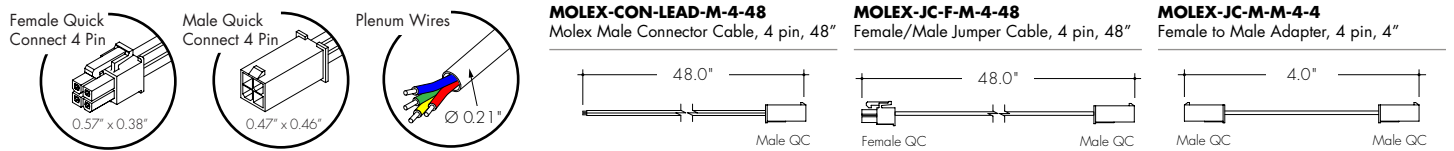

**For use with RGBW (RGBW36):**

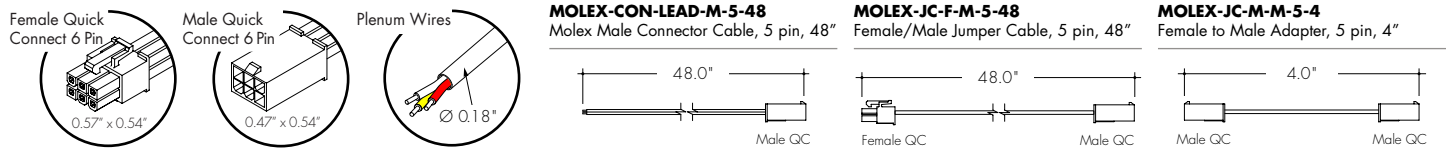

**Sample Layout**

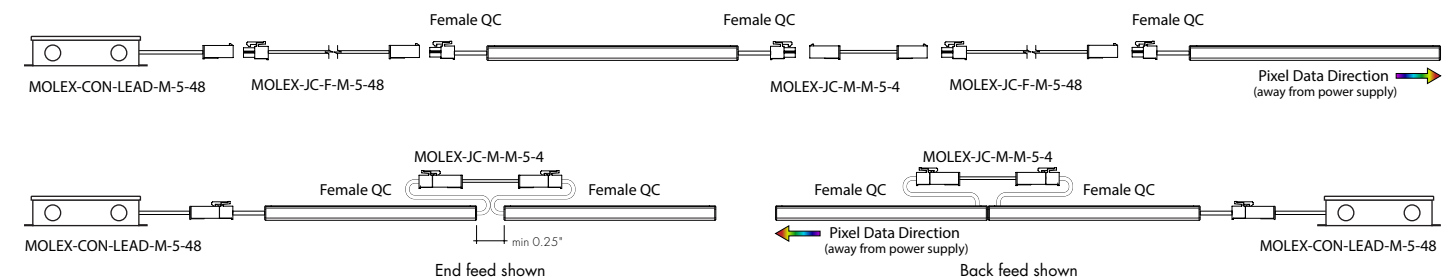

**Product Dimensions**

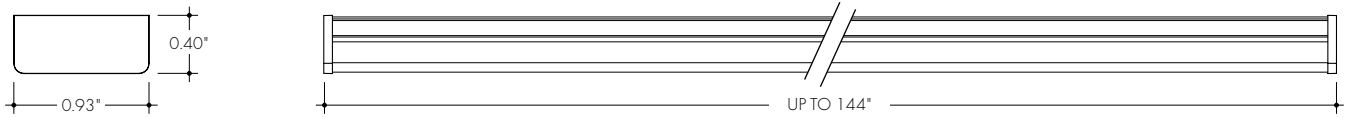

**Mounting Clip Details**

**FC**  
Fixed Clip

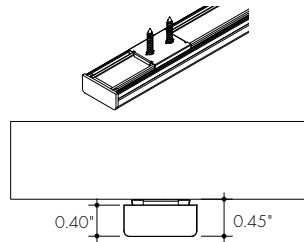

**MAG**  
Magnetic Clip

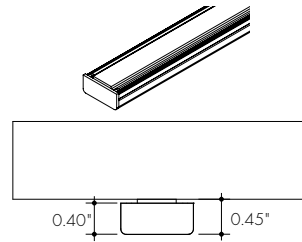

**Lens Options**

**F**  
Frosted Lens

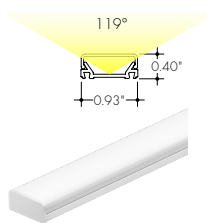

**N**  
Narrow Beam Lens

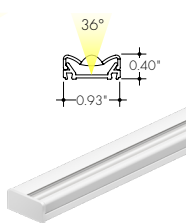

**M**  
Medium Lens

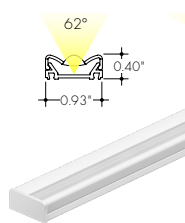

**BW**  
Batwing Lens

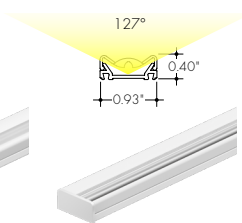

**AS**  
Asymmetric Lens

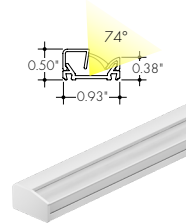

**BLXX**  
Blade Louver (frosted lens shown)

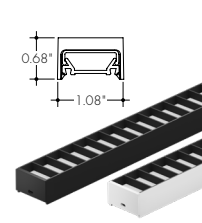

**GSXX**  
Glare Shield (frosted lens shown)

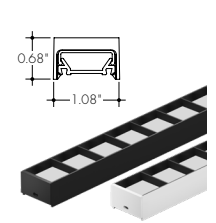

XX	Color
BK	All Black
WB	White Exterior, Black Interior

**Finish Options**

- Finish options are available in a wide variety, allowing for complete customization of style and aesthetic.
- Finishes may have extended lead times.
- Polished Gold and Chrome finishes have a maximum fixture length of 96".
- Custom RALs are available, please consult Inside Sales with specific request.
- Narrow, Medium, Batwing, and Asymmetric lens offerings will always come with a white finish on the front reflector.

**Black**  
Powder Coat

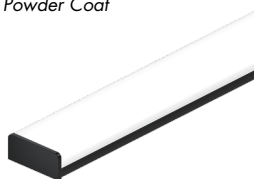

Black is a true deep black with a glossy finish.

**Bronze**  
Powder Coat

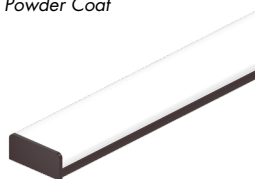

Bronze is a rich, dark brown with a satin finish.

**White**  
Powder Coat



White is a polar bright white and field paintable.

**Matte Black**  
Premium

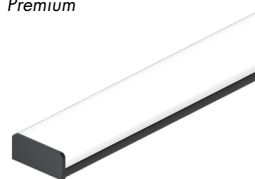

Matte Black is a dark, pitch-black with a soft flat finish.

**Warm Nickel**  
Premium

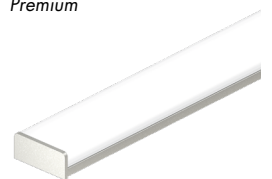

Warm Nickel is a soft, silvery smoke with warm tones and a satin finish.

**Aged Brass**  
Premium

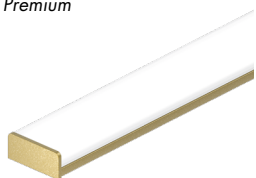

Aged Brass is a deep brown shade with slightly golden undertones.

**Polished Gold**  
Premium

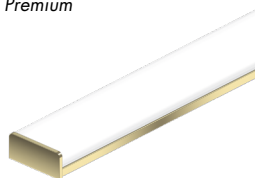

Polished Gold is bright and radiant for a brilliant finish.

**Chrome**  
Premium

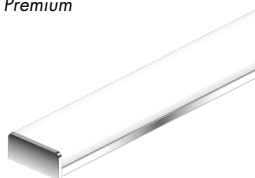

Chrome is a highly reflective silver polish.

**Black with Narrow Beam**



NOTE: Either a white finish or louver/glare shield is recommended with these lens options.

Light Transmission and Dotting

Output Options	Lens/Accessory																			
	Frosted Lens				Narrow Beam Lens				Medium Lens				Batwing Lens				Asymmetric Lens			
Dimming Level	100%	50%	10%	1%	100%	50%	10%	1%	100%	50%	10%	1%	100%	50%	10%	1%	100%	50%	10%	1%
WD51SO	ND	SD	SD	CD	CD	CD	CD	CD	CD	CD	CD	CD	CD	CD	CD	CD	CD	CD	CD	CD
WD51HO	ND	SD	SD	CD	CD	CD	CD	CD	CD	CD	CD	CD	CD	CD	CD	CD	CD	CD	CD	CD
WD51VHO	ND	SD	SD	CD	CD	CD	CD	CD	CD	CD	CD	CD	CD	CD	CD	CD	CD	CD	CD	CD
TW51SO (All On)	ND	SD	SD	CD	CD	CD	CD	CD	CD	CD	CD	CD	CD	CD	CD	CD	CD	CD	CD	CD
TW51HO (All On)	ND	SD	SD	CD	CD	CD	CD	CD	CD	CD	CD	CD	CD	CD	CD	CD	CD	CD	CD	CD
TW51VHO (All On)	ND	SD	SD	CD	CD	CD	CD	CD	CD	CD	CD	CD	CD	CD	CD	CD	CD	CD	CD	CD
TW51SO (1 CH)	ND	SD	SD	CD	CD	CD	CD	CD	CD	CD	CD	CD	CD	CD	CD	CD	CD	CD	CD	CD
TW51HO (1 CH)	ND	SD	SD	CD	CD	CD	CD	CD	CD	CD	CD	CD	CD	CD	CD	CD	CD	CD	CD	CD
TW51VHO (1 CH)	ND	SD	SD	CD	CD	CD	CD	CD	CD	CD	CD	CD	CD	CD	CD	CD	CD	CD	CD	CD
RGBW36SO	CD	CD	CD	CD	CD	CD	CD	CD	CD	CD	CD	CD	CD	CD	CD	CD	CD	CD	CD	CD
RGBW36HO	CD	CD	CD	CD	CD	CD	CD	CD	CD	CD	CD	CD	CD	CD	CD	CD	CD	CD	CD	CD
RGB42SO	CD	CD	CD	CD	CD	CD	CD	CD	CD	CD	CD	CD	CD	CD	CD	CD	CD	CD	CD	CD
RGB42HO	CD	CD	CD	CD	CD	CD	CD	CD	CD	CD	CD	CD	CD	CD	CD	CD	CD	CD	CD	CD
RGBWX18SO	CD	CD	CD	CD	CD	CD	CD	CD	CD	CD	CD	CD	CD	CD	CD	CD	CD	CD	CD	CD
RGBX18SO	CD	CD	CD	CD	CD	CD	CD	CD	CD	CD	CD	CD	CD	CD	CD	CD	CD	CD	CD	CD
<b>Transmission Percentage</b>	100%				96%				87%				114%				86%			
<b>Transmission Percentage With Blade Louver</b>	39%				53%				46%				46%				Not Compatible			
<b>Transmission Percentage With Glare Shield</b>	54%				73%				66%				64%				Not Compatible			

Use complete Dotting Chart Tool online for more dotting information

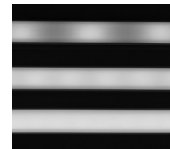

CD - Clear Dotting  
SD - Slight Dotting  
ND - No Dotting

Accessory Options

**LV-BL-BARC-24-XX**

Blade Louver reduces glare at high angle in two directions. Also available with complete fixture, use ordering code **-BLXX**

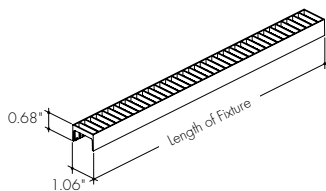

**LV-GS-BARC-24-XX**

Glare Shield reduces glare at high angle, field cuttable. Also available with complete fixture, use ordering code **-GSXX**

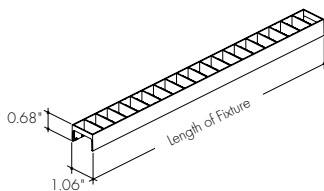

**LVSP-4T-BK**

Low Voltage, 4 Terminal Splice Box, Black, IP20

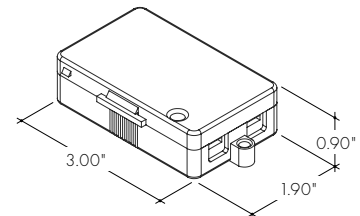

XX	Color
BK	All Black
WB	White Exterior, Black Interior

**Power Consumption**

Please visit the link/QR code below to access the Luminii Power Consumption Chart tool on our website.

There you will be able to select your fixture, output, and desired power feed to get a full power consumption table.



I'm also click-able

Desired Nominal Length: \_\_\_\_\_

Desired Output: \_\_\_\_\_

Desired CCT: \_\_\_\_\_

**Voltage Drop Calculator**

The below chart assumes nominal voltage of 24 Volts and a Voltage Drop Allowance of 3% through the wire

Wattage [W]	Maximum Wire Length From Power Supply to Start of Run [ft]						
	12 AWG	14 AWG	16 AWG	18 AWG	20 AWG	22 AWG	24 AWG
5	1088.2	684.4	430.3	270.6	170.2	107.1	67.3
10	544.1	342.2	215.1	135.3	85.1	53.5	33.7
15	362.7	228.1	143.4	90.2	56.7	35.7	22.4
20	272.0	171.1	107.6	67.7	42.6	26.8	16.8
25	217.6	136.9	86.1	54.1	34.0	21.4	13.5
30	181.4	114.1	71.7	45.1	28.4	17.8	11.2
35	155.5	97.8	61.5	38.7	24.3	15.3	9.6
40	136.0	85.5	53.8	33.8	21.3	13.4	8.4
45	120.9	76.0	47.8	30.1	18.9	11.9	7.5
50	108.8	68.4	43.0	27.1	17.0	10.7	6.7
55	98.9	62.2	39.1	24.6	15.5	9.7	6.1
60	90.7	57.0	35.9	22.6	14.2	8.9	5.6
65	83.7	52.6	33.1	20.8	13.1	8.2	5.2
70	77.7	48.9	30.7	19.3	12.2	7.6	4.8
75	72.5	45.6	28.7	18.0	11.3	7.1	4.5
80	68.0	42.8	26.9	16.9	10.6	6.7	4.2
85	64.0	40.3	25.3	15.9	10.0	6.3	4.0
90	60.5	38.0	23.9	15.0	9.5	5.9	3.7
96	56.7	35.6	22.4	14.1	8.9	5.6	3.5

## Power Supplies

See fixture and power supply instructions & spec sheet for wiring information. Dimming possible in select models - view Luminii website for list of compatible dimmers.

### For use with Warm Dim

#### Ordering Code - Universal Dimming Power Supplies 0.1% 120VAC - 277VAC

MODEL	INPUT CONTROL	WATTAGE	OUTPUT
PS-Power Supply, 120-277VAC	UNI - 0-10V Dimming (0.1%), Phase Dimming (0.1%)	30 - 30 Watts 60 - 60 Watts 96 - 96 Watts 3x96 - 3x96 Watts	24 - 24 VDC

Compatibility: View a complete list of compatible dimmers on the PS-UNI product page.

0-10V - 0.1% dimming  
MLV/ELV/TRIAC - 0.1% dimming, consult dimming compatibility chart

MODELS	PS-UNI-30W	PS-UNI-60W	PS-UNI-96W	PS-UNI-3X96W
Length	6.50"	7.40"	8.66"	11.85"
Width	3.73"	3.73"	3.73"	4.32"
Depth	1.61"	1.61"	1.61"	1.81"

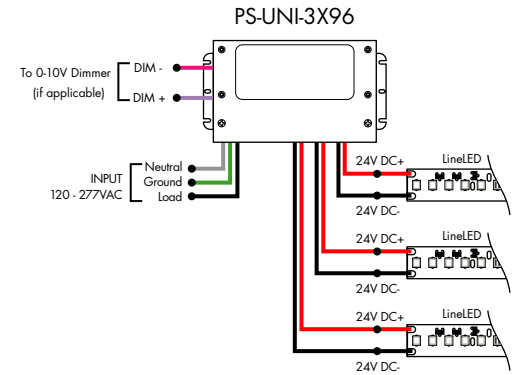
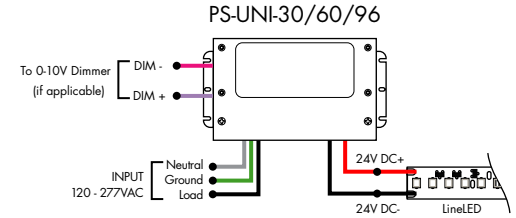

#### Ordering Code - DALI 2 Dimming Power Supplies 0.1% 120VAC - 277VAC

MODEL	INPUT CONTROL	ENVIRONMENT	WATTAGE	OUTPUT
PS-Power Supply, 120-277VAC	DALI2-DT6 - DALI2 DT6 (0.1%)	D - Dry	96-96 Watts	24 - 24 VDC

<b>Model</b>	<b>96W</b>
<b>Length</b>	14.40"
<b>Width</b>	5.20"
<b>Depth</b>	2.60"

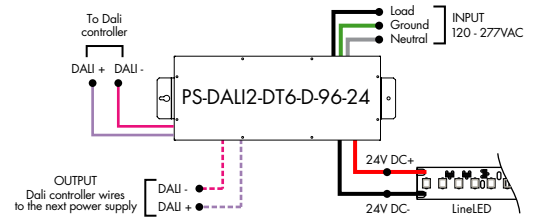

## Power Supplies

See fixture and power supply instructions & spec sheet for wiring information. Dimming possible in select models - view Luminii website for list of compatible dimmers.

### For use with Warm Dim

#### Ordering Code - 0-10V Dimming Power Supplies 0.1% 120VAC - 277VAC

MODEL	INPUT CONTROL	ENVIRONMENT	WATTAGE	OUTPUT
PS - Power Supply, 120-277VAC	010V-LIN - 0-10V Dimming (0.1%), Linear 010V-LOG - 0-10V Dimming (0.1%), Logarithmic	D - Dry	96-96 Watts 3x96-3x96 Watts	24-24 VDC

MODELS	96W	3X96
<b>Length</b>	14.40"	15.00"
<b>Width</b>	5.20"	6.62"
<b>Depth</b>	2.60"	4.45"

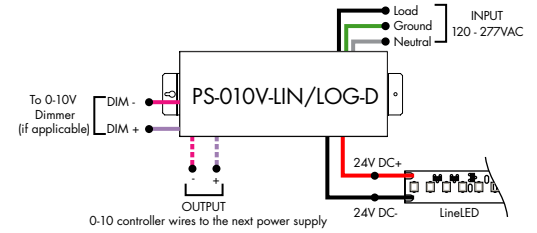

PS-010V-LIN/LOG-D-3X96

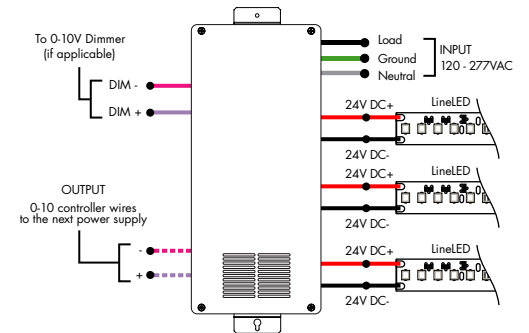

#### Ordering Code - Athena 0-10V LED Driver

MODEL	INPUT CONTROL	ENVIRONMENT	WATTAGE	OUTPUT	FEATURE
PS - Power Supply, 120-277VAC	010V-LIN - 0-10V Dimming (0.1%), Linear 010V-LOG - 0-10V Dimming (0.1%), Logarithmic	D - Dry	96-96 Watts	24-24 VDC	AWNR - Athena Wireless Node

MODELS	96W
<b>Length</b>	14.40"
<b>Width</b>	5.20"
<b>Depth</b>	2.60"

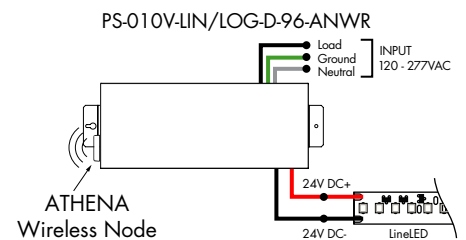

**Power Supplies**

See fixture and power supply instructions & spec sheet for wiring information. Dimming possible in select models - view Luminii website for list of compatible dimmers.

**For use with Tunable White**

**Ordering Code - DALI2 Dimming Power Supplies 0.1% 120VAC - 277VAC**

MODEL	INPUT CONTROL	ENVIRONMENT	WATTAGE	OUTPUT
PS - Power Supply, 120-277VAC	DALI2-DT8 - DALI DT8 Tunable White (0.1%)	D - Dry	96 - 96 Watts	24 - 24 VDC

MODELS	96W
Length	14.40"
Width	5.20"
Depth	2.60"

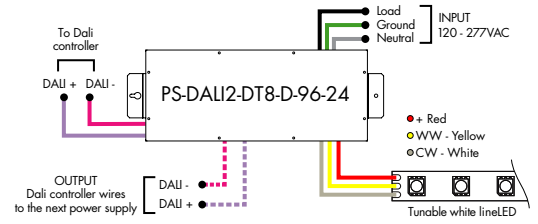

**Ordering Code - Athena DALI2 Dimming Power Supplies 0.1% 120VAC - 277VAC**

MODEL	INPUT CONTROL	ENVIRONMENT	WATTAGE	OUTPUT	FEATURE
PS - Power Supply, 120-277VAC	DALI2-DT8 - DALI DT8 Tunable White (0.1%)	D - Dry	96 - 96 Watts	24 - 24 VDC	AWN - Athena

MODELS	96W
Length	14.40"
Width	5.20"
Depth	2.60"

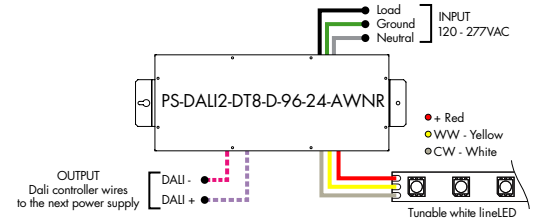

**Ordering Code - DALI2 Dimming Power Supplies 0.1% 120VAC - 277VAC - for Dim-to-Warm functionality with Tunable White Output**

MODEL	INPUT CONTROL	ENVIRONMENT	WATTAGE	OUTPUT
PS - Power Supply, 120-277VAC	DALI2-WD - DALI2 DT6 Warm Dim (0.1%)	D - Dry	96 - 96 Watts	24 - 24 VDC

MODELS	96W
Length	14.40"
Width	5.20"
Depth	2.60"

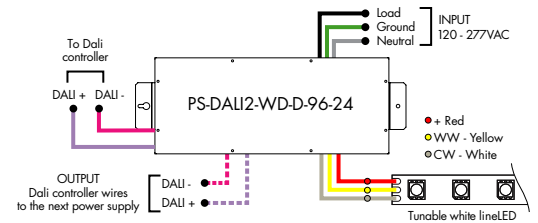

**Ordering Code - DMX Dimming Power Supplies 0.1% 120VAC - 277VAC**

MODEL	INPUT CONTROL	ENVIRONMENT	WATTAGE	OUTPUT
PS - Power Supply, 120-277VAC	DMX - DMX (0.1%)	D - Dry	96 - 96 Watts 3X96 - 3X96 Watts	24 - 24 VDC

MODELS	96W	3X96
Length	14.40"	15.00"
Width	5.20"	6.62"
Depth	2.60"	4.56"

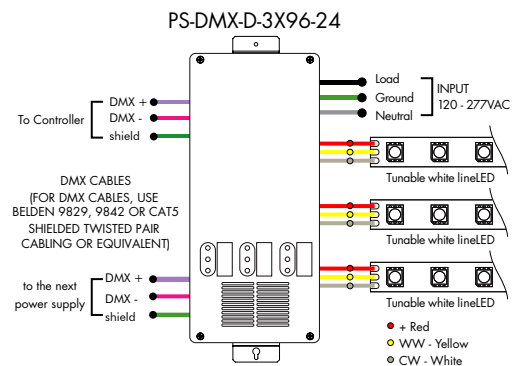
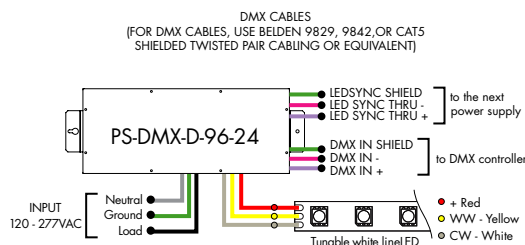

## Power Supplies

See fixture and power supply instructions & spec sheet for wiring information. Dimming possible in select models - view Luminii website for list of compatible dimmers.

### For use with Tunable White

#### Ordering Code - VintageDim® 0-10V Dimming Power Supplies 0.1% 120VAC - 277VAC

MODEL	INPUT CONTROL	ENVIRONMENT	WATTAGE	OUTPUT
PS - Power Supply, 120-277VAC	010V-WD - 0-10V Dimming (0.1%), Standard Warm Dim Curve (with Tunable White LED) 010V-TW - 0-10V Dimming (0.1%), Two Channel Control, Brightness and CCT1-CCT2 Ratio 010V-2CH - 0-10V Dimming (0.1%), Two Channel Control, LED1 Brightness and LED2 Brightness 010V-WDX - 0-10V Dimming (0.1%), Customizable Warm Dim Curve (with Tunable White LED)	D-Dry	96-96 Watts 3X96 - 3x96 Watts <sup>1</sup>	24-24 VDC

1 - 3x96 is only available with input control options 010V-WD and 010V-TW

MODELS	96W	3X96
<b>Length</b>	14.40"	15.00"
<b>Width</b>	5.20"	6.62"
<b>Depth</b>	2.60"	4.56"

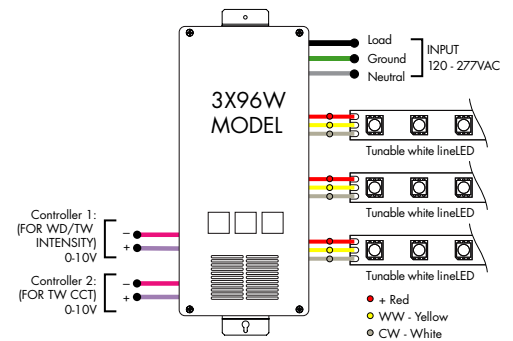
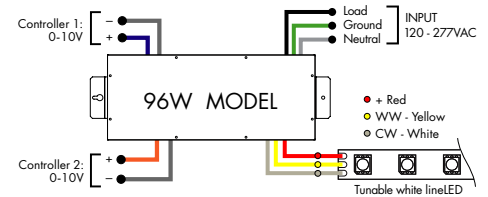

#### Ordering Code - Athena VintageDim® 0-10V Power Supply 0.1% 120VAC - 277VAC - for Dim-to-Warm functionality with Tunable White Output

MODEL	INPUT CONTROL	ENVIRONMENT	WATTAGE	OUTPUT	FEATURE
PS - Power Supply, 120-277VAC	010V-WD - 0-10V Dimming, Standard Warm Dim Curve (with Tunable White LED)	D-Dry	96-96 W	24-24 VDC	AWN - Athena

MODELS	96W
<b>Length</b>	14.40"
<b>Width</b>	5.20"
<b>Depth</b>	2.60"

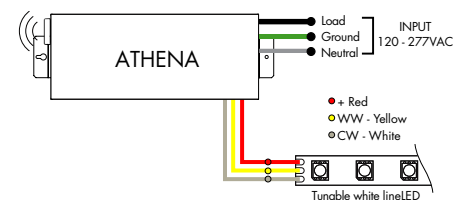

#### Ordering Code - Athena VintageDim® 0-10V Two Channel LED Driver, 0.1% 120VAC - 277VAC

MODEL	INPUT CONTROL	ENVIRONMENT	WATTAGE	OUTPUT	FEATURE
PS - Power Supply, 120-277VAC	010V-2CH - 0-10V Dimming Two Channel Control, LED1 Brightness and LED2 Brightness	D-Dry	96-96 W	24-24 VDC	AWN - Athena

MODELS	96W
<b>Length</b>	14.40"
<b>Width</b>	5.20"
<b>Depth</b>	2.60"

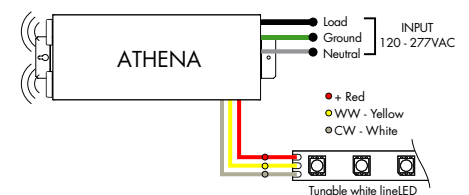

## Power Supplies

See fixture and power supply instructions & spec sheet for wiring information. Dimming possible in select models - view Luminii website for list of compatible dimmers.

### For use with RGB/RGBW

#### Ordering Code - Universal Dimming Power Supplies 0.1% 120VAC - 277VAC

MODEL	INPUT CONTROL	WATTAGE	OUTPUT
PS - Power Supply, 120-277VAC	UNI - 0-10V Dimming (0.1%), Phase Dimming (0.1%)	30 - 30 Watts 60 - 60 Watts 96 - 96 Watts 3x96 - 3x96 Watts	24 - 24 VDC

MODELS	PS-UNI-30W	PS-UNI-60W	PS-UNI-96W	PS-UNI-3X96W
<b>Length</b>	6.50"	7.40"	8.66"	11.85"
<b>Width</b>	3.73"	3.73"	3.73"	4.32"
<b>Depth</b>	1.61"	1.61"	1.61"	1.81"

REQUIRES A CONTROLLER AND A DECODER TO WORK PROPERLY

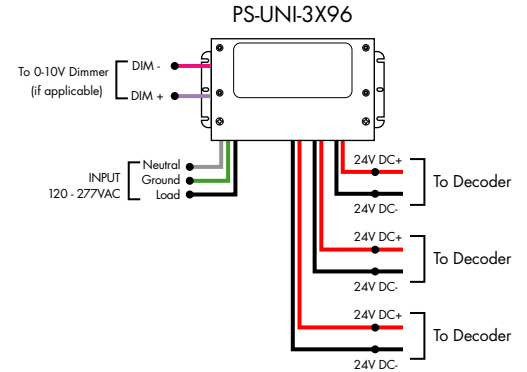
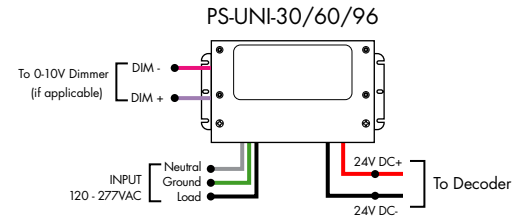

### For use with RGB/RGBW

#### Ordering Code - DMX Dimming Power Supplies 0.1% 120VAC - 277VAC

MODEL	INPUT CONTROL	ENVIRONMENT	WATTAGE	OUTPUT
PS - Power Supply, 120-277VAC	DMX - DMX (0.1%)	D - Dry	96 - 96 Watts 3X96 - 3X96 Watts	24 - 24 VDC

MODELS	96W	3X96
<b>Length</b>	14.40"	15.00"
<b>Width</b>	5.20"	6.62"
<b>Depth</b>	2.60"	4.56"

DMX CABLES (FOR DMX CABLES, USE BELDEN 9829, 9842 OR CAT5 SHIELDED TWISTED PAIR CABLING OR EQUIVALENT)

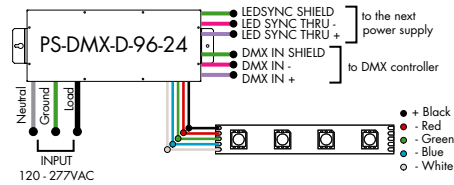

PS-DMX-D-3X96-24

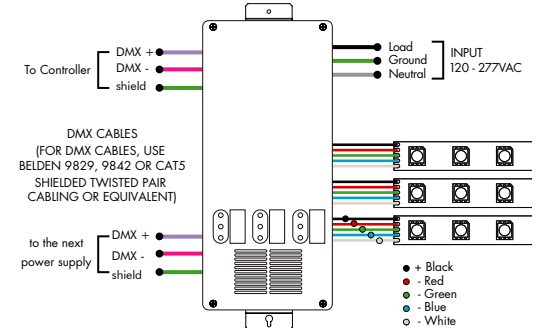

### For use with RGB/RGBW/Pixel

#### Ordering Code - Non-Dimming Power Supply 120VAC - 277VAC

MODEL	INPUT CONTROL	ENVIRONMENT	WATTAGE	OUTPUT
PS - PSV Series	ND - Non Dimming	D - Dry	96 - 96 Watts	24 - 24 VDC

MODELS	96W
<b>Length</b>	14.40"
<b>Width</b>	5.20"
<b>Depth</b>	2.60"

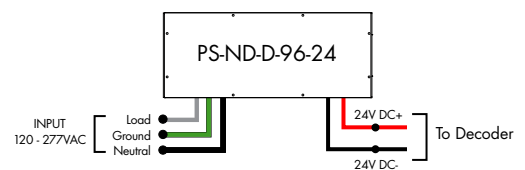

REQUIRES A CONTROLLER AND A DECODER TO WORK PROPERLY

**Controllers and Decoders**

**For use with Tunable White Power Supplies**



ORDERING CODE

MODEL

**DTW-MC**

DTW-MC - Tunable White controller

Tunable White wall-mount controller controls lighting fixtures, wireless control of TW lighting fixture. Fits in any standard US switch box. Includes all the outputs in the back of the controller.

**Features**

- Switch & dimming control function, control range > 20M.
- Smooth transition between light levels.
- Separately operate dimming and color temperature functions.
- Able to control 1 zone with endless receivers. Each receiver can maximally be controlled by 8 remotes.
- Power, temperature color and dimming functions operated by push button after receivers are connected.

**Operating Voltage**

3V DC battery

**Color Parameters**

- Brightness
- Saturation
- Fading



ORDERING CODE

MODEL

**TW-DMX**

TW-DMX - DMX controller

Tunable White DMX wall-mount controller is a fully touch sensitive controller designed in accordance with standard dimming protocol DMX512. Offers fast and accurate color temperature adjustment and brightness dimming of natural white, warm white and cold white. Designed with a touch color wheel, the DMX512 controller can adjust color temperature and brightness for all white LEDs smoothly and accurately. The DMX controller can control 1 zone with endless decoders.

**Features**

- 1 zone
- 6 color scenes
- DMX Control
- Touch Sensitive Glass Surface
- Dimming and Speed Control
- Memory Function
- Easily Fits Standard US Switch Boxes

**Operating Voltage**

12 - 24V DC

**Color Parameters**

- Brightness
- Saturation
- Primary colors
- Fading
- Color changing speed



ORDERING CODE

MODEL

**SLD-DIMTW**

SLD-DIMTW - Tunable white LED dimming module

The SLD DimTW is a constant voltage warm dimming LED dimming module. The unique dimming module accepts 0-10V control and mimics a smooth, incandescent dimming curve.

**Features**

- Flicker free 0-100% dimming
- High efficiency up to 97%
- High precision dimming ratio:>1:1000
- Fully isolated plastic housing
- Comply with EN55015 and FCC part 15 without additional input filter and capacitors
- compact size, high reliability
- 3 years warranty

**Operating Voltage**

8-48 VDC

**Controllers and Decoders**

**For use with Tunable White, RGB/RGBW Power Supplies**



Translates controller DMX512 programs for RGB and white LED strips.  
 Unique DMX address for the decoder can be set easily and displayed by the numeric display on the case. Changing and resetting the DMX address requires manual input.  
 Use power repeater to expand output.

**Operating Voltage**

12-36 VDC

**Power Capacity**

up to 96W at 24V

**Operating Temperature Range**

from -4°F to +122°F in case

ORDERING CODE

MODEL

**DDMX-RGBW**

DDMX-RGBW - DMX decoder



The RGBW receiver is easily paired with controller by the click of a button. Receiver can be reset to factory settings at any time.

Each receiver can store one static RGB color, one color sequence, and one brightness setting for the white LED strip. Receivers assigned to the same scene within the same zone will have the same LED static color and color sequence.

**Operating Voltage**

12-36 VDC

**Power Capacity**

up to 96W at 24V

**Operating Temperature Range**

from -4°F to +122°F in case

ORDERING CODE

MODEL

**RGBW-RC-R**

RGBW-RC-R - RGBW receiver



Extends identical signal when connected in series to an RGBW LED control system. The RGBW signal repeater works with Luminii RGB and RGBW controllers, receivers, and decoders.

RGBW signal can be extended indefinitely when adequate power supply (not included) is connected to the system.

**Operating Voltage**

12-36 VDC

**Power Capacity**

up to 96W at 24V

**Operating Temperature Range**

from -4°F to +122°F in case

ORDERING CODE

MODEL

**RGBW-SR**

RGBW-SR - RGBW signal repeater

**Controllers and Decoders**

**For use with RGB/RGBW Power Supplies**



ORDERING CODE

MODEL

**RGBW-MC3**

RGBW-MC3 - 4-zone RGBW controller

Easy to operate wireless interface suitable for static or color changing scenes. Control 4 different color zones separately or at the same time. RGBW receiver (RGBW-RC-R) required for operation. Assign multiple receivers per zone to cover a large area.

Color wheel enables highly stable and sensitive color control functionality. Create your own color changing sequences with ease and flexibility.

**Power**

qty 3 AAA batteries

**Scenes**

up to 4 unique zones

**Signal**

Wireless (RF)

**Energy Saving**

Deactivates after 10 seconds of inactivity

**Color Parameters**

- Brightness
- Saturation
- Primary colors
- Speed of color changing sequence
- Fading

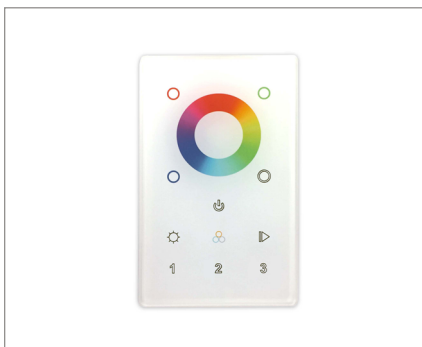

ORDERING CODE

MODEL

ZONES

COLOR

--	--	--

DMX-DMX Controller    3Z-Three Zone    1Z-One Zone    RGBW-Red,Green,Blue,& White

DMX /Wireless RGB-W wall-mount controller controls DMX lighting fixtures, wireless control of RGB-W lighting fixture or use both simultaneously. Fits in any standard US switch box. Includes all the outputs in the back of the controller.

Control brightness levels with a single touch, personalize and memorize 3 different scenes, and even create 3 variations of white.

**Features**

- 2 in 1 in-Wall Controller: DMX Control or Wireless RGB-W
- 65,000 Color Options, Dimming and Speed Control
- Memory Function
- 50 Foot Wireless Range
- Easily Fits Standard US Switch Boxes
- Touch Sensitive Glass Surface
- Includes 10 Built in Programs, or Create and Play Your Own

**Operating Voltage**

12 - 24V DC

**Color Parameters**

- Brightness
- Saturation
- Primary colors
- Fading
- Color changing speed

**For use with Tunable White, RGB/RGBW, Pixel Power Supplies**

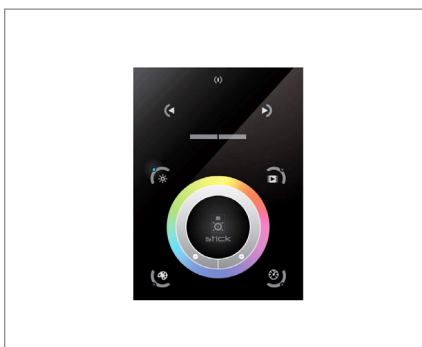

ORDERING CODE

MODEL

**TSDMX-E**

TSDMX-E - Touchscreen DMX controller

Programmable advanced DMX512 lighting controller featuring a touch-screen interface. Operates as stand alone controller or integrated with most architectural lighting control systems. Can controller endless DMX512 enabled devices.

Mounts to standard single or dual gang wall box with the included power supply inside the junction box. Terminal block design for power and data connections.

**Features**

- Sleek glass design which sits 0.43" from the wall
- Graphical color display to show selected environment
- Color/dimmer/speed palette
- Color temperature mixing
- Touch sensitive buttons. No mechanical parts
- Touch sensitive wheel allows for accurate color selection
- Multi-zone microSD memory
- Multi-room control with 500 scenes, 10 zones
- 1024 DMX channels. Control 340 RGB fixtures
- USB & Ethernet connectivity for programming and control

**Power Supply**

7 VDC (included)

**Programmability**

PC, Mac, Tablet, Smartphone

**Output Signal**

DMX512 (1024 channels)

**Color Parameters**

- Brightness
- Saturation
- Speed of color changing sequence
- Fading / dimming / brightness

**Controllers and Decoders**

**For use with Tunable White, RGB/RGBW Power Supplies**

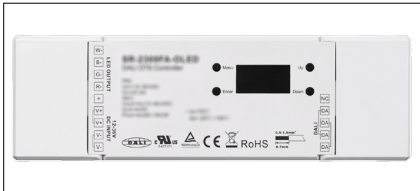

ORDERING CODE

MODEL

**DALI2-DT8-RGBW**

DALI2-DT8-RGBW - DALI-2 RGBW Decoder

A 4-channel DALI2 DT8 decoder designed to control RGB, RGBW, and TW LED fixtures, featuring adjustable color temperature and customizable lumen output.

**Voltage/Frequency**  
12-36VDC

**Max Output Power**  
4 output channels, 60-180W each

**Max Output Current**  
4 output channels, max of 5A each

**Ambient Operating Temperature Range**  
-20 to 50°C

**Environment**  
Dry (IP20)



ORDERING CODE

MODEL

**DDMX-5CH-RDM-PRO**

DDMX-5CH-RDM-PRO - DMX512 Decoder

DMX512 decoder with RDM functionality features 5 PWM output channels with common anode. High PWM output frequency range allows the product to be used in HD video conferencing spaces. All DMX products to be installed per DMX512 Standard.

**Power**

96 Watt

**Inputs**

RJ45, XLR-5Pin, Terminal Block

**DMX Channels**

1 to 5 settable

**PWM Output Resolution Ratio**

8 or 16 bit

**PWM Output Frequency**

500Hz - 30KHz

**Output Dimming Curve Gamma Value**

0.1 ~ 9.9



ORDERING CODE

MODEL

**RGBW-WI-R**

RGBW-WI-R - WIFI generator

RGBW-WI-R creates a local network that enables any electronic device (phone, tablet, etc.) to control the RGB/W strip connected to a RGBW-RC-R receiver.

The control functions are achieved through a free application download for Android and iOS devices called REALCOLOR.

**Operating Voltage**

12-36 VDC

**Power Supply**

PI-130-24 (included)

**Operating Temperature Range**

from -4°F to +122°F in case

**For use with Pixel Power Supplies**

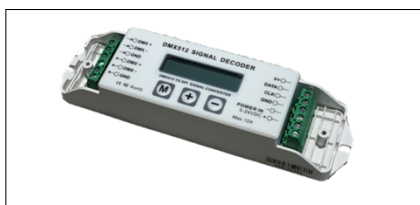

ORDERING CODE

MODEL

**SR-DMX-SPI**

SR-DMX-SPI - Smart Pixel Decoder

The SR-DMX-SPI is a smart LED pixel decoder that controls RGB/RGBW pixel LED strips with SPI signal. Designed with an OLED backlit panel, the pixel controller allows for easy configuration of most settings. Four push buttons are available for control of the LED functions.

\*For pixel only.

**Features**

- 2 in 1 in-Wall Controller: DMX Control or Wireless RGB-W
- SPI signal output for RGB/RGBW pixel light control
- DMX512 controllable and RF/WIFI remote controllable
- Capable of addressing up to 1020 RGB pixels & 765 RGBW pixels
- OLED panel allows for easy configuration

**Operating Voltage**

12 - 36V DC

**Power capacity**

up to 96W at 24V

**Operating temperature range**

from -4°F to +122°F in case