



Helen

A modern take on the classic design of the Candelabra. Designed to be flush to the wall to avoid damage common in high-traffic corridors. Featuring a robust and vandal resistant resin shade material that can be easily cleaned and is virtually indestructible. High-performance LED module providing evenly illuminated, optically correct, energy-efficient lighting. IK10 UL Certified, ADA compliant, and Title24 JA8 Optional.



CO7W7H Sconce, Candelabra with Satin Nickel Finish



MODULE	Field Replaceable C10W LED module
RATED LIFETIME	L70 100,000 hrs
SHADE	Vandal resistant. IK10 UL Certified. Protected against 20 joules of impact.
CERTIFICATIONS	UL Damp Listed, IK10 UL Certified, Title24 Optional JA8
WARRANTY	5 Years
WATTAGE	Single Candelabra: 10W Double Candelabra: 20W
CRI	90+
DIMMING	Triac/ELV
WEIGHT	Single Candelabra: 5 lbs Double Candelabra: 10 lbs
PROJECTION	4"

MODULE	WATTS	CCT	DELIVERED LUMENS: RESIN SHADE	DELIVERED LUMENS: WHITE OPAL ACRYLIC	INPUT
AU-C10W	10W	2700	586	733	120V, 277V
	10W	3000	636	795	120V, 277V
	10W	3500	636	795	120V, 277V
	10W	4000	696	870	120V, 277V

Note: For Gold Shimmer, Linear Cross, and Cayenne resin, multiply delivered lumens by .8

Helen Candelabra

alva

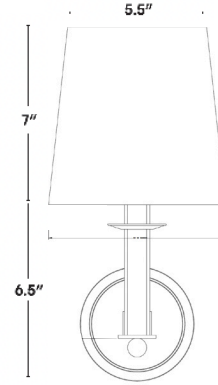
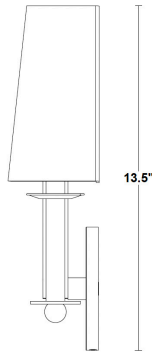
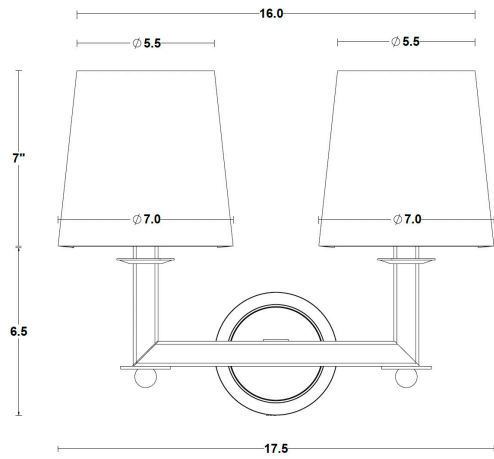
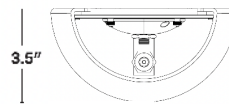
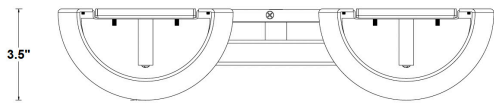

4 7/8"
WALL CANOPY

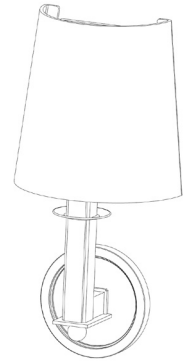

Architectural Resin



AUTUMN, **A**

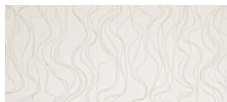

BURANO (VERT), **BV**



RAIN (VERT), **RV**



GOLD SHIMMER (VERT), **GSV**

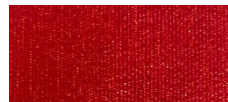

CAYENNE (VERT), **CVV**



LINEAR CROSS (VERT), **LCV**



ISLAND BREEZE, **IB**

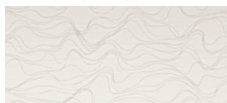

BURANO (HOR), **BH**



RAIN (HOR), **RH**



GOLD SHIMMER (HOR), **GSH**



CAYENNE (HOR), **CYH**



LINEAR CROSS (HOR), **LCH**



FAUX ALABASTER, **FA**



WHITE OPAL ACRYLIC, **WO**

Metal Powder Coat Finishes



ENVIRO SATIN NICKEL, **ESN**



ENVIRO SATIN BRASS, **ESB**



DARK BRONZE (DB)



Enviro Satin Nickel (ESN)



Enviro Satin Brass (ESB)



Dark Bronze (DB)

