



Zoom - Static White

Linear Illumination System



Features

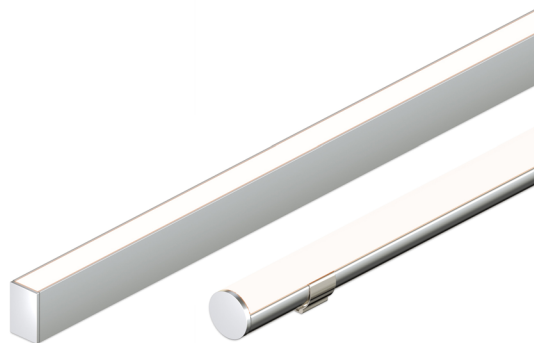

Zoom Zoom Round

- 24VDC Class 2 fixtures
- Up to 116" with Clear and Frosted Lens, and up to 144" with Round Frosted Lens. Fixtures can be linked up to 39' depending on output
- Suitable for undercabinet, millwork recessed, and surface mount applications
- Approved for closet/storage space installation per NEC 410.16(A) (3) and 410.16(C)(5)
- Class 2 listed for damp locations
- Proprietary strong bond solder method handles up to 50 lbs of pull force on wire leads and connectors
- 5 Year warranty

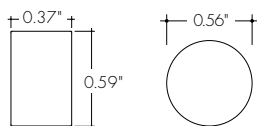

Zoom Zoom Round

Finish Options (see page 2 for additional information)

- Silver Anodized
- Black
- Bronze
- White
- Matte Black
- Warm Nickel
- Aged Brass
- Polished Gold
- Chrome

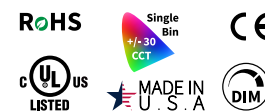

Technical Information

MODEL	High Color Quality
OUTPUT OPTIONS	5MM36SO
Lumens Output (3000K) (with a Clear Lens)	128 lm/ft
Average Power Consumption (for a 4' section)	3.2 W/ft
Efficacy	40 lm/W
Max Run Length (in series)	39 ft
Max Ambient Temperature*	40°C [104°F]

*Max Ambient Temperature to maintain L70 of 50k+ hours. Exceeding Max Ambient Temperature may result in decreased life/output. Consult Technical Support for specific inquiries.

CCT	Multiplier (reference - 3000K)	High Color Quality (5MM36)		
		CRI	R _f	R _g
2200K	0.70	96	95	101
2400K	0.72	98	97	101
2700K	0.74	97	96	101
3000K	1.00	97	95	104
3500K	1.02	97	94	105
4100K	1.07	97	90	99

Ordering Code

MODEL	LENGTH ¹	OUTPUT	CCT	LENS ²	MOUNTING	FINISH ³	POSITION	POWER FEED
ZO-Zoom	12" - 144" 2" increments	5MM36SO-Standard	22K-2200K 24K-2400K 27K-2700K 29K-2900K 30K-3000K 35K-3500K 41K-4100K	C-Clear F-Flat Frosted RF-Round Frosted	FC-Fixed Clip	SA-Silver Anodized BK-Black BZ-Bronze WH-White MBK-Matte Black WN-Warm Nickel AB-Aged Brass PG-Polished Gold ⁴ CH-Chrome ⁴	E-End B-Back	1 - 72" wire leads 1X2 72" wire leads at both ends 2 - 72" wire leads at one end and Quick Connect at other 3 - Single Quick Connect 4 - Dual Quick Connect

1 - Custom lengths and increments are available, please consult Inside Sales with specific request.
2 - Flat Clear and Frosted lens options are only available up to 116".

3 - Non SA finishes may have extended lead times. Custom RALs are available, please consult Inside Sales with specific request.
4 - Polished Gold finishes has a maximum fixture length of 48", and Chrome finishes has a maximum fixture length of 72".

Product Dimensions

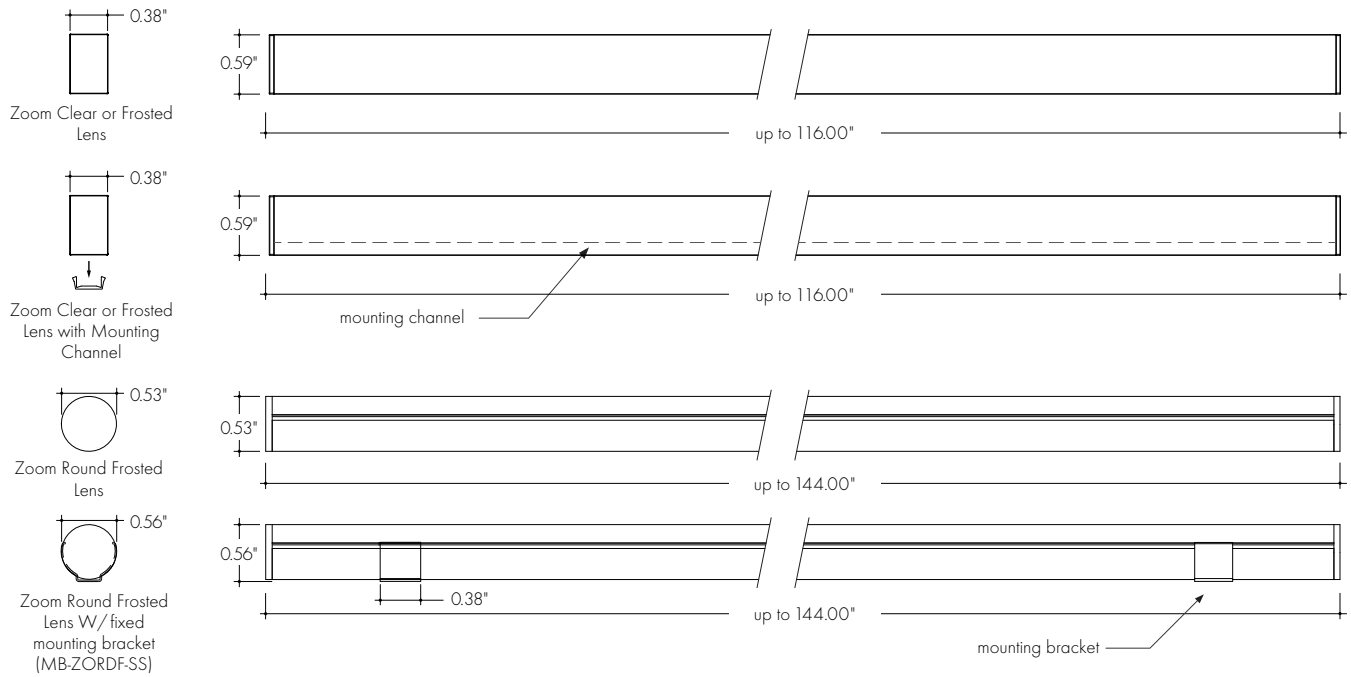

Finish Options

- Finish options are available in a wide variety, allowing for complete customization of style and aesthetic.
- Non Silver Anodized finishes may have extended lead times.
- Polished Gold finishes has a maximum fixture length of 48", and Chrome finishes has a maximum fixture length of 72".
- Custom RALs are available, please consult Inside Sales with specific request.

Silver Anodized

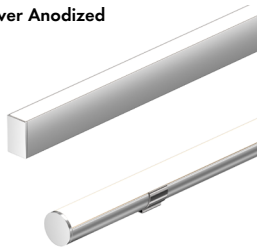

Silver Anodized is a soft silver with a clear finish.

Black

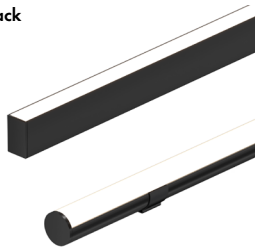

Black is a true deep black with a glossy finish.

Bronze

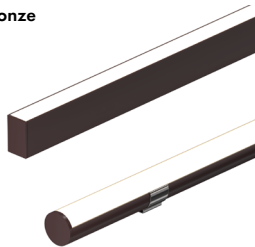

Bronze is a rich, dark brown with a satin finish.

White

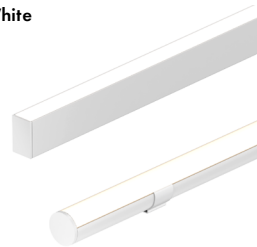

White is a polar bright white and field paintable.

Matte Black

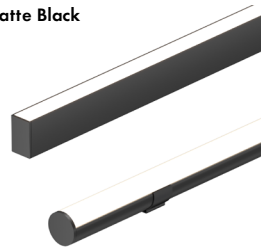

Matte Black is a dark, pitch-black with a soft flat finish.

Warm Nickel

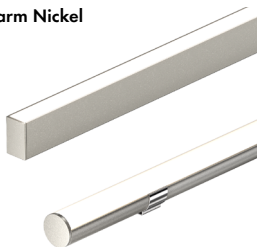

Warm Nickel is a soft, silvery smoke with warm tones and a satin finish.

Aged Brass

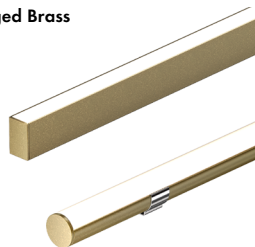

Aged Brass is a deep brown shade with slightly golden undertones.

Polished Gold

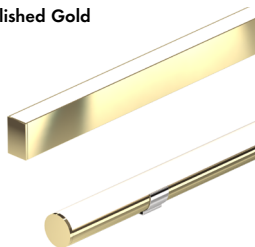

Polished Gold is bright and radiant for a brilliant finish.

Chrome



Chrome is a highly reflective silver polish.

Powerfeeds and Connectors

Linking and Extension Cable Options

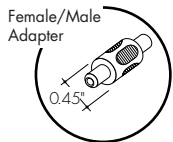
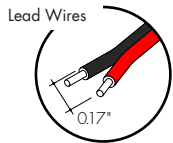
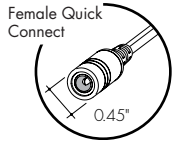
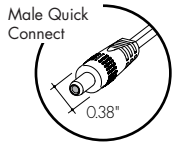

LMC-12
Male quick-connect, 2 pin, 12"

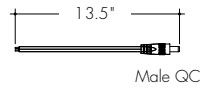

LMC-70
Male quick-connect long, 2 pin, 70"

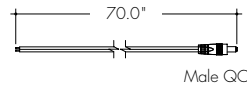

EC-12
Female to Female Extension Cable, 2 pin, 12"

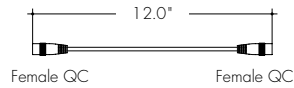

EC-48
Female to Female Extension Cable, 2 pin, 48"

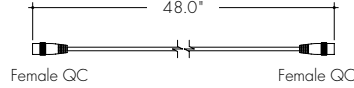

EC-120
Female to Female Extension Cable, 2 pin, 120"

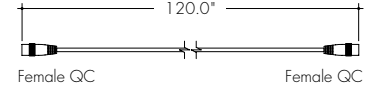

LYC
1 Female to 2 Male Splitter Cable, 2 pin, 12"

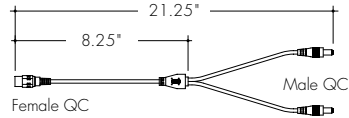

FMA
Female to male adapter

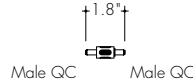

IS-DC
Male to Female Inline DC Switch, 2 pin, 12"

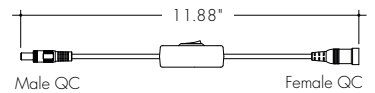

Powerfeeds Position/Type

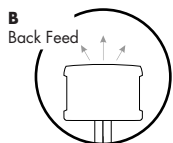
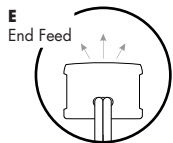

1
72" wire leads



1X2
72" wire leads at both ends



2
72" wire leads at one end and Female Quick Connect at other

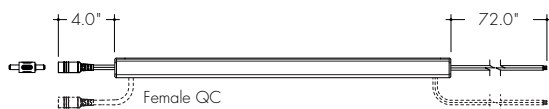

3
Single Female Quick Connect

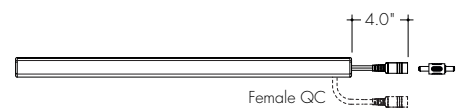

4
Dual Female Quick Connect



Side and Back feeds shown as dashed lines
All wires are 18 AWG unless otherwise specified
-2, -3, -4 include FMA as shown

Sample Layout

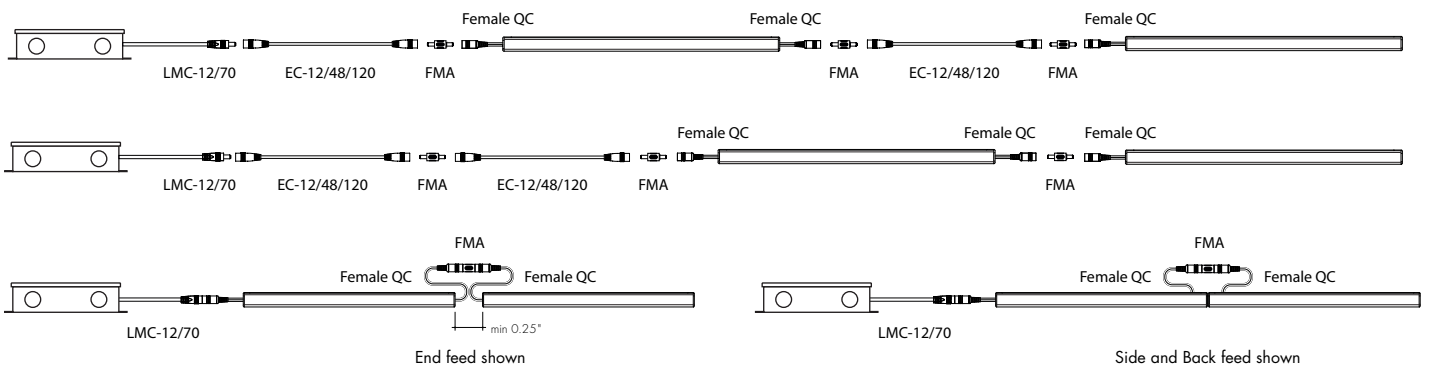

Light Transmission and Dotting

Output Options	Lens/Accessory		
	Round Frosted Lens	Clear Lens	Frosted Lens
5MM36SO	ND	CD	ND
Transmission Percentage	104%	100%	63%

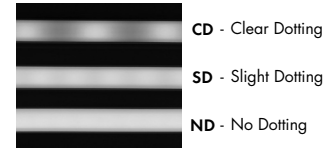

Accessory Options

LVSP-4T-BK
Low Voltage, 4 Terminal Splice Box, Black

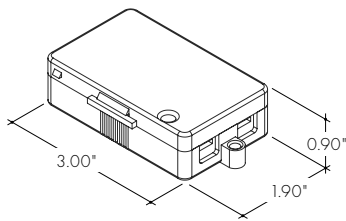

OS-DC-F4-BK
Occupancy Sensor

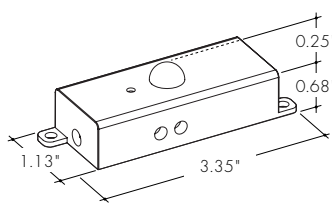

Male Quick Connect, FMA, LMC, LYC, or IS-DC are required for input and output.

DIM-DC-F4-BK
24VDC Low Voltage In-line Dimmer Module

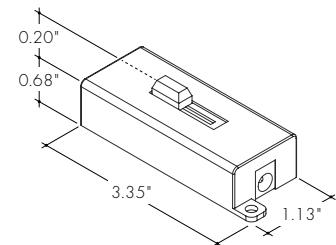

Male Quick Connect, FMA, LMC, LYC, or IS-DC are required for input and output.

Photometry

ZO-48-5MM36SO-30K-C
Zoom, 4ft, SO, 3000K, Clear Lens

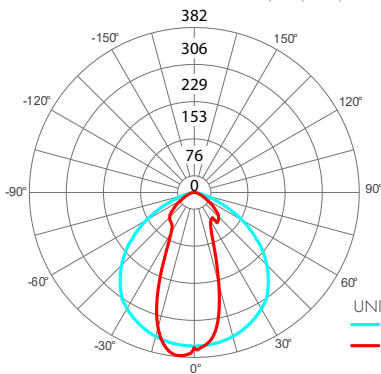

Zonal Lumen Summary 3000K

Zone	Lumen	% Fixture
0-30	178	34.8%
0-40	271	53.1%
0-60	445	87.1%
0-90	509	99.6%
0-180	511	100%

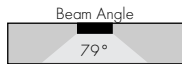

ZO-48-5MM36SO-30K-F
Zoom, 4ft, SO, 3000K, Frosted Lens

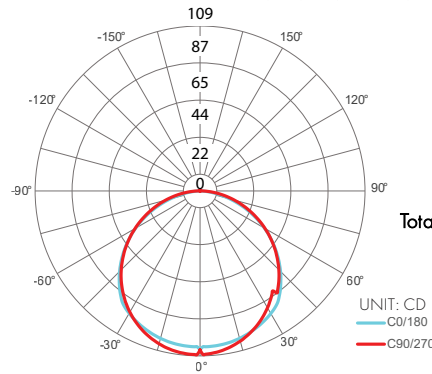

Zonal Lumen Summary 3000K

Zone	Lumen	% Fixture
0-30	85	26.5%
0-40	141	43.9%
0-60	252	78.3%
0-90	321	99.8%
0-180	322	100%

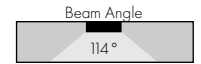

ZO-48-5MM36SO-30K-RF
Zoom, 4ft, SO, 3000K, Round Frosted Lens

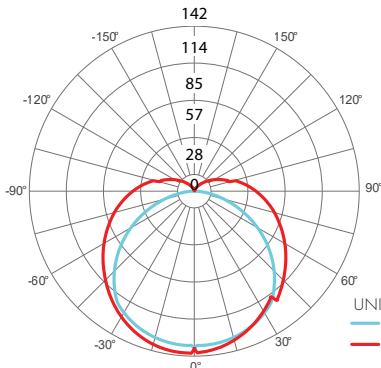

Zonal Lumen Summary 3000K

Zone	Lumen	% Fixture
0-30	118	19.9%
0-40	196	33.3%
0-60	364	61.7%
0-90	526	89.2%
0-180	590	100%

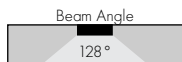

Power Consumption

Tested at Full Power with PDC Series power supplies.

*For Back Feed add 4/16" (1/4") to Actual Length. Standard Nominal Lengths offered provide minimal shadowing. For alternate lengths, please consult Inside Sales with specific request.

High Color Quality (5mm36)

Nominal Length (in)	End Feed Actual Length*	Watts		Nominal Length (in)	End Feed Actual Length*	Watts		Nominal Length (in)	End Feed Actual Length*	Watts	
		SO				SO				SO	
12	10 7/16	2.6	47	—	—	82	81 5/16	18.0	117	116 12/16	26.1
13	12 7/16	2.6	48	47 13/16	12.5	83	—	—	118	—	—
14	—	—	49	—	—	84	83 4/16	18.5	119	118 11/16	26.6
15	14 6/16	3.1	50	49 13/16	12.9	85	—	—	120	—	—
16	—	—	51	—	—	86	85 4/16	18.9	121	120 11/16	27.1
17	16 6/16	3.6	52	51 12/16	12.9	87	—	—	122	—	—
18	—	—	53	—	—	88	87 3/16	19.4	123	122 10/16	27.6
19	18 5/16	4.2	54	53 12/16	12.9	89	—	—	124	—	—
20	—	—	55	—	—	90	89 3/16	19.9	125	124 10/16	28.1
21	20 4/16	4.7	56	55 11/16	12.9	91	—	—	126	—	—
22	—	—	57	—	—	92	91 2/16	20.4	127	126 9/16	28.6
23	22 4/16	5.2	58	57 11/16	12.9	93	—	—	128	—	—
24	—	—	59	—	—	94	93 2/16	20.9	129	128 9/16	29.0
25	24 3/16	5.7	60	59 10/16	12.9	95	—	—	130	—	—
26	—	—	61	—	—	96	95 1/16	21.1	131	130 8/16	29.5
27	26 3/16	6.2	62	61 10/16	13.1	97	—	—	132	—	—
28	—	—	63	—	—	98	97 1/16	21.6	133	132 8/16	30.0
29	28 2/16	6.6	64	63 9/16	13.6	99	—	—	134	—	—
30	—	—	65	—	—	100	99	22.0	135	134 7/16	30.5
31	30 2/16	7.1	66	65 9/16	14.1	101	101	22.5	136	—	—
32	—	—	67	—	—	102	—	—	137	136 7/16	30.9
33	32 1/16	7.3	68	67 8/16	14.6	103	102 15/16	22.9	138	—	—
34	—	—	69	—	—	104	—	—	139	138 6/16	31.4
35	34 1/16	7.7	70	69 8/16	15.1	105	104 15/16	23.3	140	—	—
36	—	—	71	—	—	106	—	—	141	140 6/16	31.9
37	36	8.2	72	71 7/16	15.6	107	106 14/16	23.8	142	—	—
38	38	8.8	73	—	—	108	—	—	143	142 5/16	32.3
39	—	—	74	73 7/16	16.0	109	108 14/16	24.2	144	—	—
40	39 15/16	9.5	75	—	—	110	—	—			
41	—	—	76	75 6/16	16.5	111	110 13/16	24.7			
42	41 15/16	10.3	77	—	—	112	—	—			
43	—	—	78	77 6/16	17.0	113	112 13/16	25.2			
44	43 14/16	11.0	79	—	—	114	—	—			
45	—	—	80	79 5/16	17.5	115	114 12/16	25.7			
46	45 14/16	11.8	81	—	—	116	—	—			

Voltage Drop Calculator

The below chart assumes nominal voltage of 24 Volts and a Voltage Drop Allowance of 3% through the wire

Wattage [W]	Maximum Wire Length From Power Supply to Start of Run [ft]						
	12 AWG	14 AWG	16 AWG	18 AWG	20 AWG	22 AWG	24 AWG
5	1088.2	684.4	430.3	270.6	170.2	107.1	67.3
10	544.1	342.2	215.1	135.3	85.1	53.5	33.7
15	362.7	228.1	143.4	90.2	56.7	35.7	22.4
20	272.0	171.1	107.6	67.7	42.6	26.8	16.8
25	217.6	136.9	86.1	54.1	34.0	21.4	13.5
30	181.4	114.1	71.7	45.1	28.4	17.8	11.2
35	155.5	97.8	61.5	38.7	24.3	15.3	9.6
40	136.0	85.5	53.8	33.8	21.3	13.4	8.4
45	120.9	76.0	47.8	30.1	18.9	11.9	7.5
50	108.8	68.4	43.0	27.1	17.0	10.7	6.7
55	98.9	62.2	39.1	24.6	15.5	9.7	6.1
60	90.7	57.0	35.9	22.6	14.2	8.9	5.6
65	83.7	52.6	33.1	20.8	13.1	8.2	5.2
70	77.7	48.9	30.7	19.3	12.2	7.6	4.8
75	72.5	45.6	28.7	18.0	11.3	7.1	4.5
80	68.0	42.8	26.9	16.9	10.6	6.7	4.2
85	64.0	40.3	25.3	15.9	10.0	6.3	4.0
90	60.5	38.0	23.9	15.0	9.5	5.9	3.7
96	56.7	35.6	22.4	14.1	8.9	5.6	3.5

Power Supplies

See Power Supply instructions and spec sheet for wiring information. For a complete list of compatible dimmers, see Compatible Dimming Chart on the Resources page.

Universal Power Supply 1% 120VAC - 277VAC

MODEL	POWER	OUTPUT
PDCU-D - IP20 Dry Series	30 - 30 W 60 - 60 W 96 - 96 W 3X96 - 3X96 W	24 - 24 VDC
PDCU-W - IP66 Wet Series	96 - 96 W 3X96 - 3X96 W	

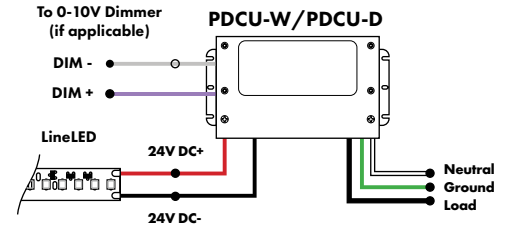

0-10V dims down to 1%, MLV/ELV/TRIAC dims down to 1%.
For a complete list of compatible dimmers, see [Compatible Dimming Chart](#) on the Resources page.

MODELS	PDCU-W 96W	PDCU-W 3X96W	PDCU-D 30W	PDCU-D 60W	PDCU-D 96W	PDCU-D 3X96W
Length	8.66"	11.85"	6.10"	7.93"	8.25"	9.57"
Width	3.73"	4.32"	3.35"	3.35"	4.10"	5.94"
Depth	1.61"	1.81"	1.33"	1.32"	1.56"	1.13"

0-10V Dimming Power Supplies 0.1% 120VAC - 277VAC

MODEL	POWER	OUTPUT	DIMMING
PS010V - 0-10V Power Supply dims down to 0.1%	96 - 96 Watt 3X96 - 3 X 96 Watt	24 - 24 VDC	LIN - Linear LOG - Logarithmic

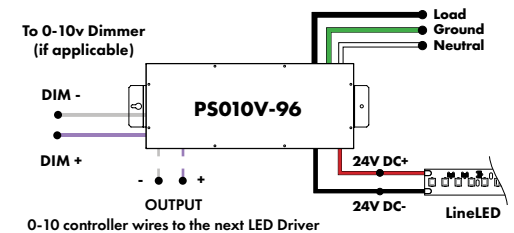

MODELS	96W	3X96
Length	14.40"	15.75"
Width	5.20"	6.62"
Depth	2.60"	4.95"

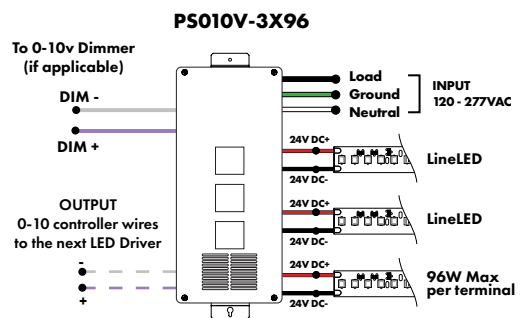

Triac, MLV, & ELV Compatible Dimmers

MODEL	POWER	OUTPUT
PDC - (IP20) Power Supply	96 - 96 Watts	24 - 24 VDC

MODELS	96W
Length	8.25"
Width	4.10"
Depth	1.56"

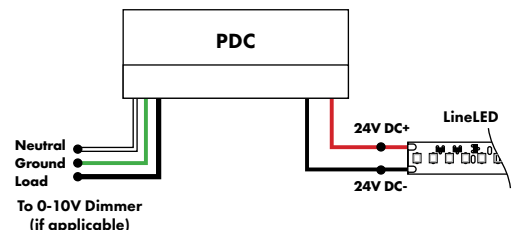

Power Supplies

See Power Supply instructions and spec sheet for wiring information. For a complete list of compatible dimmers, see Compatible Dimming Chart on the Resources page.

DMX Dimming Power Supplies 120VAC - 277VAC

MODEL	POWER	OUTPUT
PSDMX - DMX Power Supply dims down to 0%	96 - 96 Watt 3X96 - 3 X 96 Watt	24 - 24 VDC

Features eldoLED's LINEARdrive configurable dimmable drivers

MODELS	96W	3X96
Length	14.40"	15.75"
Width	5.20"	6.62"
Depth	2.60"	4.95"

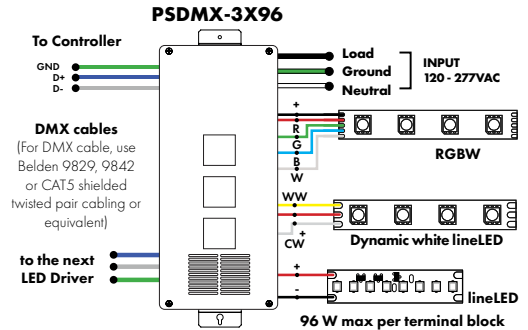
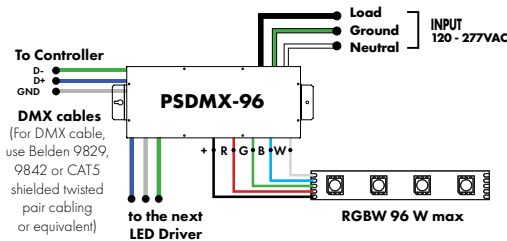

DALI 0% Dimming Power Supplies 120VAC - 277VAC

MODEL	POWER	OUTPUT
PSDALI - DALI Power Supply dims down to 0%	96 - 96 Watt 3X96 - 3 X 96 Watt	24 - 24 VDC

Features eldoLED's LINEARdrive configurable dimmable drivers

Model	96W	3X96
Length	14.40"	15.75"
Width	5.20"	6.62"
Depth	2.60"	4.95"

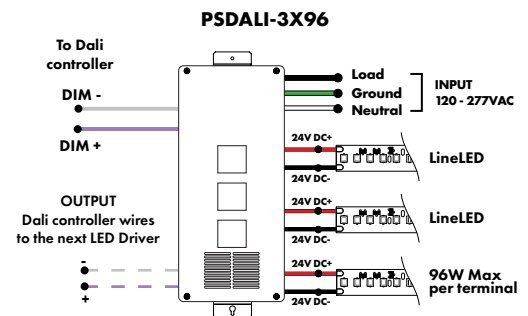
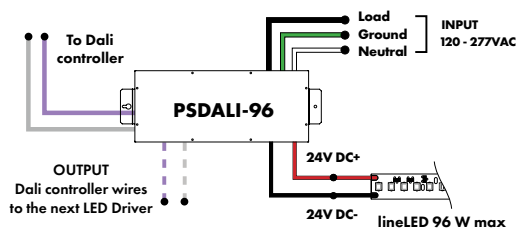

Enlighted Enabled Dimming Power Supplies 120VAC - 277VAC

MODEL	POWER	OUTPUT	DIMMING	LOCATION
PSV - PSV Series	96 - 96 Watt	24 - 24 VDC	ENL - Enlighted Dimming dims down to 0%	D - Damp

Model	96W
Length	14.40"
Width	5.20"
Depth	2.60"

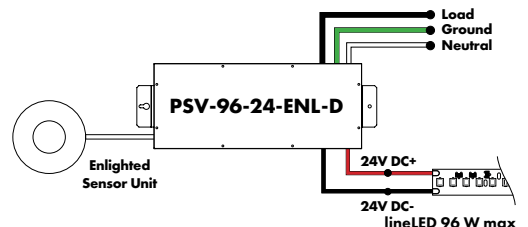

Power Supplies

See Power Supply instructions and spec sheet for wiring information. For a complete list of compatible dimmers, see Compatible Dimming Chart on the Resources page.

Non-Dimming Power Supply 120VAC - 277VAC

MODEL	POWER	OUTPUT	DIMMING	LOCATION
PSV - PSV Series	96 - 96 Watt	24 - 24 VDC	ND - Non Dimming	D - Damp

MODELS	96W
Length	14.40"
Width	5.20"
Depth	2.60"

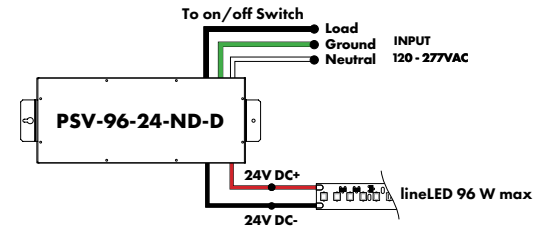

Luminii is a Lutron OEM Advantage Partner

Lutron Power Supplies 1%

MODEL
L3DA4U1UKL-CV240

HiLume™ 1% EcoSystem Voltage LED driver
40W max

MODELS	L3DA4U1UKL-CV240
Length	4.98"
Width	4.00"
Depth	2.62"

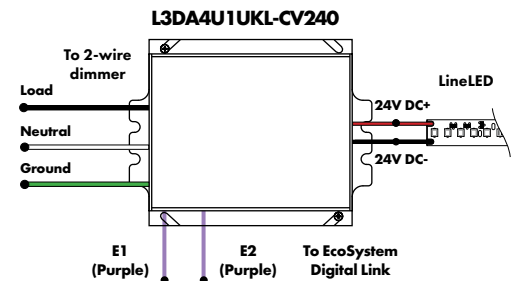

Luminii is a Lutron OEM Advantage Partner

Lutron Power Supplies 0.1%

MODEL
L3D0-96W24V-U

HiLume™ 0.1% EcoSystem Voltage LED Driver with Soft-On, Fade-to-Black™
96W max

MODELS	L3D0
Length	10.50"
Width	5.50"
Depth	2.00"

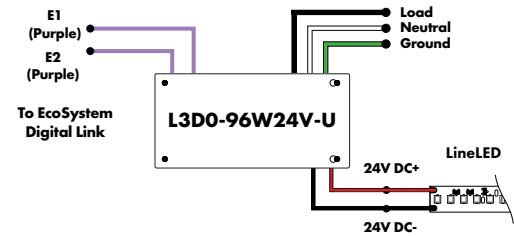

In-Ground Power Supplies

MODEL	POWER	OUTPUT	INPUT
IG - In ground CVE Series CVE - ELV Dimming DALI - eidoLED Dali dimming Both dims down to 0%	96X2 - 2 X 96 Watt	24 - 24 VDC	Blank - 120 V 277 - 240/277 V

MODELS	Dual Circuit
Length	8.40"
Width	8.30"
Depth	8.10"

