

Features

- Full length seamless lenses range from 2 to 12 feet.
- Choose either UP light or DOWN light with this architecturally, built to order LED luminaire.
- Not limited to straight runs, available in L nodes, providing freedom to create seamless configurations, available in 22.5in increments.
- Integrated drivers and controls make this fixture easy to install and widely applicable.
- The subtle flared Vesta Suspended fixtures feature a symmetrical, high-performance frosted lens which illuminates the surface evenly with no shadows or dark spots.
- Five Year Warranty.

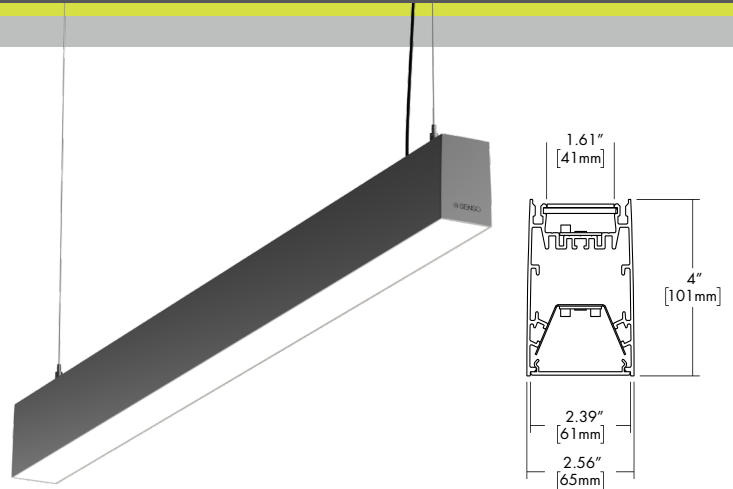

Finish Options

- White Black Silver



Technical Information

OUTPUT OPTIONS (Frosted Lens)		04	06	08	10	12
DOWN	Lumen Output	400 lm/ft	566 lm/ft	843 lm/ft	1034 lm/ft	1220 lm/ft
	Average Power Consumption	3.8 W/ft	5.7 W/ft	9.4 W/ft	12.0 W/ft	15.1 W/ft
	Efficacy	104 lm/W	100 lm/W	90 lm/W	87 lm/W	81 lm/W
UP	Lumen Output	454 lm/ft	628 lm/ft	788 lm/ft		
	Average Power Consumption	3.8 W/ft	5.6 W/ft	7.4 W/ft		
	Efficacy	117 lm/W	112 lm/W	106 lm/W		

OUTPUT OPTIONS (Asymmetric Lens)		04	06	08
DOWN	Lumen Output	433 lm/ft	648 lm/ft	800 lm/ft
	Average Power Consumption	8.1 W/ft	13.8 W/ft	17.3 W/ft
	Efficacy	54 lm/W	47 lm/W	46 lm/W
UP	Lumen Output	433 lm/ft	648 lm/ft	800 lm/ft
	Average Power Consumption	8.1 W/ft	13.8 W/ft	17.3 W/ft
	Efficacy	54 lm/W	47 lm/W	46 lm/W

TM-30					
CCT	Multiplier	CRI	R _f	R _g	R ₉
2700K	0.92	93+	92	100	50+
3000K	0.97	93+	92	103	50+
3500K	1.00	93+	93	102	50+
4000K	1.07	93+	92	101	50+

Ordering Code

Integral Driver Example: Fixture VSD-S-6FT-04-00-35K-F-N-WH-RDS-WH-AF5-WH-010S-NA

MODEL	LENGTH	OUTPUT DOWN ¹	OUTPUT UP ¹	CCT	LENS DOWN ²	LENS UP ²	FINISH
VSD-S - Vesta Dry, Suspended Up OR Down	2ft - 2 feet 4ft - 4 feet 6ft - 6 feet 8ft - 8 feet 10ft - 10 feet 12ft - 12 feet XX - System ¹³	04 - 400 lm/ft (3.8 W/ft) 06 - 566 lm/ft (5.7 W/ft) 08 - 843 lm/ft (9.4 W/ft) 10 - 1034 lm/ft (12 W/ft) 12 - 1220 lm/ft (15 W/ft) 00 - No Downlight	04 - 454 lm/ft (3.9 W/ft) 06 - 628 lm/ft (5.6 W/ft) 08 - 788 lm/ft (7.4 W/ft) 00 - No Uplight	27K - 2700K 30K - 3000K 35K - 3500K 40K - 4000K	F - Frosted Lens AS - Asymmetric Lens ^{4,5,6} BL - Black Lens N - No Lens ³	F - Frosted Lens AS - Asymmetric Lens ^{4,5,6} N - No Lens ³	Standard WH - White BK - Black SL - Silver
CANOPY/ HOUSING	CANOPY FINISH	SUSPENSION TYPE/HEIGHT	SUSPENSION FINISH	DRIVER		DRIVER OPTIONS	
RDS - Round Slim USQS - Unified Square Slim URDS - Unified Round Slim	Standard WH - White BK - Black SL - Silver	AF5 AC + Feed Cable, 5ft long AF8 AC + Feed Cable, 8ft long AF10 AC + Feed Cable, 10ft long	Standard CL - Feed Cable Clear WH - Feed Cable White BK - Feed Cable Black	010S - 0-10V, 1% Dimming, 120V/277V 0103 - 0-10V, 1% Dimming, 347V Only ⁷ 010L - EldoLED, 0-10V, Linear, 0.1% Dimming, 120V/277V 010G - EldoLED, 0-10V, Log, 0.1% Dimming, 120V/277V DALI - EldoLED, DALI protocol 2, DT-6, Log, 0.1% Dimming, 120V/277V LUTE - Lutron Hilume Ecodigital, 1% Dimming, 120V/277V DMX - EldoLED, DMX, 0.1% Dimming, 120V/277V		NA - None EMG - Emergency Driver ^{9,10} CSMB - Casambi ⁸ AWN - Athena ¹¹ MNOD - PIR Motion Sensor, Occupancy, Daylight Harvesting ¹²	

1 - Select only Down or Up output. Other must be 00.
2 - Select only Down or Up lens. Other must be N.
3 - When Down lens is N it will receive Filler plate.
4 - Asymmetric lens not compatible with 2ft length.
5 - Asymmetric lens not compatible with 10 or 12 output.
6 - Asymmetric lens not compatible with 010L/010G/DALI/LUTE/DMX

7 - 0103 Driver (347V) not available with 2ft length.
8 - CSMB with 010S/010L/010G/DALI drivers only.
9 - EMG not available with 0103/LUTE/DMX drivers.
10 - EMG Battery Back-Up not available on length 2ft, 4ft or 6ft, illuminates 4ft or 6ft section based on lumen output.
11 - AWNR contact manufacturer for build assistance - (MOD Only).
12 - MNOD contact manufacturer for build assistance - (MOD Only).
13 - Customizable configurations available, contact factory (MOD only).

CONTACT FACTORY FOR MORE OPTIONS.

Canopy

RDS
Round Slim Canopy

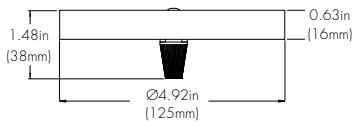

URDS
Unified Round Slim

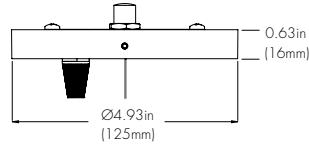

USQS
Unified Square Slim

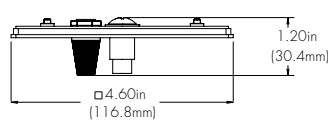

Lens Down

F
Frosted Lens

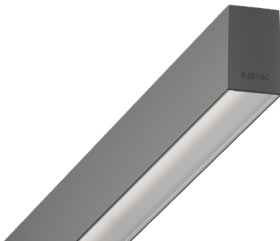

AS
Asymmetric Lens

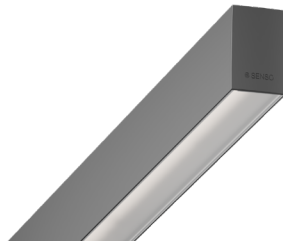

BL
Black Lens



Lens Up

F
Frosted Lens

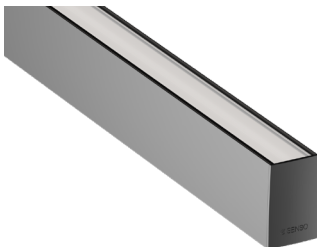

AS
Asymmetric Lens

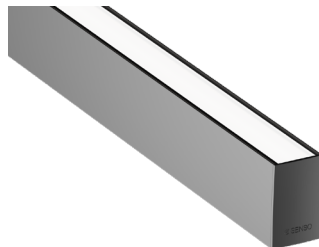

Cut Lengths

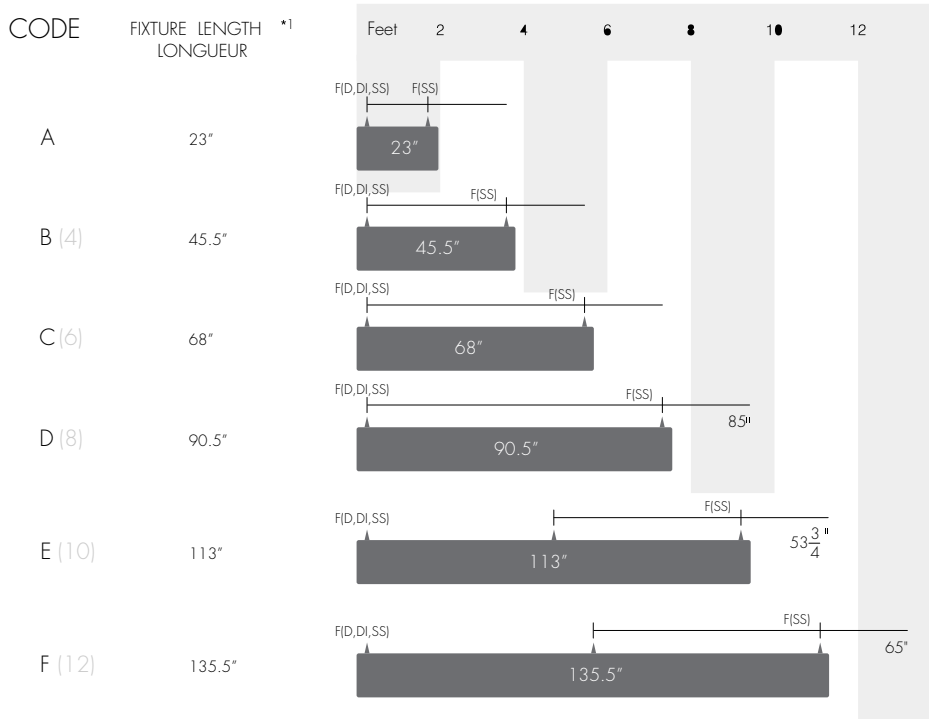

Legend

- ▲ : Suspension Point
- F() : Feed Point
- D : Direct
- DI : Direct / Indirect
- SS : Separate Switching

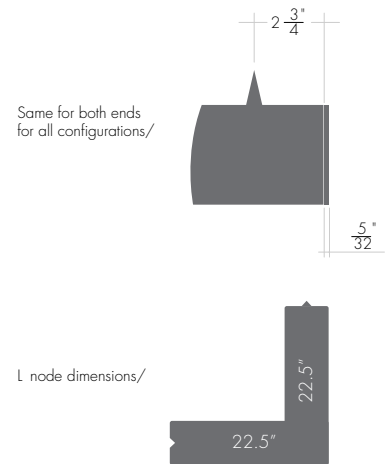

*1 Not including end-caps. End-caps are an additional 5/32"

For custom lengths please call customer service. Cover plates will be added to each end to avoid dark spaces on lense.

Sensor adds 3.75" to standard vesta length

Standard Finish

BK
Black

WH
White

SL
Silver

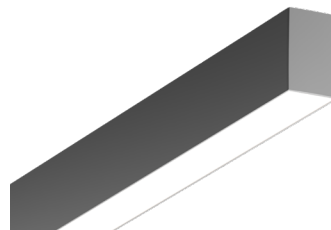
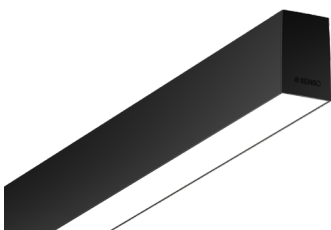

TM-30

2700K

COLOR VECTOR GRAPHIC

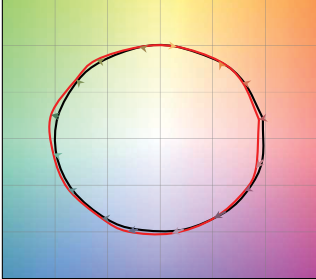

— Reference Source — Test Source

3000K

COLOR VECTOR GRAPHIC

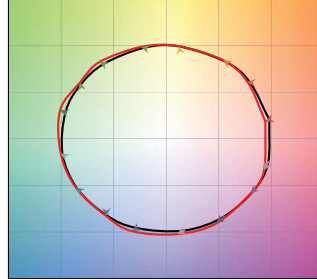

— Reference Source — Test Source

3500K

COLOR VECTOR GRAPHIC

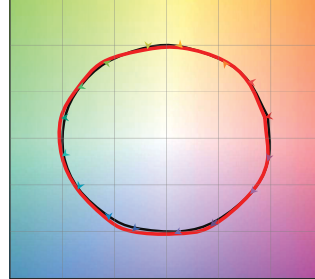

— Reference Source — Test Source

4000K

COLOR VECTOR GRAPHIC

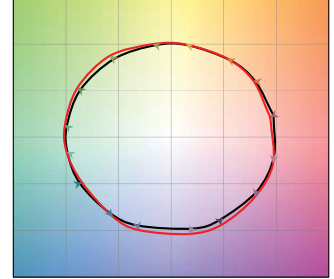

— Reference Source — Test Source

Photometry

Static White Down Frosted Lens

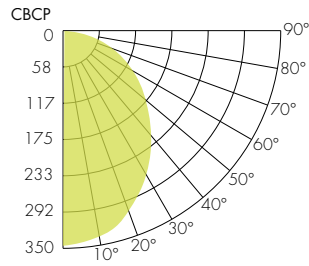
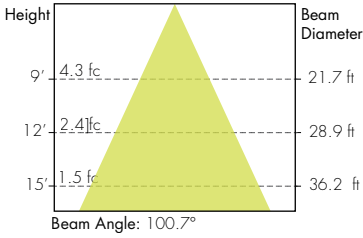

Static White Up Frosted

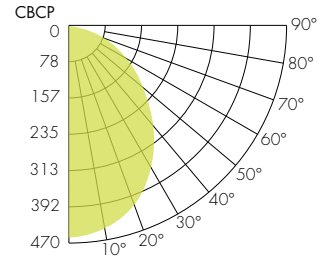
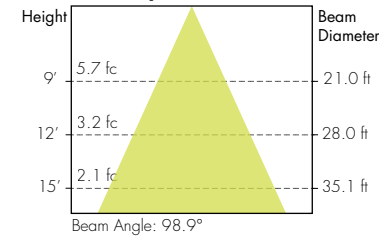

Static White Down Asymmetric Lens

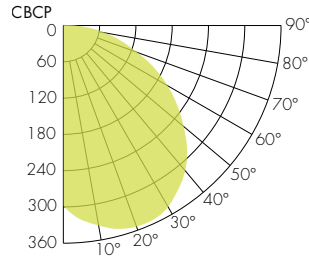
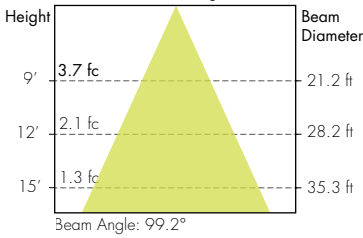

Static White Up Asymmetric

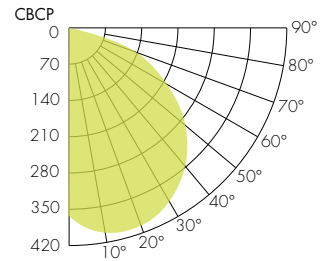
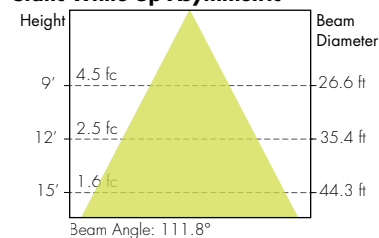

Static White Black Lens

