

Features

- Full length seamless lenses range from 2 to 12 feet.
- Not limited to straight runs, available in L nodes, providing freedom to create seamless configurations, available in 22.5in increments.
- Integrated drivers and controls make this fixture easy to install and widely applicable.
- Features a symmetrical, high-performance frosted lens which illuminates the surface evenly with no shadows or dark spots.
- Five Year Warranty.

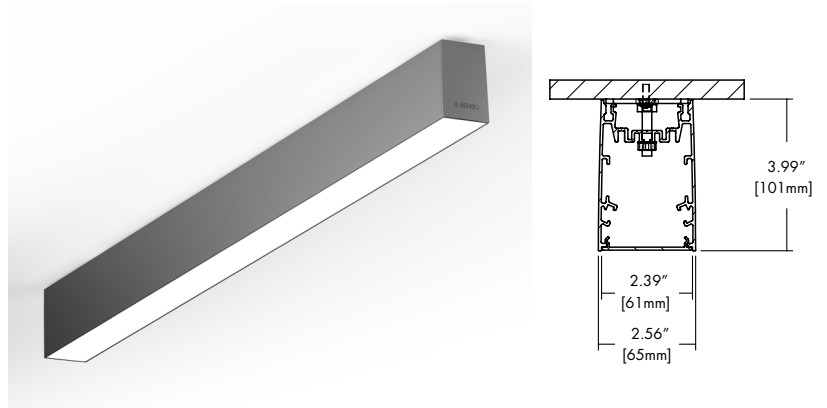

Finish Options

White Black Silver



Technical Information

OUTPUT OPTIONS	TW04	TW06	TW08
Lumen Output	418 lm/ft	592 lm/ft	776 lm/ft
Average Power Consumption	2.5 W/ft	3.5 W/ft	4.8 W/ft
Efficacy	20 lm/W	21 lm/W	21 lm/W

CCT	CRI	TM-30		
		R _f	R _g	R ₉
2700K	91	90	96	59
6500K	93	87	97	73

Ordering Code

Integral Driver Example: Fixture VSD-SM-4FT-04-27K-F-CH-WH-0103-NA

Fixture

MODEL	LENGTH	OUTPUT	CCT	LENS	MOUNTING	BODY FINISH
VSD-SM - Vesta Dry, Surface Mount	4ft - 4 feet 6ft - 6 feet 8ft - 8 feet 10ft - 10 feet 12ft - 12 feet XX - System ⁷	TW04 - 418 lm/ft (4.8 W/ft) ² TW06 - 592 lm/ft (7.2 W/ft) TW08 - 776 lm/ft (9.6 W/ft)	27K65K - Tunable White, 2700K-6500K ¹	F - Frosted Lens	SM - Surface Mount	Standard WH - White BK - Black SL - Silver

DRIVER

DRIVER OPTIONS⁶

010S - 0-10V, 1% Dimming, 120/277V³
DALI - E1d0LED, DALI protocol 2, DT-6, Log, 0.1% Dimming, 120/277V
DMX - E1d0LED, DMX, 0.1% Dimming, 120V/277V

NA - None
CSMB - Casambi⁴
MNOD - PIR Motion Sensor, Occupancy, Daylight Harvesting⁵

1 - Tunable White output numbers are at representative of 4000K.
2 - Tunable White at 4ft length, not available with Output TW04.
3 - 010S driver is only available with driver option CSMB.

4 - CSMB with 010S/DALI drivers only.
5 - MNOD contact manufacturer for build assistance - (MOD Only).
6 - AVNDR contact manufacturer for build assistance - (MOD Only).
7 - Customizable configurations available, contact factory (MOD only).

CONTACT FACTORY FOR MORE OPTIONS.

Lens

F
Frosted Lens

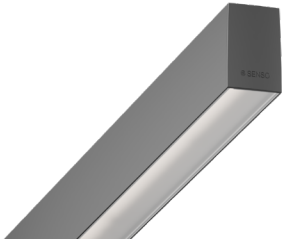

AS
Asymmetric Lens

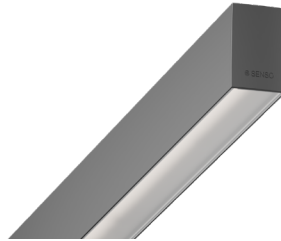

BL
Black Lens

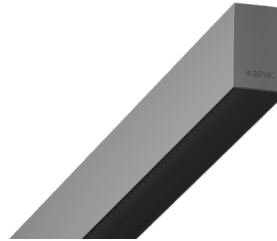

Cut Lengths

CODE	FIXTURE LENGTH LONGUEUR	Feet	2	4	6	8	10	12
A	22.5"							
B (4)	44.5"							
C (6)	66.5"							
D (8)	88.5"							
E (10)	110.5"							
F (12)	132.5"							

Legend

- ▲ : Suspension Point
- F() : Feed Point
- D : Direct
- DI : Direct / Indirect
- SS : Separate Switching

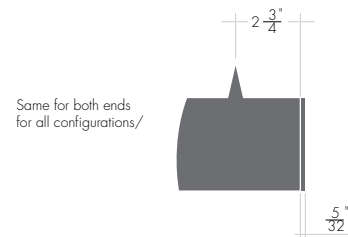

L node dimensions/



*1 Not including end-caps. End-caps are an additional 5/32"

For custom lengths please call customer service. Cover plates will be added to each end to avoid dark spaces on lense.

Sensor adds 3.75" to standard vesta length

VESTA

DRY SURFACE MOUNT
TUNABLE WHITE

Standard Finish

BK
Black

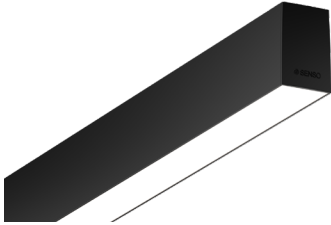

WH
White



SL
Silver

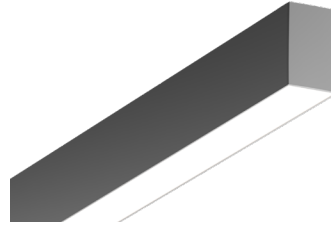

TM-30

Tunable White 2700K

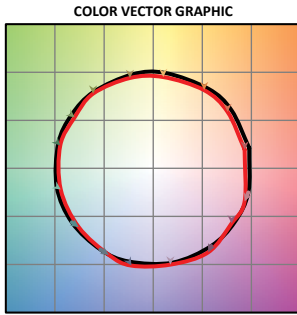

—Reference Source —Test Source

Tunable White 6500K

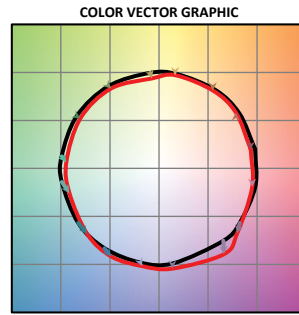

—Reference Source —Test Source

Photometry

Tunable White Down

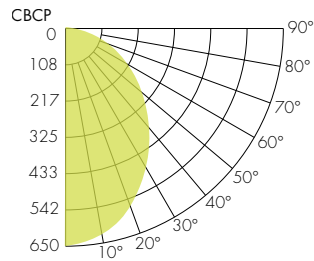
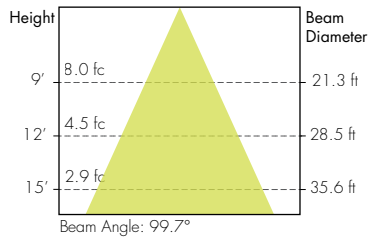

Photometry

10° Faceted Reflector

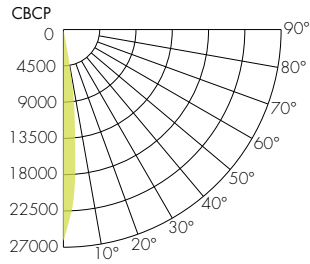
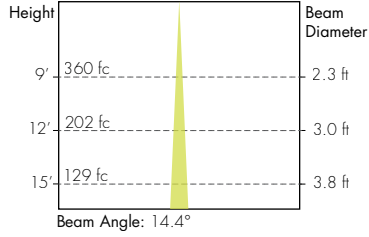

30° Smooth Reflector

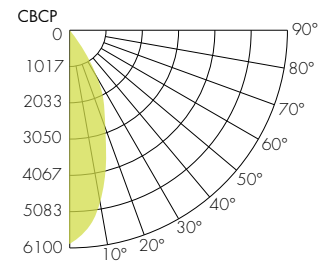
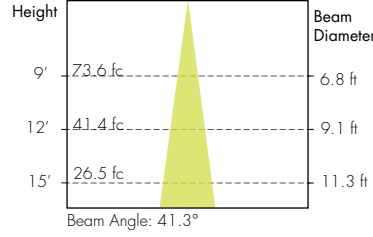

18° Faceted Reflector

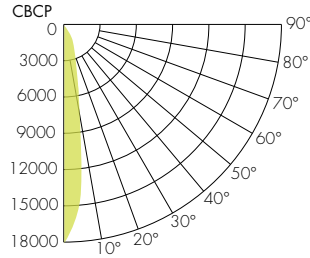
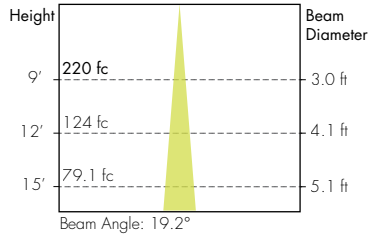

45° Smooth Reflector

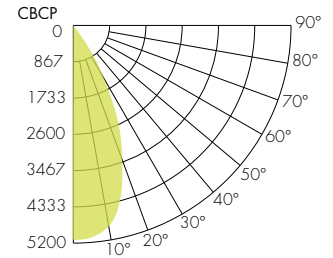
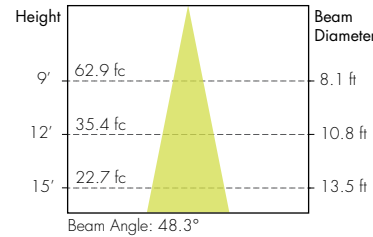

30° Faceted Reflector

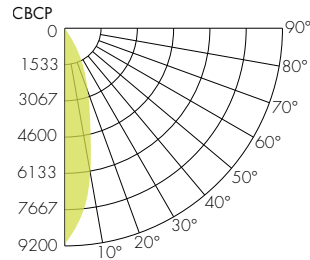
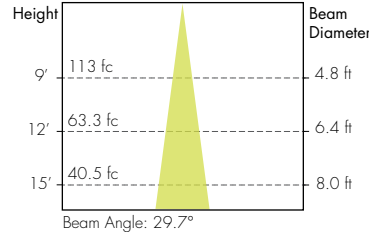

80° Smooth Reflector

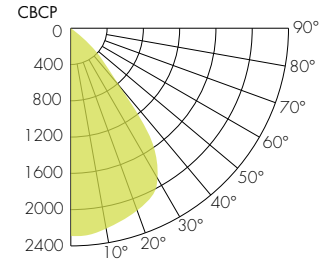
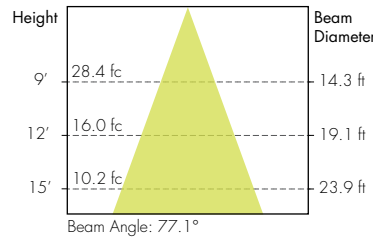

45° Faceted Reflector

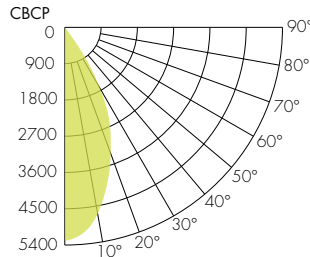
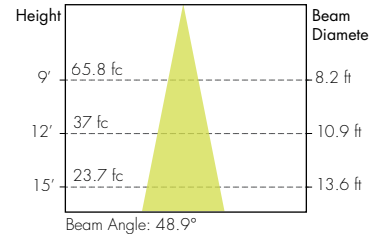

60° Faceted Reflector

