



**Features**

- Deep Recessed track supports Stenos directional and ambient modules, as well as track heads
- Minimalist and narrow track seamlessly integrates into environments while concealing modules
- Two channel track allows independent dim control for groups of modules when paired with appropriate power supplies
- Custom drawing and approval is required for every STENOS Track System prior to order acceptance.
- Snap-in Electrical Joiners include magnetic black/white Cover Plates to maintain clean aesthetic.
- 24 VDC Class 2 power supply
- 4A max on track
- 96W max on track
- For ceiling thicknesses from 0.375" up to 1.25"
- Dry location only



RoHS

**Finish Options**

- Black powder coated
- White powder coated

**Product Dimensions**

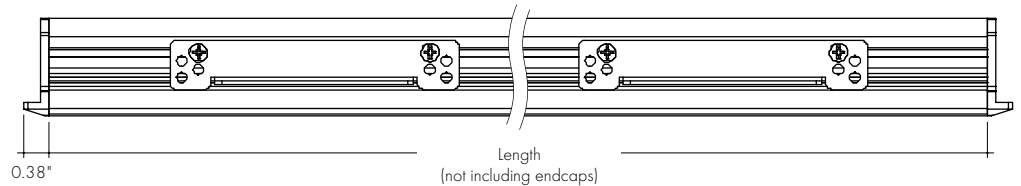
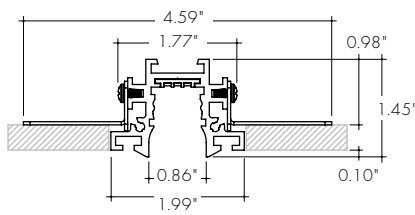

Straight Run

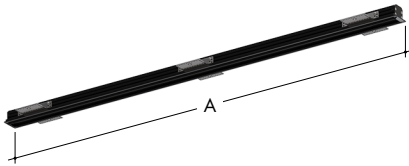

L Shape



U Shape

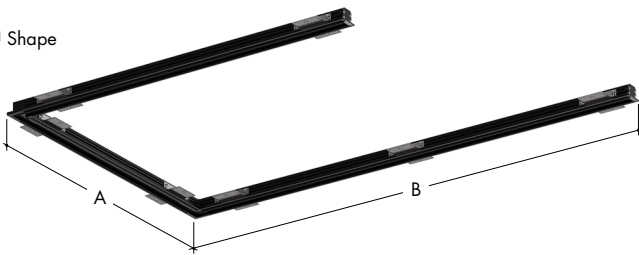

Rectangle Shape

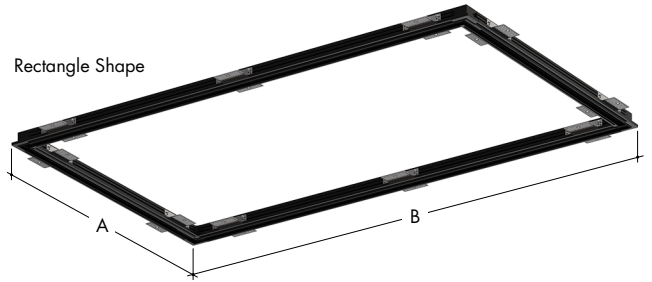

**Ordering Code**

example: STD-R-22-BK-UNV-113-C-XXXXXX

MODEL <sup>1</sup>	SHAPE	OVERALL LENGTH <sup>2</sup>	FINISH	POWER SUPPLY <sup>3</sup>	WATTAGE	SERIAL NUMBER
STD - Stenos Deep Recessed Trimless Track	S - Straight Run R - Rectangle Shape L - L Shape U - U Shape	- Overall run length of system/shape (rounded up to the nearest foot)	BK - Black WH - White	ND - Non-Dim, PS-ND-D-96-24 UNV - Phase and 0-10V, 1%, PS-UNI-W-96 010V-LIN - 0-10V Linear, 0.1%, PS-010V-LIN-D-96-24 010V-LOG - 0-10V Logarithmic, 0.1%, PS-010V-LOG-D-96-24 010V-LIN-AWNR - 0-10V Linear, 0.1%, PS-010V-LIN-D-96-24-AWNR 010V-LOG-AWNR - 0-10V Linear, 0.1%, PS-010V-LOG-D-96-24-AWNR DALI - DALI, 0.1%, PS-DALI-D-96-24 DMX - DMX, 0.1%, PS-DMX-D-96-24 L3D - Lutron EcoSystem, 1%, L3DA4U1UKL-CV240 2CH010V - 2 Channel 0-10V, 0.1%, PS-010V-2CH-D-96-24 2CHDMX - 2 Channel DMX, 0.1%, PS-DMX-D-96-24 2CH010V-AWNR - 2 Channel 0-10V with Lutron Athena, 0.1%, PS-010V-2CH-D-96-24-AWNR	- (see page 3 for details)	Serial Number, entered by Luminii

1- Custom drawing and approval is required for every STENOS Track System prior to order acceptance. Allow 2 weeks [typical] for custom drawing generation/confirmation process. Use STENOS Track System Sketch Grid to convey as many details as possible including: shape, dimension of each leg, desired location of power feeds, and location of track modules (Directional, Ambient, Track Heads).  
 2- Mechanical joiners are required for sections longer than 12ft.  
 3- Power supplies are 120-277 VAC input, unless otherwise noted.

Product Dimensions

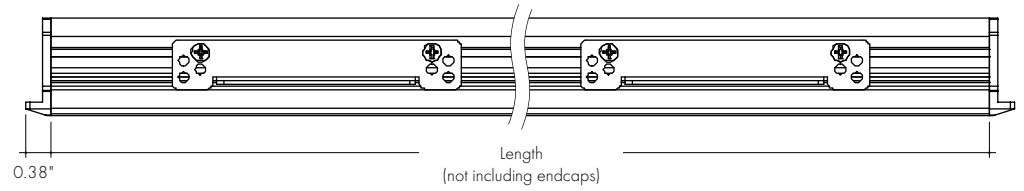
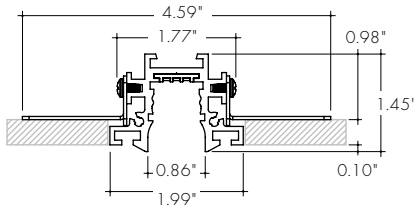

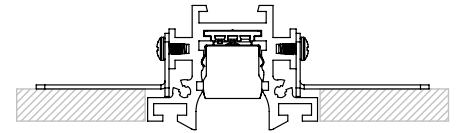
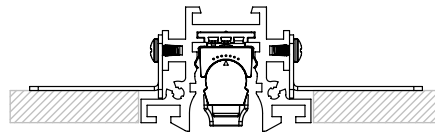
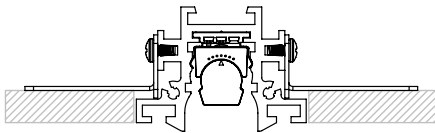

Stenos Deep Trimless Track with Directional Module and Louver

Stenos Deep Trimless Track with Ambient Module and Louver

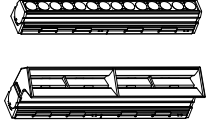
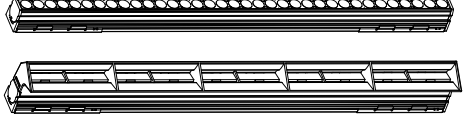
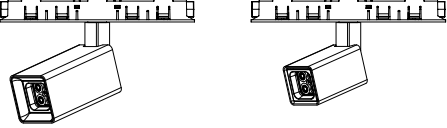
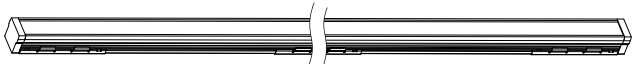
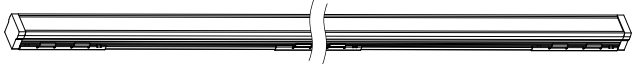

Wattage Calculation Guide

Stenos Track Module	Wattage	Lumens (3000K)	Length	Reference
<b>STENOS 3" Directional Module</b>	2.6 W	250 lm	2.5 in	
<b>STENOS 5" Directional Module &amp; STENOS 5" Wall Wash Module</b>	5.4 W	520 lm 275 lm	4.8 in	
<b>STENOS 12" Directional Module &amp; STENOS 12" Wall Wash Module</b>	13.0 W	1260 lm 665 lm	11.8 in	
<b>STENOS 1" Track Head Long</b> 15° optic Regressed Baffle	6.6 W	565 lm	4.9 in	
<b>STENOS 1" Track Head Short</b> 15° optic Regressed Baffle	5.2 W	458 lm		
<b>STENOS 24" Ambient Module SO</b>	5.5 W	475 lm	24.4 in	
<b>STENOS 24" Ambient Module HO</b>	12.3 W	1000lm	24.4 in	
<b>STENOS 48" Ambient Module SO</b>	11.0 W	950 lm	48.0 in	
<b>STENOS 48" Ambient Module HO</b>	24.7 W	2025 lm	48.0 in	

Wattage Calculation Guide (Example)

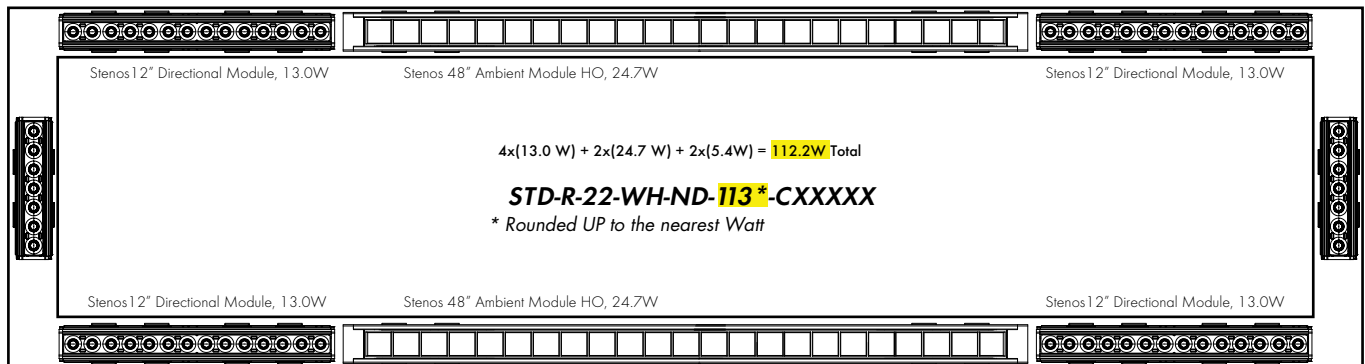

Factory Built Sections

Straight Run

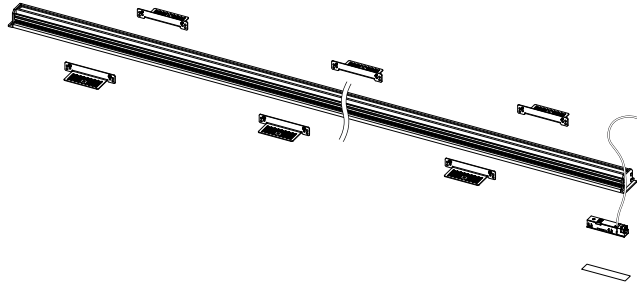

L Shape

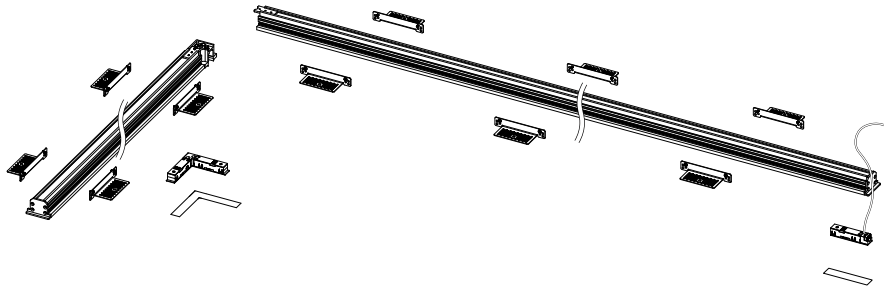

U Shape

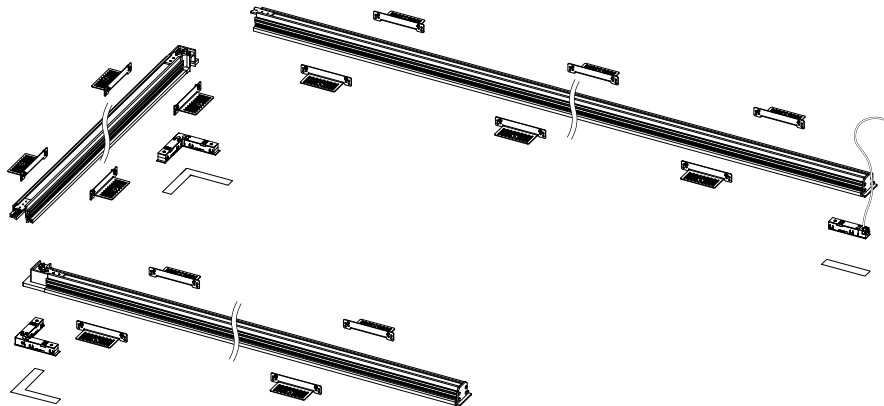

Rectangle Shape

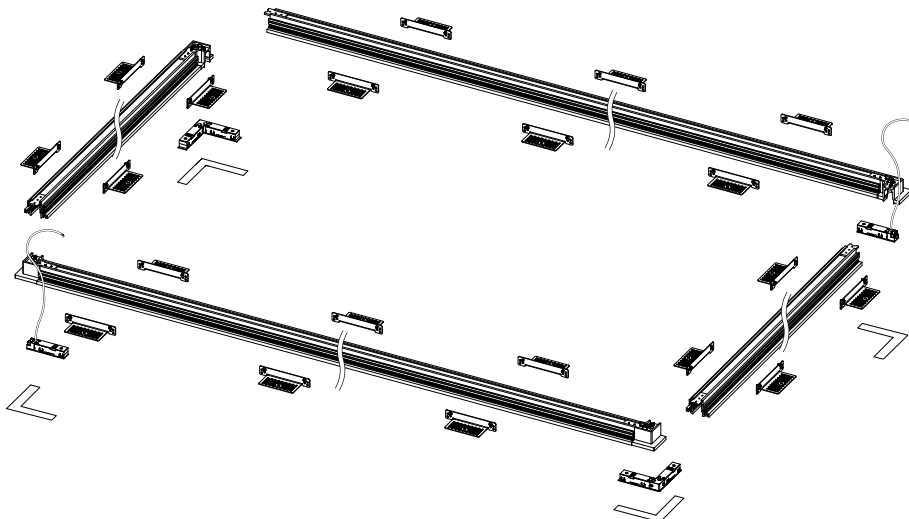

**Power Supplies**

See Power Supply instructions and spec sheet for wiring information. For a complete list of compatible dimmers, see Compatible Dimming Chart on the Resources page.

**Single Channel Control**

**-ND**  
Non-Dimming, 120-277VAC,  
PS-ND-D-96-24

MODELS	96W
Length	14.40"
Width	5.20"
Depth	2.60"

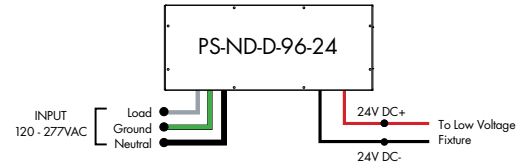

**-UNV**  
Universal, Phase (MLV/ELV/Triac) and 0-10V, 1% 120-277VAC,  
PS-UNI-W-96-24

MODELS	96W
Length	8.66"
Width	3.73"
Depth	1.61"

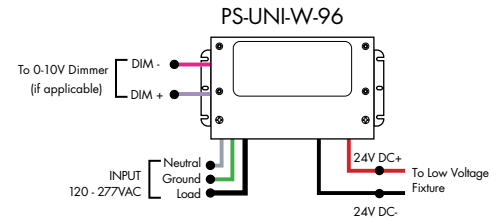

**-010V-LIN, -010V-LOG**  
0-10V, 0.1% Linear/Logarithmic, 120 - 277VAC,  
PS-010V-LIN-D-96-24, PS-010V-LOG-D-96-24

MODELS	96W
Length	14.40"
Width	5.20"
Depth	2.60"

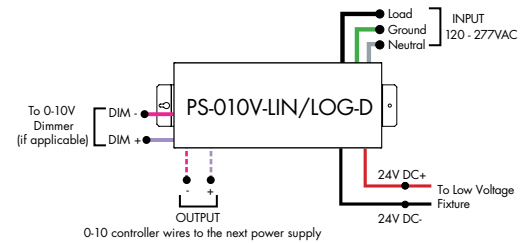

**-010V-LIN-AWNR, -010V-LOG-AWNR**  
0-10V, 0.1% Linear/Logarithmic, 120 - 277VAC,  
PS-010V-LIN-D-96-24-AWNR, PS-010V-LOG-D-96-24-AWNR

MODELS	96W
Length	14.40"
Width	5.20"
Depth	2.60"

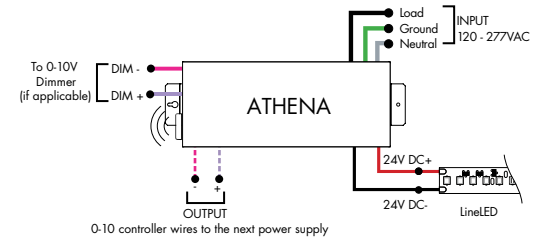

**-DALI**  
DALI, 0.1%, 120 - 277VAC,  
PS-DALI-D-96-24

Model	96W
Length	14.40"
Width	5.20"
Depth	2.60"

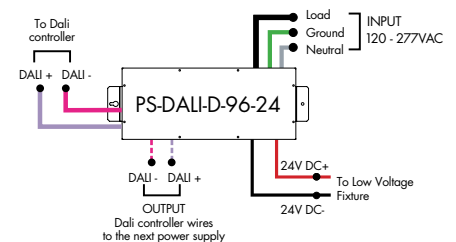

**Power Supplies**

See Power Supply instructions and spec sheet for wiring information. For a complete list of compatible dimmers, see Compatible Dimming Chart on the Resources page.

**-DMX**

DMX, 0.1%, 120 - 277VAC, PS-DMX-D-96-24

<b>MODELS</b>	<b>96W</b>
<b>Length</b>	14.40"
<b>Width</b>	5.20"
<b>Depth</b>	2.60"

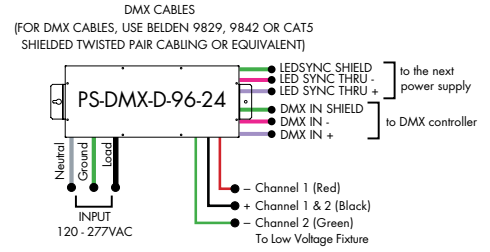

**-L3D**

LUTRON ECOSYSTEM, 1%, L3D

<b>MODELS</b>	<b>96W</b>
<b>Length</b>	4.98"
<b>Width</b>	4.00"
<b>Depth</b>	2.62"

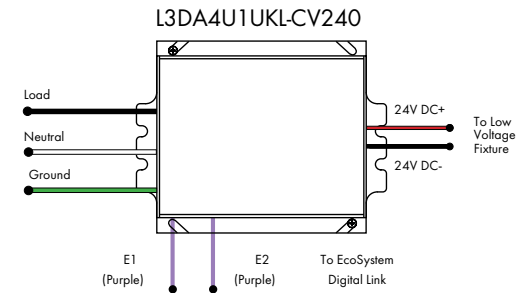

**Two Channel Control**

**-2CH010V**

2 CHANNEL 0-10V, 0.1% LINEAR, 120-277VAC, PS-010V-2CH-D-96-24

<b>MODELS</b>	<b>96W</b>
<b>Length</b>	14.40"
<b>Width</b>	5.20"
<b>Depth</b>	2.60"

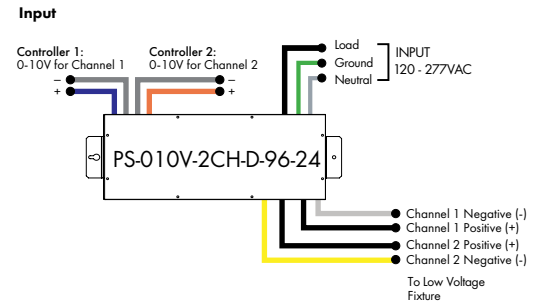

**-2CHDMX**

2 CHANNEL DMX, 0.0%, 120-277VAC, PS-DMX-D-96-24

<b>MODELS</b>	<b>96W</b>
<b>Length</b>	14.40"
<b>Width</b>	5.20"
<b>Depth</b>	2.60"

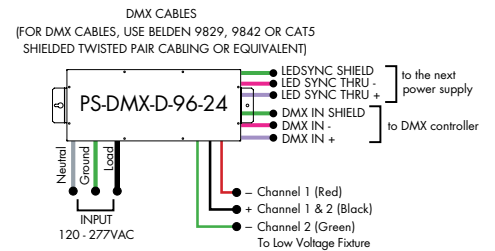

**-2CH010V-AWNR**

2 CHANNEL 0-10V WITH LUTRON ATHENA, 0.1%, PS-010V-2CH-D-96-24-AWNR

<b>MODELS</b>	<b>96W</b>
<b>Length</b>	14.40"
<b>Width</b>	5.20"
<b>Depth</b>	2.60"

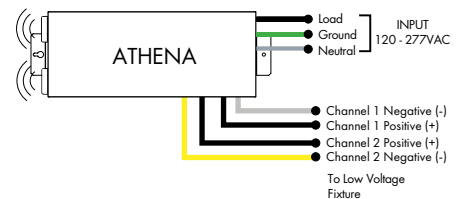

**Track Components (for field configurable systems)**

To minimize voltage drop, it is recommended to not exceed 24ft of track per power feed or 3 track joiners per power feed.

**EC-STD-H3-XX**  
Recessed Deep Trimless End Caps

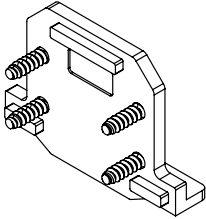

Blank End Cap for ending a Recessed Deep Trimless run

**JOIN-M-ST**  
Mechanical Joiner Brackets

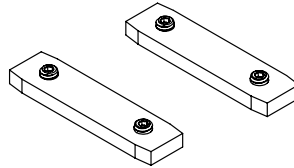

Used for mechanically joining adjacent Track sections

**TC-96-XX**  
Track Cover, 96"

**TC-144-XX**  
Track Cover, 144"

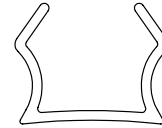

Track Covers ship complete with Recessed Deep Trimless Track and cover unoccupied sections of track. They are field cuttable and can be used to protect channel during the mudding process. Additional can be ordered, if necessary.

**JOIN-M-L-STD-FF-XX**  
Recessed Deep Trimless Mechanical L Joiner

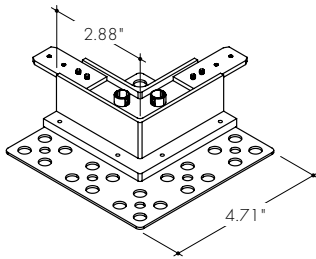

For creating a 90° in-plane corner. For use with FF Front Flange and STJOIN-E-F Electrical Joiner only.

**JOIN-M-L-STD-XX**  
Recessed Deep Trimless Mechanical L Joiner

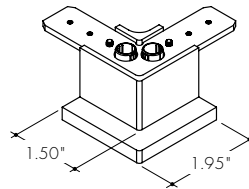

For creating a 90° in-plane corner  
For use with MF Backer Flange only.

**JOIN-M-W-STD-XX**  
Recessed Deep Trimless Mechanical Wall to Ceiling Joiner

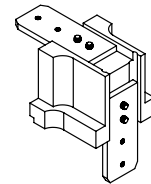

For creating a 90° Wall to Ceiling corner

**STD-48/95/144-FF/MF-XX**  
Stenos Deep Trimless Track, Recessed

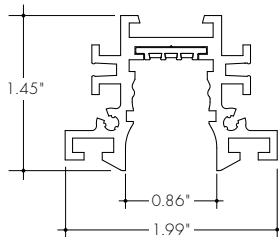

**MB-STL**  
Mounting Bracket, Hanger Bar or Threaded Rod

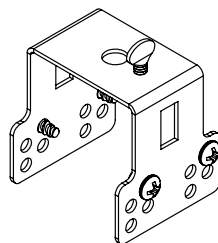

Hanger bars ordered separately. Threaded rod and nuts not included  
For use every 30" and 8" from each end.

**PF-HB-ALL**  
Hanger Bars for use with MB-STL Mounting Bracket

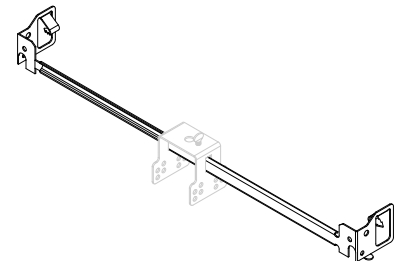

For use to mount to joists. MB-STL not included.

XX	Color
WH	White
BK	Black

**Track Components**

To minimize voltage drop, it is recommended to not exceed 24ft of track per power feed or 3 track joiners per power feed.

**ST-JOIN-E-P**  
Electrical Power Feed, with black and white Cover Plates

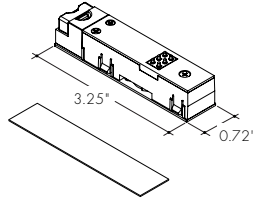

For use with 18AWG field wires with max outer diameter 0.3" (cable and power feed do not ship pre-assembled)

**ST-JOIN-E-P-72**  
Electrical Power Feed, 72" Plenum Cable

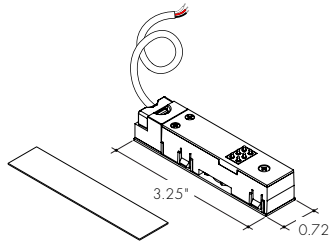

with Black and White cover plates (cable and power feed do not ship pre-assembled)

**ST-JOIN-E-S**  
Electrical Joiner, Straight, with black and white Cover Plates

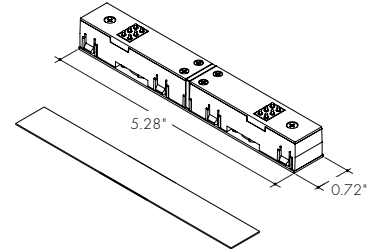

For electrically joining adjacent Track sections

**ST-JOIN-E-L**  
Electrical Joiner, L with black and white Cover Plates

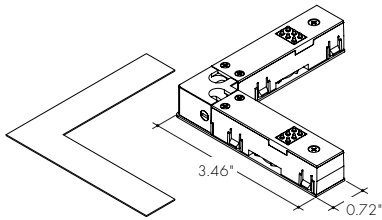

For use with Mechanical L Joiner

**ST-JOIN-E-F**  
Electrical Joiner, Flexible with black and white Cover Plates

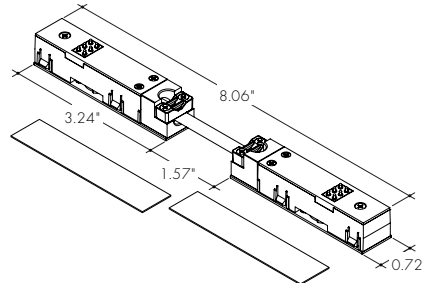

For use with Mechanical L Joiner or Wall to Ceiling Joiner

**Wiring and Multiple Channels**

For **single channel** use, connect black and white power feed wires.

For **two channel** use, connect per wiring diagram in the Two Channel Control section of power supplies

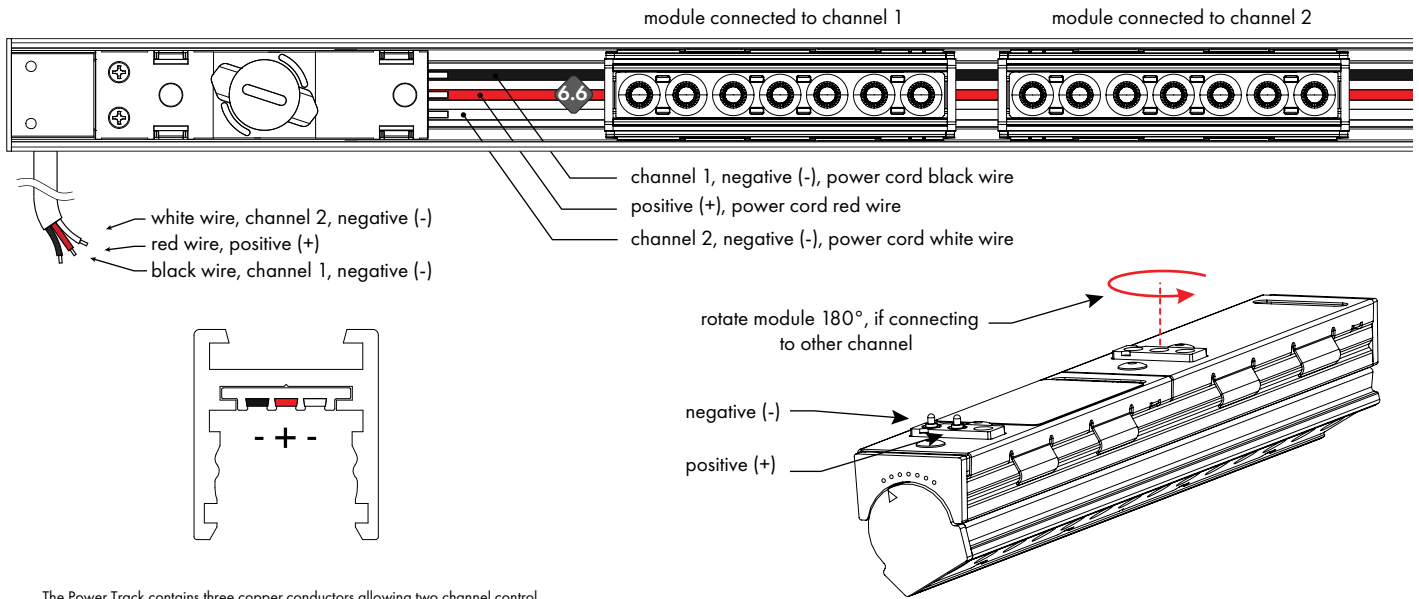

The Power Track contains three copper conductors allowing two channel control .

- Center conductor is common positive (+), connected to power cord red wire
- One outer conductor is channel 1 negative (-), connected to power cord black wire
- Other outer conductor is channel 2 negative (-), connected to power cord white wire

Select control channel for Stenos Directional and Ambient Modules by rotating them 180°

For **two channels use**, connect per wiring diagram in the Two Channel Control section of power supplies  
For **single channel use**, connect black and white power feed wires.



For single channel use, connect black and white wires



**STENOS Track System Sketch Grid**

Use grid below to sketch out details of the STENOS Track System. Include as many details as possible such as:

- Shape
- Dimensions of each leg
- Location of Power Feeds
- Location and Type of Track Modules (Directional, Ambient, Track Heads)
- Ceiling Thickness (for Trimless Tracks)

**Note:** 96W max, 24ft max,  
and 3 electrical joiners max  
per power feed  
See example on next page

**Custom drawing and approval is required for every STENOS Track System prior to order acceptance**

A large grid for sketching the STENOS Track System details. The grid consists of 20 columns and 30 rows of small squares, providing a space for technical drawing.

**STENOS Track System Sketch Grid (Example)**

Use grid below to sketch out details of the STENOS Track System. Include as many details as possible such as:

- Shape
- Dimensions of each leg
- Location of Power Feeds
- Location and Type of Track Modules (Directional, Ambient, Track Heads)
- Ceiling Thickness (for Trimless Tracks)

**Note:** 96W max, 24ft max, and 3 electrical joiners max per power feed

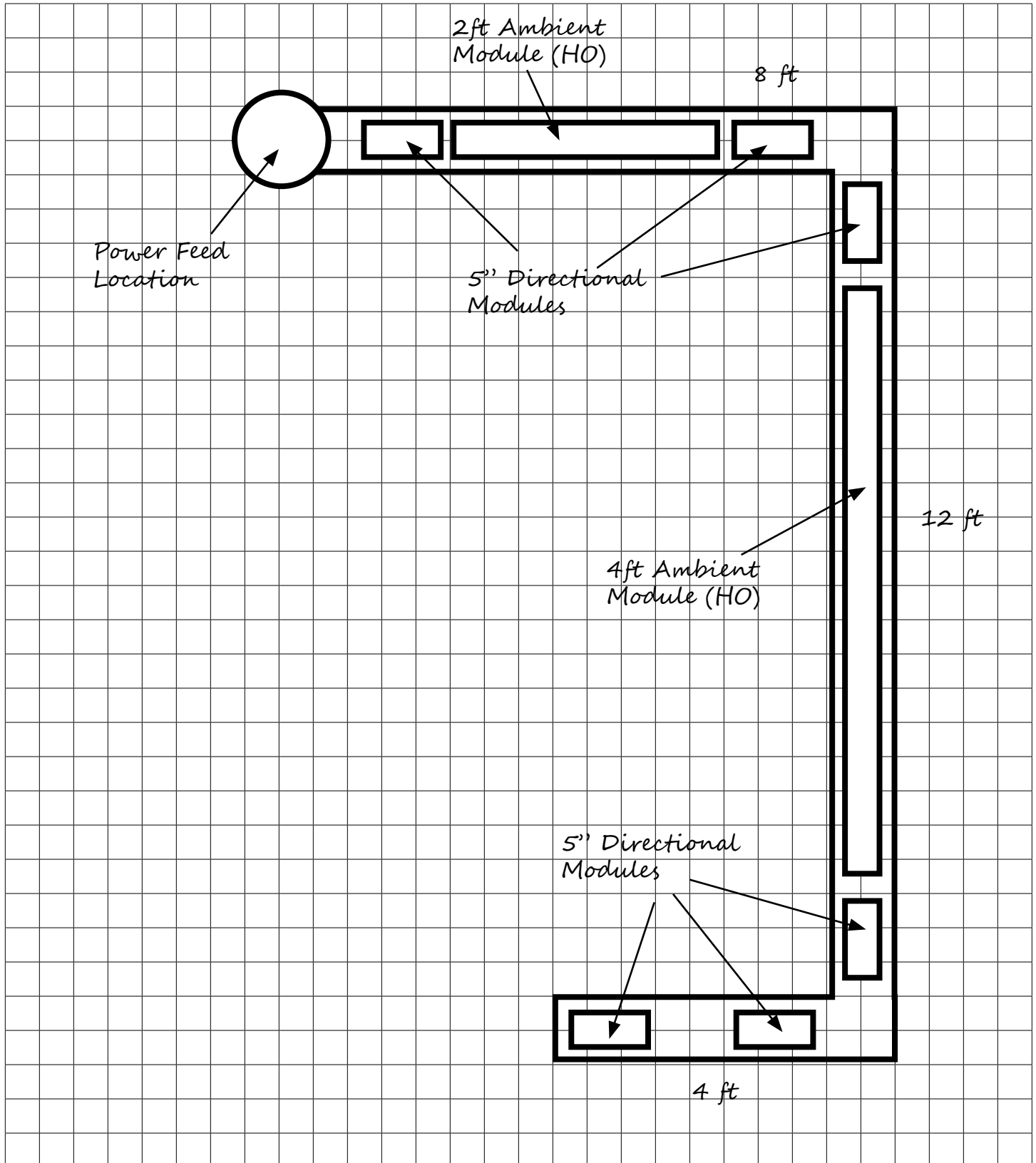

Additional Stenos Products



(left to right)  
Stenos Recessed Deep Trimless Track  
Stenos Recessed Trimless Track  
Stenos Recessed Trimmed Track  
Stenos Surface Mount Track  
Stenos Suspended Track



Stenos Directional Module

Stenos Directional Module with Louver

Stenos Directional Module with Wall Wash

Stenos Ambient Module

Stenos Ambient Module with Louver

