

STACKO STRAIGHT FIXED END

16° NARROW BEAM

STATIC WHITE

OVERVIEW

Stacko Straight Fixed End is a Constant Current miniature display lighting product. It has four beam distributions and is a part of the modular Stacko Collection allowing users to 'stack' products together to create unique lighting set-ups that comes as standard in white, black and brushed aluminium. There are 5 light engines totalling 510lm | 5.60W. Each narrow beam in our 102lm light engine has a peak intensity of 794cd. This 'End' module closes the circuit and does not accept further modules. There can only be a maximum of 10 light engines per Stacko circuit or driver. The luminaire is compatible with our Minipoint system that enables a plug and play setup where luminaires can be swapped to suit changing lighting requirements.



UK PART L	Part L1A / L1B (Dwellings)	EXEMPT
	Part L2A (General)	EXEMPT
	Part L2A (Display)	EXEMPT



PERFORMANCE

FWHM	16°	Category	IP20
Luminous Flux	Total: 470 lm Per Light Engine: 94 lm	Material	Machined AL 6063-T6 Machined Brass
Light Engines	5	Finishes	Brushed Aluminium White RAL9010 Matte Black Anodised Rubbed Bronze* Polished Brass* Brushed Brass * Polished Nickel*
CCT	2700K 3000K	Weight	79g 0.17lb
CRI Min.	95 TYP	Mounting	Minipoints
Drive Current	350 mA	Movement	Pan 360° Tilt N/A
Nom. Voltage	16 V	Lockable	N/A
Max. Wattage	5.60 W	Accessories	N/A N/A
Dimming	0-10V DALI	TM65 TM66	8.1kgCO2e 2.4
Driver Type	Constant Current Remote	Lifetime	L90B10 100,000hrs 5 year warranty
Class	SELV Class III		

DIMENSIONS

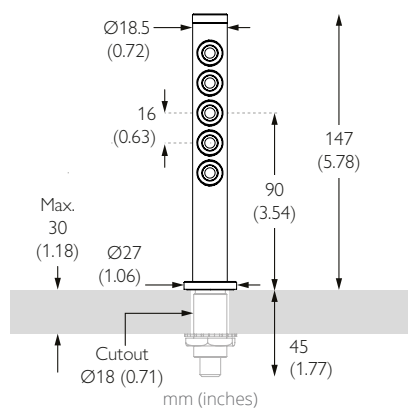

PHOTOMETRY

CCT	Multiplier
2700K	x1.00
3000K	x1.00

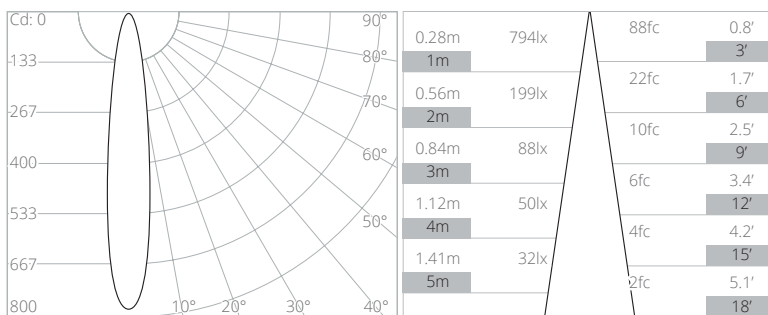

Data at 3000K, Single Light Engine

LUMINAIRE ORDER CODE

Model	Finish	CCT	Beam Angle
1005-E	-	-	-
	WH White RAL 9010	2795 2700K 95CRI	16 Narrow
	EBA Black RAL 9005	3095 3000K 95CRI	23 Medium
	AL Brushed Aluminium		45 Flood
	RB Rubbed Bronze		90 Wide Flood
	PB Polished Brass		
	SB Brushed Brass		

MINIPOINT ORDER CODE

Model	Finish
770-M-A-DC	-
	WH White RAL 9010
	EBA Black RAL 9005
	AL Brushed Aluminium
	RB Rubbed Bronze
	PB Polished Brass
	SB Brushed Brass

Example Code: 1005-E-WH-309516

*Premium & custom finishes are built to order, subject to an extended lead time & MOQ
See Drivers, Power Supplies and Accessories sections for further order codes

Example Code: 770-M-A-DC-WH

STACKO STRAIGHT FIXED END

23° MEDIUM BEAM

STATIC WHITE

OVERVIEW

Stacko Straight Fixed End is a Constant Current miniature display lighting product. It has four beam distributions and is a part of the modular Stacko Collection allowing users to 'stack' products together to create unique lighting set-ups that comes as standard in white, black and brushed aluminium. There are 5 light engines totalling 510lm | 5.60W. Each medium beam in our 102lm light engine has a peak intensity of 359cd. This 'End' module closes the circuit and does not accept further modules. There can only be a maximum of 10 light engines per Stacko circuit or driver. The luminaire is compatible with our Minipoint system that enables a plug and play setup where luminaires can be swapped to suit changing lighting requirements.



UK PART L	Part L1A / L1B (Dwellings)	EXEMPT
	Part L2A (General)	EXEMPT
	Part L2A (Display)	EXEMPT



PERFORMANCE

FWHM	23°	Category	IP20
Luminous Flux	Total: 460 lm Per Light Engine: 92 lm	Material	Machined AL 6063-T6 Machined Brass
Light Engines	5	Finishes	Brushed Aluminium White RAL9010 Matte Black Anodised Rubbed Bronze* Polished Brass* Brushed Brass * Polished Nickel*
CCT	2700K 3000K	Weight	79g 0.17lb
CRI Min.	95 TYP	Mounting	Minipoints
Drive Current	350 mA	Movement	Pan 360° Tilt N/A
Nom. Voltage	16 V	Lockable	N/A
Max. Wattage	5.60 W	Accessories	N/A N/A
Dimming	0-10V DALI	TM65 TM66	8.1kgCO2e 2.4
Driver Type	Constant Current Remote	Lifetime	L90B10 100,000hrs 5 year warranty
Class	SELV Class III		

DIMENSIONS

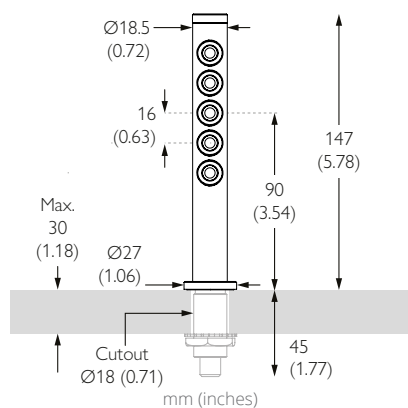

PHOTOMETRY

CCT	Multiplier
2700K	x1.00
3000K	x1.00

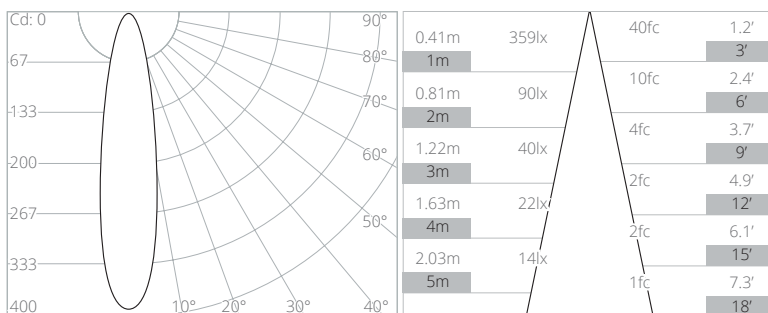

Data at 3000K, Single Light Engine

LUMINAIRE ORDER CODE

Model	Finish	CCT	Beam Angle
1005-E	-	-	-
	WH White RAL 9010	2795 2700K 95CRI	16 Narrow
	EBA Black RAL 9005	3095 3000K 95CRI	23 Medium
	AL Brushed Aluminium		45 Flood
	RB Rubbed Bronze		90 Wide Flood
	PB Polished Brass		
	SB Brushed Brass		

MINIPOINT ORDER CODE

Model	Finish
770-M-A-DC	-
	WH White RAL 9010
	EBA Black RAL 9005
	AL Brushed Aluminium
	RB Rubbed Bronze
	PB Polished Brass
	SB Brushed Brass

Example Code: 1005-E-WH-309523

*Premium & custom finishes are built to order, subject to an extended lead time & MOQ
See Drivers, Power Supplies and Accessories sections for further order codes

Example Code: 770-M-A-DC-WH

STACKO STRAIGHT FIXED END

45° FLOOD BEAM

STATIC WHITE

OVERVIEW

Stacko Straight Fixed End is a Constant Current miniature display lighting product. It has four beam distributions and is a part of the modular Stacko Collection allowing users to 'stack' products together to create unique lighting set-ups that comes as standard in white, black and brushed aluminium. There are 5 light engines totalling 510lm | 5.60W. Each flood beam in our 102lm light engine has a peak intensity of 109cd. This 'End' module closes the circuit and does not accept further modules. There can only be a maximum of 10 light engines per Stacko circuit or driver. The luminaire is compatible with our Minipoint system that enables a plug and play setup where luminaires can be swapped to suit changing lighting requirements.



UK PART L	Part L1A / L1B (Dwellings)	EXEMPT
	Part L2A (General)	EXEMPT
	Part L2A (Display)	EXEMPT



PERFORMANCE

FWHM	45°	Category	IP20
Luminous Flux	Total: 465 lm Per Light Engine: 93 lm	Material	Machined AL 6063-T6 Machined Brass
Light Engines	5	Finishes	Brushed Aluminium White RAL9010 Matte Black Anodised Rubbed Bronze* Polished Brass* Brushed Brass * Polished Nickel*
CCT	2700K 3000K	Weight	79g 0.17lb
CRI Min.	95 TYP	Mounting	Minipoints
Drive Current	350 mA	Movement	Pan 360° Tilt N/A
Nom. Voltage	16 V	Lockable	N/A
Max. Wattage	5.60 W	Accessories	N/A N/A
Dimming	0-10V DALI	TM65 TM66	8.1kgCO2e 2.4
Driver Type	Constant Current Remote	Lifetime	L90B10 100,000hrs 5 year warranty
Class	SELV Class III		

DIMENSIONS

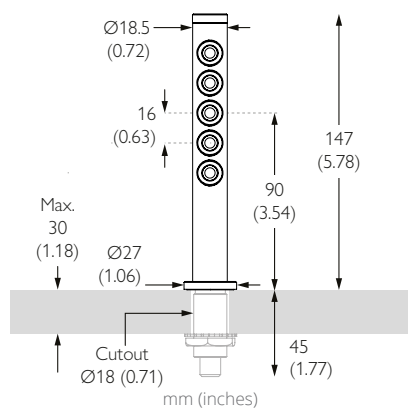

PHOTOMETRY

CCT	Multiplier
2700K	x1.00
3000K	x1.00

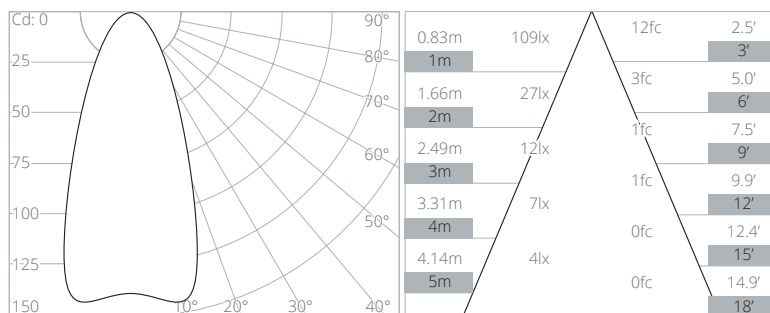

Data at 3000K, Single Light Engine

LUMINAIRE ORDER CODE

Model	Finish	CCT	Beam Angle
1005-E	-	-	-
	WH White RAL 9010	2795 2700K 95CRI	16 Narrow
	EBA Black RAL 9005	3095 3000K 95CRI	23 Medium
	AL Brushed Aluminium		45 Flood
	RB Rubbed Bronze		90 Wide Flood
	PB Polished Brass		
	SB Brushed Brass		

MINIPOINT ORDER CODE

Model	Finish
770-M-A-DC	-
	WH White RAL 9010
	EBA Black RAL 9005
	AL Brushed Aluminium
	RB Rubbed Bronze
	PB Polished Brass
	SB Brushed Brass

Example Code: 1005-E-WH-30954S

*Premium & custom finishes are built to order, subject to an extended lead time & MOQ
See Drivers, Power Supplies and Accessories sections for further order codes

Example Code: 770-M-A-DC-WH

STACKO STRAIGHT FIXED END

90° WIDE FLOOD BEAM

STATIC WHITE

OVERVIEW

Stacko Straight Fixed End is a Constant Current miniature display lighting product. It has four beam distributions and is a part of the modular Stacko Collection allowing users to 'stack' products together to create unique lighting set-ups that comes as standard in white, black and brushed aluminium. There are 5 light engines totalling 510lm | 5.60W. Each wide flood beam in our 102lm light engine has a peak intensity of 26cd. This 'End' module closes the circuit and does not accept further modules. There can only be a maximum of 10 light engines per Stacko circuit or driver. The luminaire is compatible with our Minipoint system that enables a plug and play setup where luminaires can be swapped to suit changing lighting requirements.



UK PART L	Part L1A / L1B (Dwellings)	EXEMPT
	Part L2A (General)	EXEMPT
	Part L2A (Display)	EXEMPT



PERFORMANCE

FWHM	90°	Category	IP20
Luminous Flux	Total: 345 lm Per Light Engine: 69 lm	Material	Machined AL 6063-T6 Machined Brass
Light Engines	5	Finishes	Brushed Aluminium White RAL9010 Matte Black Anodised Rubbed Bronze* Polished Brass* Brushed Brass * Polished Nickel*
CCT	2700K 3000K	Weight	79g 0.17lb
CRI Min.	95 TYP	Mounting	Minipoints
Drive Current	350 mA	Movement	Pan 360° Tilt N/A
Nom. Voltage	16 V	Lockable	N/A
Max. Wattage	5.60 W	Accessories	N/A N/A
Dimming	0-10V DALI	TM65 TM66	8.1kgCO2e 2.4
Driver Type	Constant Current Remote	Lifetime	L90B10 100,000hrs 5 year warranty
Class	SELV Class III		

DIMENSIONS

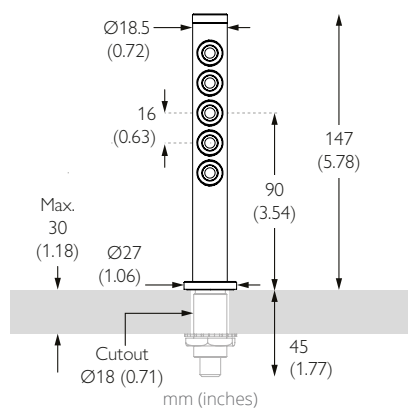

PHOTOMETRY

CCT	Multiplier
2700K	x1.00
3000K	x1.00

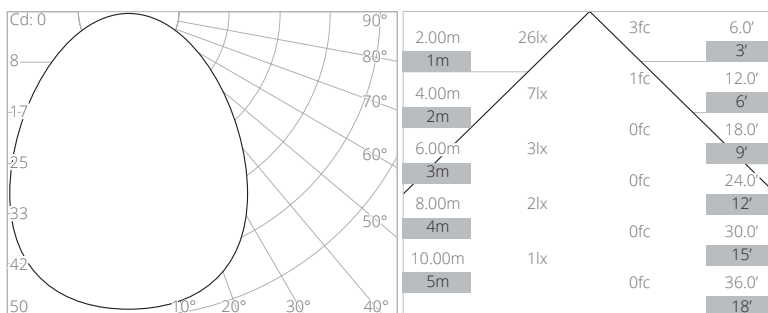

Data at 3000K, Single Light Engine

LUMINAIRE ORDER CODE

Model	Finish	CCT	Beam Angle
1005-E	-	-	-
	WH White RAL 9010	2795 2700K 95CRI	16 Narrow
	EBA Black RAL 9005	3095 3000K 95CRI	23 Medium
	AL Brushed Aluminium		45 Flood
	RB Rubbed Bronze		90 Wide Flood
	PB Polished Brass		
	SB Brushed Brass		

MINIPOINT ORDER CODE

Model	Finish
770-M-A-DC	-
	WH White RAL 9010
	EBA Black RAL 9005
	AL Brushed Aluminium
	RB Rubbed Bronze
	PB Polished Brass
	SB Brushed Brass

Example Code: 1005-E-WH-309590

*Premium & custom finishes are built to order, subject to an extended lead time & MOQ
See Drivers, Power Supplies and Accessories sections for further order codes

Example Code: 770-M-A-DC-WH

DRIVERS

NO. OF LIGHTS PER DRIVER

Stacko has a varying number of light engines per product. There can only be a maximum of 10 light engines per Stacko circuit or driver. The Stacko range is compatible with our Minipoint system that enables a plug and play setup where luminaires can be swapped to suit changing lighting requirements.

Stacko Tilt Fixed End	3 Light engines
Stacko Tilt Fixed Mid	3 Light engines
Stacko Straight Fixed End	5 Light engines
Stacko Straight Fixed Mid	5 Light engines
Stacko Multi-Aim 3 End	3 Light engines
Stacko Multi-Aim 3 Mid	3 Light engines
Stacko Aim End	1 Light engine
Stacko Aim Mid	1 Light engine

30W | DIMMING: DALI OR 0-10V

NO. OF LIGHT ENGINES PER DRIVER 1 to 10 light engines

MIN DIM LEVEL 0.1%

VOLTAGE REGION 230V

FOR NORTH AMERICA No

WATTAGE 30W

SUPPLY TYPE Constant Current

DRIVER LOCATION Remote

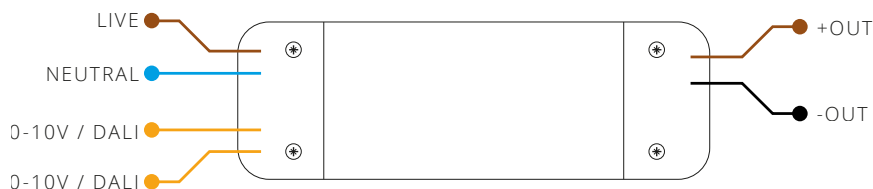

DALI CODE PSCC-30-350-D-EL-ENC

0-10V CODE PSCC-30-350-A-EL-ENC

LENGTH 210mm (8.3")

WIDTH 41mm (1.6")

HEIGHT 34mm (1.3")



30W | DIMMING: DALI OR 0-10V

NO. OF LIGHT ENGINES PER DRIVER 1 to 10 light engines

MIN DIM LEVEL 0.1%

VOLTAGE REGION 120V

FOR NORTH AMERICA Yes

WATTAGE 30W

SUPPLY TYPE Constant Current

DRIVER LOCATION Remote



DALI CODE USCC-30-350-D-EL-ENC

0-10V CODE USCC-30-350-A-EL-ENC

LENGTH 348mm (13.7")

WIDTH 65mm (2.6")

HEIGHT 47mm (1.9")



MINIPOINT JACK SYSTEM

MOUNTING OPTIONS

MOUNTING OPTIONS

NODE MINIPOINT

For mounting into cabinetry

MINIPOINT CODE	FINISH
770-M-A-DC-AL	Brushed Aluminium
770-M-A-DC-WH	White RAL 9010
770-M-A-DC-EBA	Black RAL 9005
770-M-A-DC-AL	Rubbed Bronze
770-M-A-DC-AL	Polished Brass
770-M-A-DC-AL	Brushed Brass

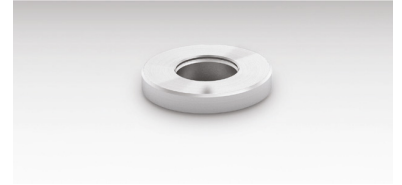
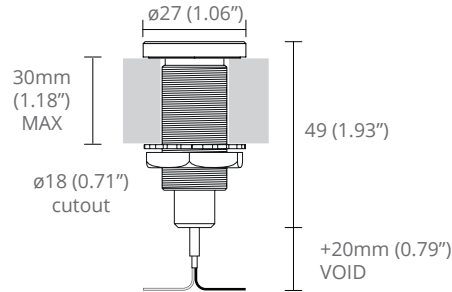

MINIPOINT PLUG

For closing an open circuit / unused minipoint

MINIPOINT CODE	FINISH
770-BPA-AL	Brushed Aluminium
770-BPA-WH	White RAL 9010
770-BPA-EBA	Black RAL 9005
770-BPA-RB	Rubbed Bronze
770-BPA-PB	Polished Brass
770-BPA-SB	Brushed Brass

