

# Installation Instructions - Plexineon Surface Dynamic Color

Models: Plexineon Fixture Surface Mount Dynamic Color and Plexineon Rings Surface Mount Dynamic Color

**Please read all instructions prior to installation and keep for future reference!**

1. PRODUCT TO BE INSTALLED BY A QUALIFIED ELECTRICIAN.
2. USE ONLY WITH CLASS 2 POWER UNIT
3. 24 VOLTS DC
4. SUITABLE FOR WET LOCATIONS
5. SURFACE MOUNT ONLY



REVO.1  
12092024

1 / 5

**ilight**  
by luminii  
7777 Merrimac Ave  
Niles, IL 60714  
T 224.333.6033  
F 224.757.7557  
info@luminii.com  
www.luminii.com



Plexineon Straight Run Fixture

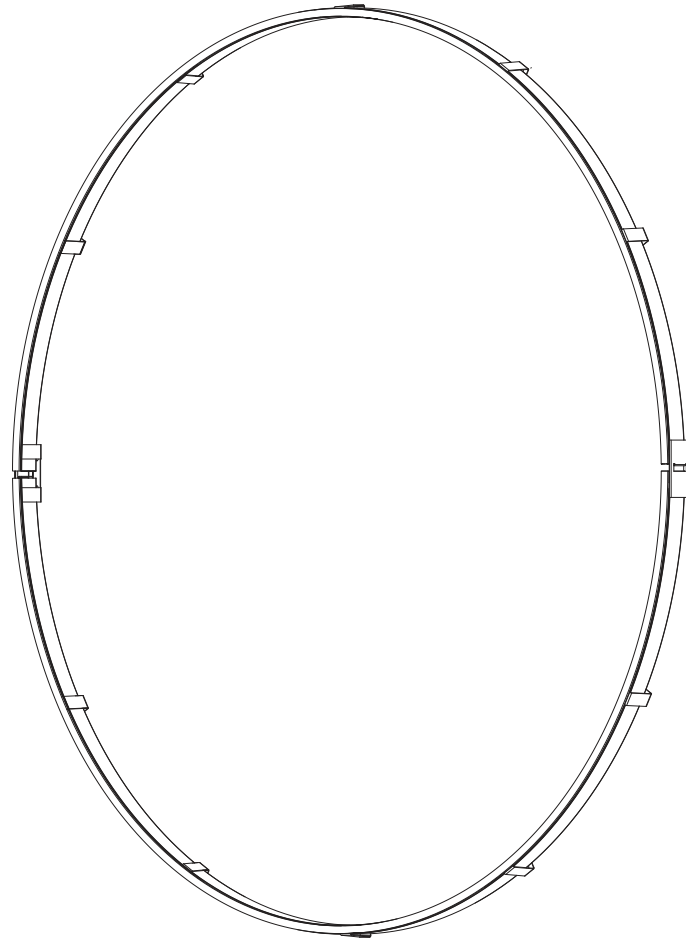

Plexineon Ring Surface Mount

# Installation Instructions - Plexineon Surface Dynamic Color

Models: Plexineon Fixture Surface Mount Dynamic Color and Plexineon Rings Surface Mount Dynamic Color

Please read all instructions prior to installation and keep for future reference!

1. PRODUCT TO BE INSTALLED BY A QUALIFIED ELECTRICIAN.
2. USE ONLY WITH CLASS 2 POWER UNIT
3. 24 VOLTS DC
4. SUITABLE FOR WET LOCATIONS
5. SURFACE MOUNT ONLY



REVO.1  
12092024

2 / 5

**ilight**  
by luminii  
7777 Merrimac Ave  
Niles, IL 60714  
T 224.333.6033  
F 224.757.7557  
info@luminii.com  
www.luminii.com

**1**

**NOTE:** Prior to installation all 24VDC wires must be present within 72" of the installation. Refer to the power supply installation instruction for additional information.

**NOTE:** More than one person is recommended for this installation.

**1.1** Once the location or pattern is determined for Plexineon to be installed, start off by marking the area. Amount of mounting clips may vary dependant upon pattern. Reference diagrams below.

## Straight run with mounting clips

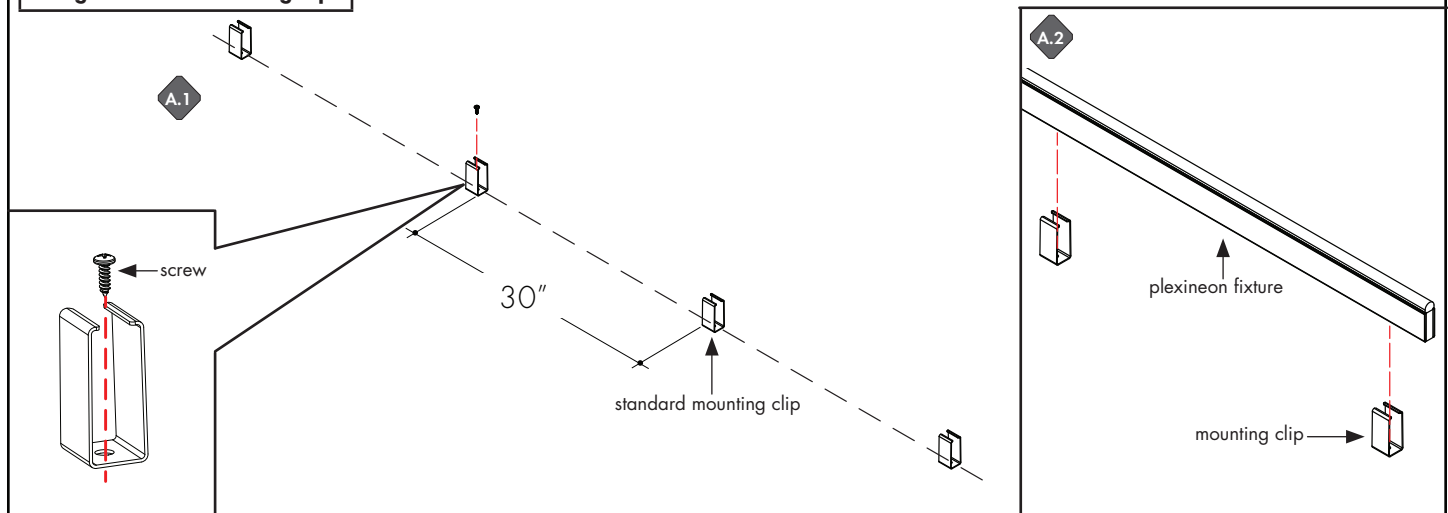

**A.1** Line up and screw on the mounting clips to the mounting holes with no greater than 30" apart. Make sure it is straight by using a level.

**A.2** Fix the plexineon fixture into installed mounting clips. See page 3 for clipping instructions.

## Curved run/rings with mounting clips

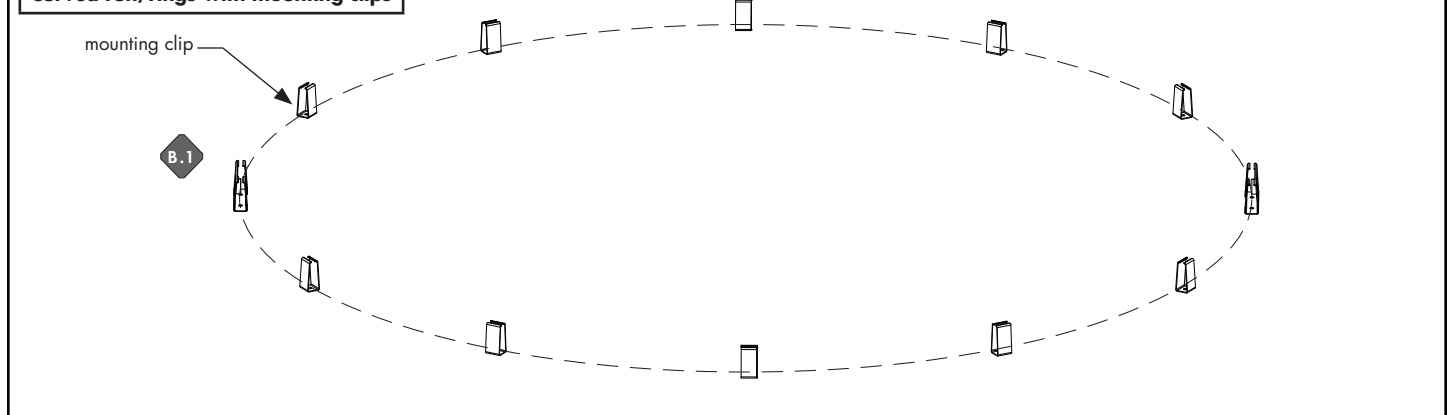

**B.1** Determine the shape of the plexineon layout, then mark the pattern onto the surface. Place the mounting clips with no greater than 30" apart. Screw onto surface.

**B.2** Fix the plexineon bend/ring fixture into installed mounting clips. See page 3 for clipping instructions.

**NOTE:** Standard Clips and Decorative Clips have different required spacing.

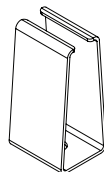

← standard mounting clip  
30" space



← decorative mounting clip  
18" space

# Installation Instructions - Plexineon Surface Dynamic Color

Models: Plexineon Fixture Surface Mount Dynamic Color and Plexineon Rings Surface Mount Dynamic Color

Please read all instructions prior to installation and keep for future reference!

1. PRODUCT TO BE INSTALLED BY A QUALIFIED ELECTRICIAN.
2. USE ONLY WITH CLASS 2 POWER UNIT
3. 24 VOLTS DC
4. SUITABLE FOR WET LOCATIONS
5. SURFACE MOUNT ONLY



REVO.1  
12092024

3 / 5

**ilight**  
by luminii  
7777 Merrimac Ave  
Niles, IL 60714  
T 224.333.6033  
F 224.757.7557  
info@luminii.com  
www.luminii.com

### Install Fixtures into Mounting Clips

**C.1** Make an U shape with mounting clip installation tool, insert two edges into mounting clip. Place plexineon fixture inside the shape. Then push the fixture into clip.

**C.2** Remove the tool. Make sure mounting clip is clipped right on the grip.

## Power Supply Wiring Diagram

**Note:** Prior to installation all 24VDC wires must be present near fixture. Refer to the power supply installation instructions for additional information.



RGB/RGBW  
Wiring Diagram PDF

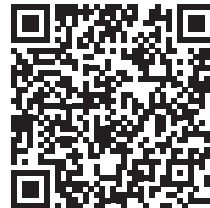

Pixel  
Wiring Diagram PDF

# Installation Instructions - Plexineon Surface Dynamic Color

Models: Plexineon Fixture Surface Mount Dynamic Color and Plexineon Rings Surface Mount Dynamic Color

Please read all instructions prior to installation and keep for future reference!

1. PRODUCT TO BE INSTALLED BY A QUALIFIED ELECTRICIAN.
2. USE ONLY WITH CLASS 2 POWER UNIT
3. 24 VOLTS DC
4. SUITABLE FOR WET LOCATIONS
5. SURFACE MOUNT ONLY



REVO.1  
12092024

4 / 5

**ilight**  
by luminii  
7777 Merrimac Ave  
Niles, IL 60714  
T 224.333.6033  
F 224.757.7557  
info@luminii.com  
www.luminii.com

## WIRING DIAGRAM

### SR-DMX-SPI

Smart Pixel LineLED Decoder

**NOTE:** Please make sure that power is turned off before wiring.

Also, ensure that the correct power supply (voltage and wattage) is used to power the LED strips connected to the decoder. Follow illustrated wiring diagram. Use screwdriver to open and close connection slots.

**NOTE:** When connecting two or more LED strip lights or light fixtures, always make sure the signal direction arrows are pointing to same direction

The signal direction arrow should appear on label of each section of LED fixture.

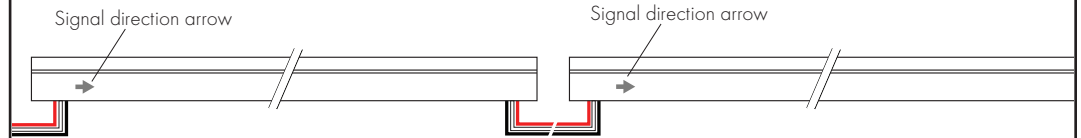

**NOTE:** Must power from the opposite direction of the signal direction arrow

120 ohms  
Terminator for the  
DMX decoder\*

### CONTROLLER WIRES

100 ft max,  
decoder to Controller  
provided by others

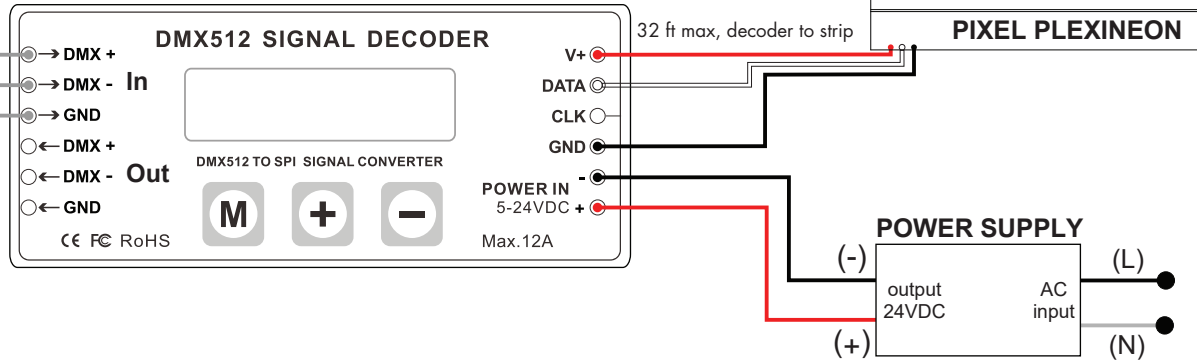

# Installation Instructions - Plexineon Surface Dynamic Color

Models: Plexineon Fixture Surface Mount Dynamic Color and Plexineon Rings Surface Mount Dynamic Color

Please read all instructions prior to installation and keep for future reference!

1. PRODUCT TO BE INSTALLED BY A QUALIFIED ELECTRICIAN.
2. USE ONLY WITH CLASS 2 POWER UNIT
3. 24 VOLTS DC
4. SUITABLE FOR WET LOCATIONS
5. SURFACE MOUNT ONLY



REVO.1  
12092024

5 / 5

**ilight**  
by luminii  
7777 Merrimac Ave  
Niles, IL 60714  
T 224.333.6033  
F 224.757.7557  
info@luminii.com  
www.luminii.com

## OPERATING GUIDE

### SR-DMX-SPI

Smart Pixel LineLED Decoder

There are three buttons on the decoder.



Parameter Setting



Increase Value



Decrease Value

After operation, if no action was taken within 30s, the button lock, and backlight of the screen will turn off.

1. Long press M button for 5s to unlock the buttons, and the backlight will turn on.
2. Long press M button for 5s to switch between test mode and decode mode after unlocked. During test mode, the first line of LCD will show: TEST MODE. Use test mode to verify RGBW Pixel functionality. During decoder mode, the first line of LCD shows: DECODER MODE. Use decoder mode when connecting to Controller and for final installation and customization.

The second line of the LCD Display shows the current setting and value. Note: 1 Pixel = 1 Cut Increment

### MODE TABLE

SETTING	LCD DISPLAY	VALUE RANGE	DESCRIPTION
Built-in Programs	TEST MODE MODE NO.:	1-26	See Program Table below
Program Speed	TEST MODE RUN SPEED:	0-7	0: fast, 7: slow
DMX Address	DECODER MODE DMX ADDRESS:	1-512	Address of the starting point/Pixel of a program
DMX Signal RGB	DECODER MODE DMX RGB SEQ:	RGB, BGR, etc.	N/A
Pixel Quantity	DECODER MODE PIXEL QTY:	1-170(RGB), 1-128(RGBW)	Number of Pixels to follow a program
IC TYPE	DECODER MODE IC TYPE:	2903, 8903, 2904, 8904	2903: N/A, 2904: for RGBW, 8903: N/A, 8904: N/A
Color	DECODER MODE COLOR:	MONO, DUAL, RGB, RGBW	MONO: N/A, DUAL: N/A, RGB: N/A, RGBW: for RGBW
Pixel Merging / Pixel Size	DECODER MODE PIXEL MERGE:	1-100	Number of Pixels to merge together
RGB Sequence	DECODER MODE LED RGB SEQ:	RGBW, BGRW, etc.	Sequence of RGBW, 24 possible combinations
Integral Control	DECODER MODE ALL CONTROL:	YES, NO	Yes: Merge all Pixels No: Maintain individual Pixels or Merged Pixels
Reverse Control	DECODER MODE REV-CONTROL:	YES, NO	Reverse program order
Overall Brightness	DECODER MODE BRIGHTNESS:	1-100	1: dimmest setting 100: brightest setting

### NOTE:

When connected to a controller, DMX512 Signal Decoder will stay in "Decoder Mode".

### NOTE:

The actual maximum control pixels of the controller are 1360 (2903) ,1024 (2904). Please set the pixel and pixel combination value according to the actual situation, and DO NOT exceed the maximum.

### NOTE:

For Program Table Change: no fading/dimming between color changes  
Fade: fade/dim between color changes  
Chase: change pixel by pixel  
Chase with Trail: change pixel by pixel with fading between

### PROGRAM TABLE

PROGRAM NO.	PROGRAM DESCRIPTION	PROGRAM NO.	PROGRAM DESCRIPTION	PROGRAM NO.	PROGRAM DESCRIPTION
1	Solid color: Red	10	RGB fading	19	Red chasing green, chasing blue
2	Solid color: Green	11	Full color fading	20	Orange chasing purple, chasing cyan
3	Solid color: Blue	12	Red chase with trail	21	Rainbow chase (7 colors)
4	Solid color: Yellow	13	Green chase with trail	22	Random twinkle: white over red
5	Solid color: Purple	14	Blue chase with trail	23	Random twinkle: white over green
6	Solid color: Cyan	15	White chase with trail	24	Random twinkle: white over blue
7	Solid color: White	16	RGB chase with trail	25	White fading
8	RGB change	17	Rainbow chase with trail	26	Off
9	Full color change	18	RGB chasing and fading		