

# 0-10V Warm Dim 96 Watt LED Driver - Installation Instructions

Models PS-010V-WD-D-96-24

Please read all instructions prior to installation and keep for future reference!

THIS LED DRIVER IS TO BE INSTALLED IN ACCORDANCE WITH ARTICLE 450 OF THE NATIONAL ELECTRICAL CODE. THE LED DRIVER MUST BE INSTALLED IN A WELL VENTILATED AREA AND FREE FROM EXPLOSIVE GASES AND VAPORS. PROPER OPERATION REQUIRES THE FREE FLOW OF AIR. AS THIS LED DRIVER IS HARDWIRED, IT SHOULD ONLY BE INSTALLED BY A QUALIFIED ELECTRICIAN. SUITABLE FOR DAMP LOCATION.



7777 Merrimac Ave  
Niles, IL 60714  
T 224.333.6033  
F 224.757.7557  
info@luminii.com  
www.luminii.com

PLENUM FOR SUCH USE IN ACCORDANCE WITH UL2043

REV.0.2  
09192024

1 / 5

Input	120 - 277 V AC, 1.1 A, 50/60 Hz
Output	24 V DC, 4.0 A
Max. Wattage	96 W

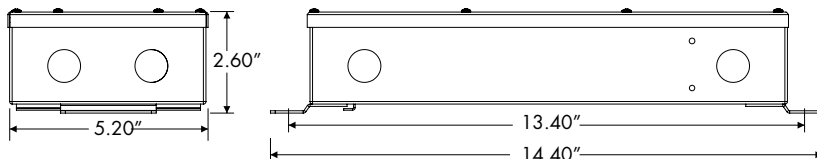

**1**

Before installing, check the label and ensure the LED Driver has the proper input voltage, output voltage, and wattage for the job. Check the wire markings to ensure they match the wiring diagram below. Refer to table above for the maximum loads!

**1.1** LED Driver can be mounted vertically or horizontally. With a minimum of 3" clearance around LED Driver to provide proper air circulation.

**2**

**2.1** Remove the cover from top of the driver housing to expose the driver wires. Screws for cover will be found inside the housing.

**3**

DIM.010.W3 0 - 10VDC CONTROL  
DIMMING RANGE: 0-100% CLASS 2  
LED DIM MODULE DRY & DAMP  
LOCATIONS (10 - 30VDC-5A - 1Khz) **PS-010V-WD-D-96-24**

**3.1** Connect the 120-277V AV power into the housing from the electrical panel. Followed by connecting the 24V DC low voltage conduit, one for the LED and other for the controller wires. Refer to the diagram below to make all the proper wiring connections.

# 0-10V Warm Dim 96 Watt LED Driver - Installation Instructions

Models PS-010V-WD-D-96-24

**Please read all instructions prior to installation and keep for future reference!**

THIS LED DRIVER IS TO BE INSTALLED IN ACCORDANCE WITH ARTICLE 450 OF THE NATIONAL ELECTRICAL CODE. THE LED DRIVER MUST BE INSTALLED IN A WELL VENTILATED AREA AND FREE FROM EXPLOSIVE GASES AND VAPORS. PROPER OPERATION REQUIRES THE FREE FLOW OF AIR. AS THIS LED DRIVER IS HARDWIRED, IT SHOULD ONLY BE INSTALLED BY A QUALIFIED ELECTRICIAN. SUITABLE FOR DAMP LOCATION.

PLENUM FOR  
SUCH USE IN  
ACCORDANCE  
WITH UL2043



REVO.2  
09192024

2 / 5



7777 Merrimac Ave  
Niles, IL 60714  
T 224.333.6033  
F 224.757.7557  
info@luminii.com  
www.luminii.com

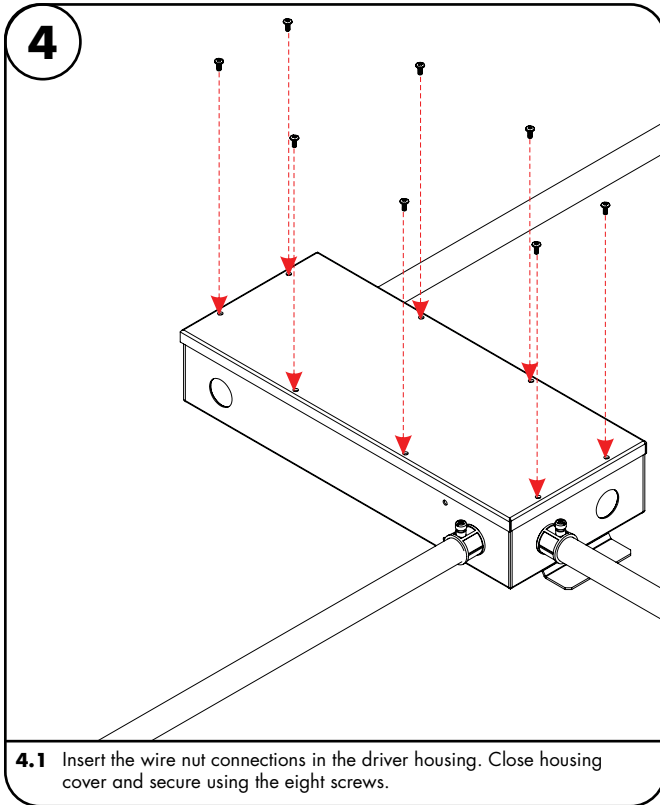

**4.1** Insert the wire nut connections in the driver housing. Close housing cover and secure using the eight screws.

# 0-10V Warm Dim 96 Watt LED Driver - Installation Instructions

Models PS-010V-WD-D-96-24



7777 Merrimac Ave  
Niles, IL 60714  
T 224.333.6033  
F 224.757.7557  
info@luminii.com  
www.luminii.com

**Please read all instructions prior to installation and keep for future reference!**

THIS LED DRIVER IS TO BE INSTALLED IN ACCORDANCE WITH ARTICLE 450 OF THE NATIONAL ELECTRICAL CODE. THE LED DRIVER MUST BE INSTALLED IN A WELL VENTILATED AREA AND FREE FROM EXPLOSIVE GASES AND VAPORS. PROPER OPERATION REQUIRES THE FREE FLOW OF AIR. AS THIS LED DRIVER IS HARDWIRED, IT SHOULD ONLY BE INSTALLED BY A QUALIFIED ELECTRICIAN. SUITABLE FOR DAMP LOCATION.

PLENUM FOR SUCH USE IN ACCORDANCE WITH UL2043

REVO.2  
09192024

3 / 5

## User Guide Instructions

1

1.1 Download VintageDim® App from [Google Play Store](#) for Android OS or [Apple App Store](#) for iOS.

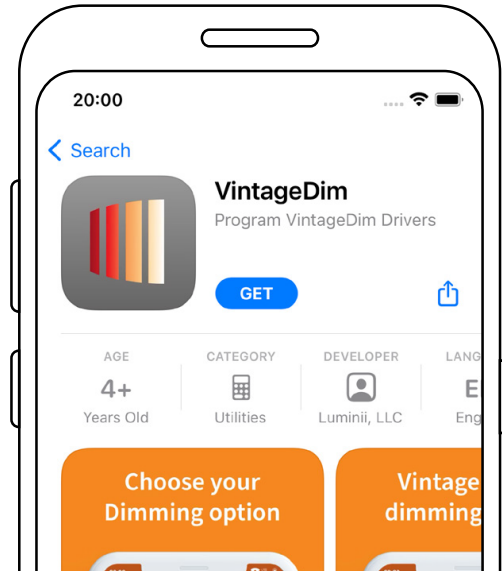
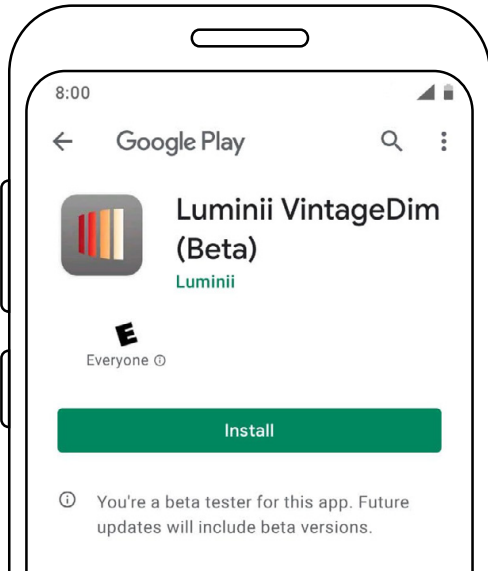

2

2.1 Open the App and choose one of the factory pre-build presets.

1. VintageDim® Warm Dim (page 2)

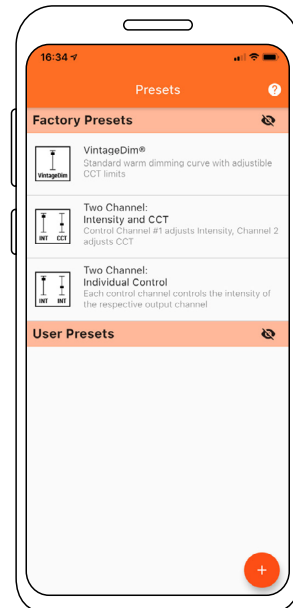

# 0-10V Warm Dim 96 Watt LED Driver - Installation Instructions

Models PS-010V-WD-D-96-24



7777 Merrimac Ave  
Niles, IL 60714  
T 224.333.6033  
F 224.757.7557  
info@luminii.com  
www.luminii.com

PLENUM FOR SUCH USE IN ACCORDANCE WITH UL2043

REVO.2  
09192024

4 / 5

## Using the App

3

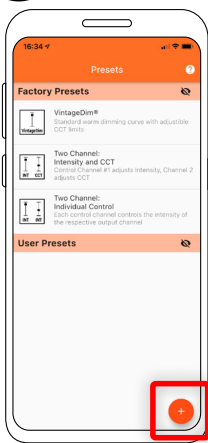

3.1 Select "Create New Preset" button.

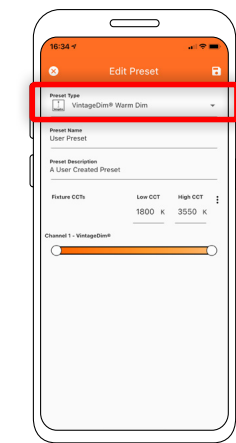

3.2 Select VintageDim® preset type.

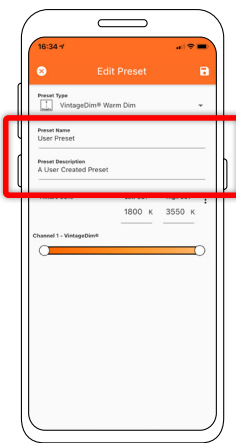

3.3 Change the preset name and description to your own.

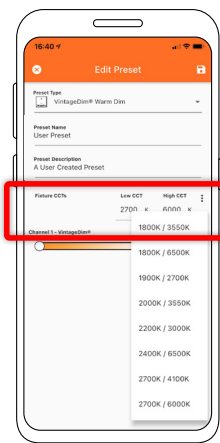

3.4 Set the CCT values of your light source or choose from preset Fixture CCTs option.

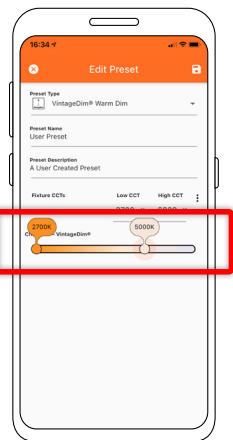

3.5 Adjust sliders for maximum and minimum CCT at the bottom of the screen. This calculates the correct curve using the values you set in this section.

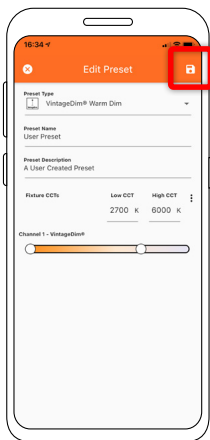

3.6 Save preset.

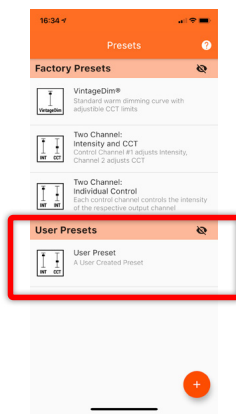

3.7 Select your new user preset from the main list.

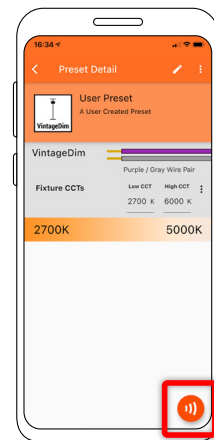

3.8 Press Program button.

3.9 Place phone directly on the VintageDim® module. Phone will play a tone when programming begins. Programming is complete when you hear a single beep and see the "Programming Successful" screen.

If the driver was off during programming, simply power on and the driver will work according to the new program. If the driver was on during programming, it will need to be power cycled for new programming to become active.

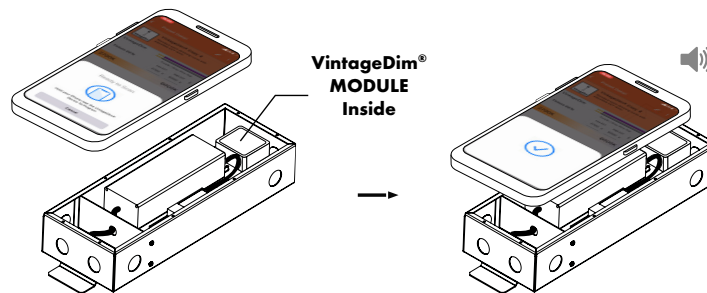

\* Lid of driver case must be removed.

# 0-10V Warm Dim 96 Watt LED Driver - Installation Instructions

Models PS-010V-WD-D-96-24



7777 Merrimac Ave  
Niles, IL 60714  
T 224.333.6033  
F 224.757.7557  
info@luminii.com  
www.luminii.com

Please read all instructions prior to installation and keep for future reference!

THIS LED DRIVER IS TO BE INSTALLED IN ACCORDANCE WITH ARTICLE 450 OF THE NATIONAL ELECTRICAL CODE. THE LED DRIVER MUST BE INSTALLED IN A WELL VENTILATED AREA AND FREE FROM EXPLOSIVE GASES AND VAPORS. PROPER OPERATION REQUIRES THE FREE FLOW OF AIR. AS THIS LED DRIVER IS HARDWIRED, IT SHOULD ONLY BE INSTALLED BY A QUALIFIED ELECTRICIAN. SUITABLE FOR DAMP LOCATION.

PLENUM FOR SUCH USE IN ACCORDANCE WITH UL2043

REV.0.2  
09192024

5 / 5

## Using the App

4

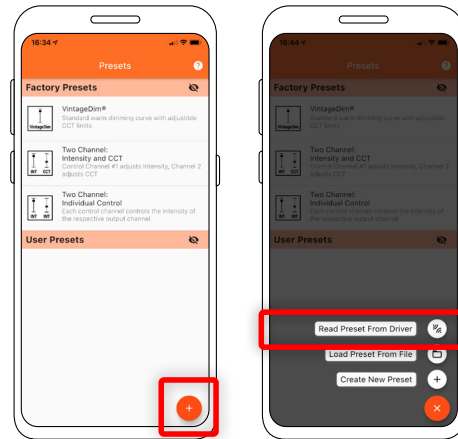

4.1 Select Read Preset From Driver button.

4.2 Place phone directly on the VintageDim® module. Reading is complete when you see the following confirmation on screen.

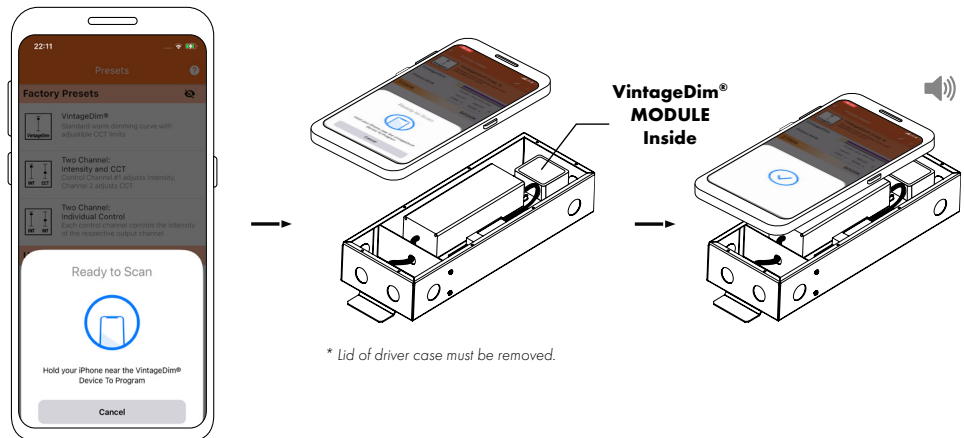

4.3 After successful reading you will see new user preset created with corresponding name and description.

