

MINIMO PRO

WITH PRECISION INTENSE LIGHT ENGINE



KEY FEATURES

- Fixed or 35° adjustable tilt
- Tool-less site changeable optics
- High power single source light engine
- High CRI
- Beveled or Pinhole aesthetic
- Trimmed or Trimless

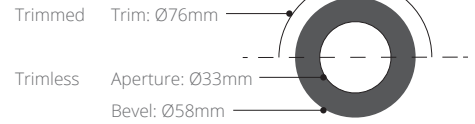

Minimo Pro features the Precision Intense light engine: Precision Intense offers specifiers a high CRI single source beam focused on delivering high peak cd with narrow beams. This is a constant current downlight machined from aerospace grade aluminum 6063-T6 and comes with a range of standard and premium finishes. It has five tool-less site changeable optics for flexible beam distribution. Minimo Pro has up to 35° tilt whilst the integral accessory holder can accommodate a lens or louvre for additional glare control.

PERFORMANCE DATA

DELIVERED OUTPUT	660lm (at 3000K)	WATTAGE	8.4W
BEAM ANGLES	11° 14° 18° 30° 50°	ELECTRICAL	12V 700mA
CCT	2700K 3000K 4000K (custom option)	DRIVER LOCATION	Remote
CRI	92TYP - 2700K/3000K	REMOTE DRIVERS	DALI 0-10V
TM-30	R9: 61 RF: 90 RG: 99 (at 3000K)	ACCESSORIES	Louwer Lenses
BINNING	2 SDCM	ACCESSORY HOLDER	Integral
LIFETIME	L90 50,000 hrs min	TM65	13.09kgCO2e
WARRANTY	5 Years	TM66	2.2

MECHANICAL & MOUNTING

LOCATION	IP20 IP54 available	MOUNTING	Recessed
ADJUSTABILITY	Fixed or 35° Tilt, 360° Rotation	CEILING THICKNESS	3-25mm
OPTICS	Site Changeable	CUTOUT	65mm
WEIGHT	250g	MIN VOID HEIGHT	110mm
MATERIAL	Machined AL 6063-T6		

BEVELED APERTURE ORDER CODE

TRIM TYPE	FUNCTION	TRIM FINISH	APERTURE FINISH	CCT	BEAM ANGLE
RCD- Trimmed RCT- Trimless	FIXED 631- IP20 633- IP54	X Trimless W White RAL9010 B Black RAL9005 A Brushed Aluminium R Rubbed Bronze ¹ P Polished Brass ¹ S Brushed Brass ¹ C Polished Chrome ¹	W- White RAL9010 B- Black RAL9005 G- Matt Gold Paint	2792 2700K 3092 3000K	UN Ultra Narrow 11°
					NA Narrow 14°
	ADJUSTABLE 635- IP20 637- IP54				ME Medium 18°
					FL Flood 30°
					WF Wide Flood 50°

PINHOLE APERTURE ORDER CODE

TRIM TYPE	FUNCTION	TRIM FINISH	APERTURE FINISH	CCT	BEAM ANGLE
RCD- Trimmed RCT- Trimless	FIXED 632- IP20 634- IP54	X Trimless W White RAL9010 B Black RAL9005	W- White RAL9010 B- Black RAL9005	2792 2700K 3092 3000K	UN Ultra Narrow 11°
					NA Narrow 14°
	ADJUSTABLE 636- IP20 638- IP54				ME Medium 18°
					FL Flood 30°
					WF Wide Flood 50°

¹: Premium & custom finishes are built to order, subject to an extended lead time.

Code example
RCD-635-BG-2792ME

DRIVER ORDER CODE

PSCC-20-700-A-EL 0-10V Dim 0.1%

PSCC-20-700-D-EL DALI Dim 0.1%

Need a dimming protocol not listed here?
Contact us for our extended range of driver options

MINIMO PRO

WITH PRECISION INTENSE LIGHT ENGINE

TRIM & APERTURE TYPES



TRIMMED
PINHOLE



TRIMLESS
PINHOLE



TRIMMED
BEVELED



TRIMLESS
BEVELED

TRIM FINISHES

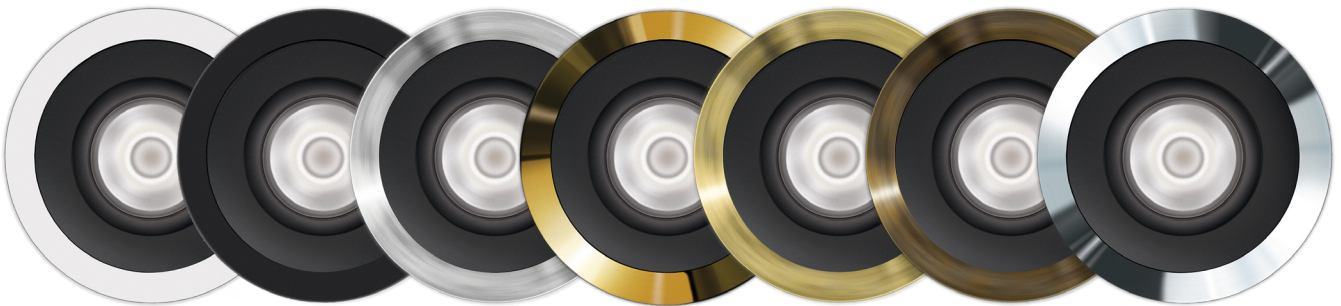

WHITE

BLACK

BRUSHED
ALUMINUM

POLISHED
BRASS

BRUSHED
BRASS

RUBBED
BRONZE

POLISHED
CHROME

APERTURE FINISHES

BEVELED

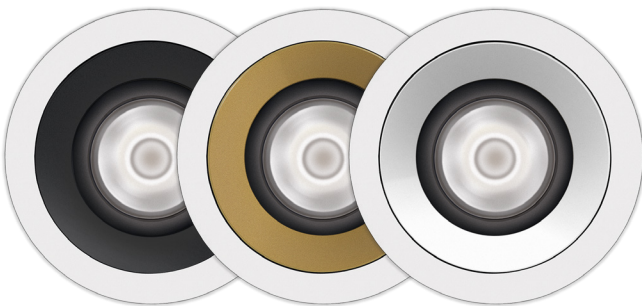

BLACK

MATTE GOLD

WHITE

PINHOLE



WHITE

BLACK

MINIMO PRO

WITH PRECISION INTENSE LIGHT ENGINE

DIMENSIONS

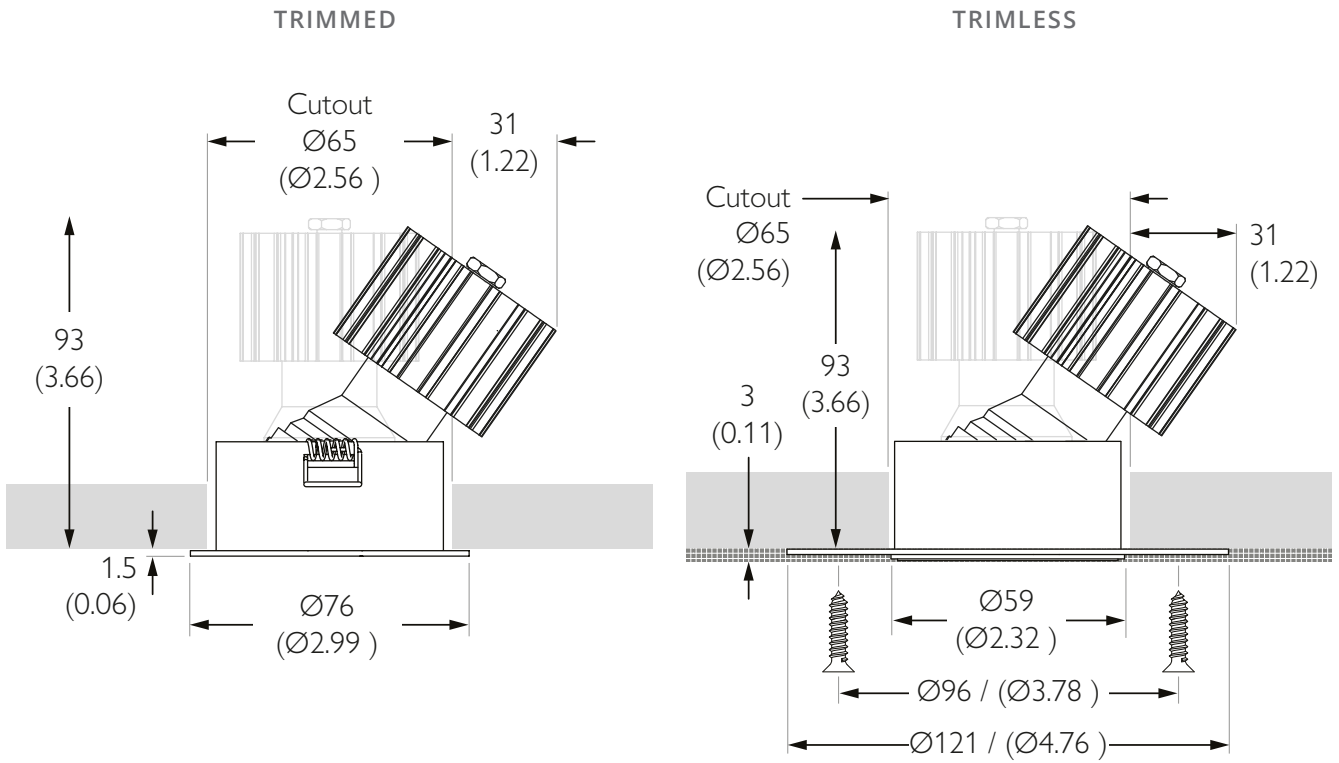

REMOTE DRIVER DETAIL

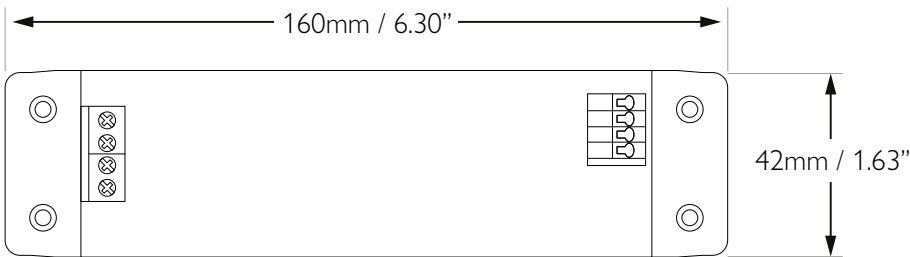

Dimming Type 0-10V
 Min Dim Level 0.1%
 Voltage In 230V
 Manufacturer Eldoled
 Code PSCC-20-700-A-EL

Dimming Type DALI
 Min Dim Level 0.1%
 Voltage In 230V
 Manufacturer Eldoled
 Code PSCC-20-700-D-EL

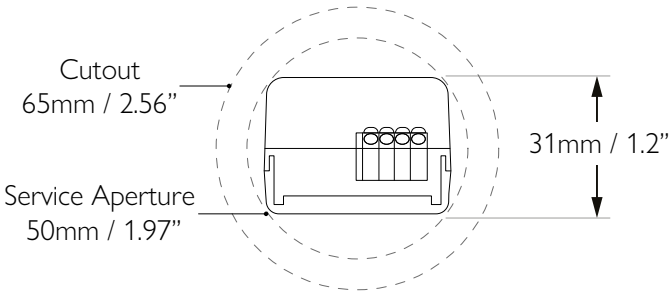

MINIMO PRO

WITH PRECISION INTENSE LIGHT ENGINE

OUTPUT SCALING

CCT	Multiplier	CRI	R9	Rf	Rg	Max Delivered lm
2400K	-	-	-	-	-	-
2700K	0.93	92	60	90	98	615lm
3000K	1.00	92	61	90	99	661lm
3500K	-	-	-	-	-	-
4000K	1.08	92	60	90	99	714lm

All diagrams and data measured at 3000K.

PHOTOMETRY

ULTRA NARROW BEAM

BEAM ANGLE 11°
DELIVERED LUMENS 661lm
UGR 13.0
PEAK INTENSITY 12512cd

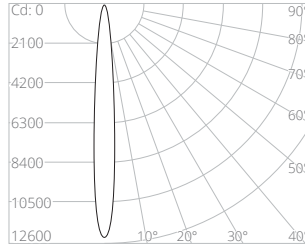
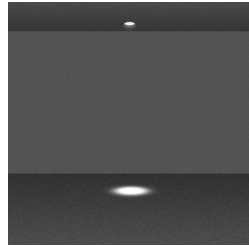

Height	Beam Diameter	Peak Intensity (lx)	Footcandle (fc)	Height (ft)	Beam Diameter (ft)
1m	0.19m	12512lx	1390fc	0.6ft	3ft
2m	0.39m	3128lx	348fc	1.2ft	6ft
3m	0.58m	1390lx	154fc	1.7ft	9ft
4m	0.77m	782lx	87fc	2.3ft	12ft
5m	0.96m	500lx	56fc	2.9ft	15ft
			39fc	3.5ft	18ft

NARROW BEAM

BEAM ANGLE 14°
DELIVERED LUMENS 650lm
UGR 13.30
PEAK INTENSITY 8971cd

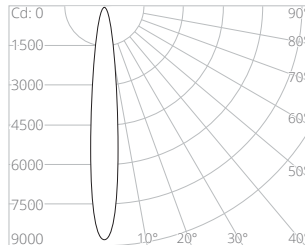
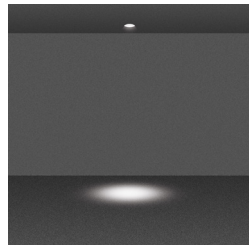

Height	Beam Diameter	Peak Intensity (lx)	Footcandle (fc)	Height (ft)	Beam Diameter (ft)
1m	0.25m	8971lx	997fc	0.7ft	3ft
2m	0.49m	2243lx	249fc	1.5ft	6ft
3m	0.74m	997lx	111fc	2.2ft	9ft
4m	0.98m	561lx	62fc	2.9ft	12ft
5m	1.23m	359lx	40fc	3.7ft	15ft
			28fc	4.4ft	18ft

MEDIUM BEAM

BEAM ANGLE 18°
DELIVERED LUMENS 643lm
UGR 13.70
PEAK INTENSITY 5754cd

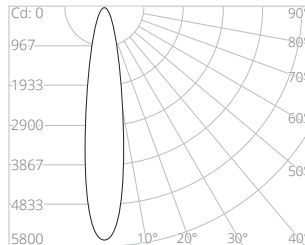
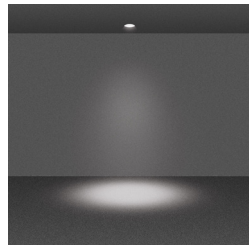

Height	Beam Diameter	Peak Intensity (lx)	Footcandle (fc)	Height (ft)	Beam Diameter (ft)
1m	0.32m	5754lx	639fc	1.0ft	3ft
2m	0.63m	1439lx	160fc	1.9ft	6ft
3m	0.95m	639lx	71fc	2.9ft	9ft
4m	1.27m	360lx	40fc	3.8ft	12ft
5m	1.58m	230lx	26fc	4.8ft	15ft
			18fc	5.7ft	18ft

FLOOD BEAM

BEAM ANGLE 30°
DELIVERED LUMENS 555lm
UGR 15.90
PEAK INTENSITY 1831cd

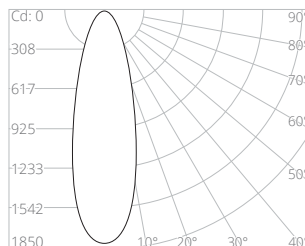
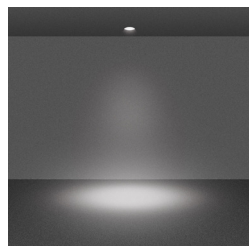

Height	Beam Diameter	Peak Intensity (lx)	Footcandle (fc)	Height (ft)	Beam Diameter (ft)
1m	0.54m	1813lx	201fc	1.6ft	3ft
2m	1.07m	453lx	50fc	3.2ft	6ft
3m	1.61m	201lx	22fc	4.8ft	9ft
4m	2.14m	113lx	13fc	6.4ft	12ft
5m	2.68m	73lx	8fc	8.0ft	15ft
			6fc	9.6ft	18ft

WIDE FLOOD BEAM

BEAM ANGLE 50°
DELIVERED LUMENS 546lm
UGR 20.50
PEAK INTENSITY 660cd

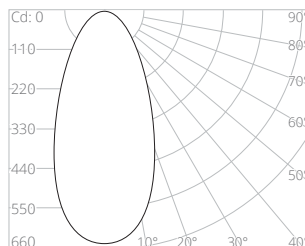
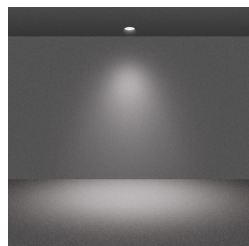

Height	Beam Diameter	Peak Intensity (lx)	Footcandle (fc)	Height (ft)	Beam Diameter (ft)
1m	0.93m	660lx	73fc	2.8ft	3ft
2m	1.87m	165lx	18fc	5.6ft	6ft
3m	2.80m	73lx	8fc	8.4ft	9ft
4m	3.73m	41lx	5fc	11.2ft	12ft
5m	4.66m	26lx	3fc	14.0ft	15ft
			2fc	16.8ft	18ft

MINIMO PRO

WITH PRECISION INTENSE LIGHT ENGINE

ACCESSORIES

The Minimo Pro can accommodate 1 accessory with no additional holder required as standard.

Honeycomb Louver

Enhances glare control

THICKNESS 3.2mm

DAIMETER 32mm

PART CODE 995-32-BK

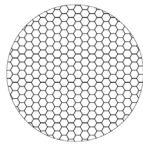

1/4 CTO Dichroic

CCT warming - approx 300K

THICKNESS 1.8mm

DAIMETER 32mm

PART CODE 997-1/4CTO-32



LUMINAIRE MODULE DETAILS

