

**Features**

The MK45V Channel is a linear aluminum extrusion that has been designed to fit many LED lighting needs and specifically corner applications. Multiple configuration options allow for great flexibility in any installation. Its small extrusion profile allows for more discreet integration into architectural elements, enabling a subtler, more refined aesthetic in both commercial and residential settings. MK45V Channel comes with multiple choices of diffuser lenses. Extrusion and lenses are field cuttable. Channels come with specified Mounting Clips and End Caps.

**Finish**  
Silver anodized, White, Black, Bronze

**Mounting**  
Concealed Bracket

**Diffuser Lens**  
Polycarbonate, snap-in-place, UV resistant

**Warranty**  
7 Years

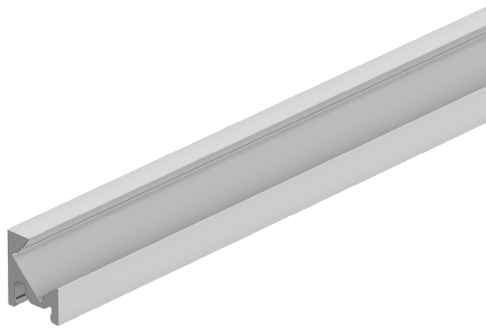

Declare. MADE IN U.S.A.

**Product Dimensions**

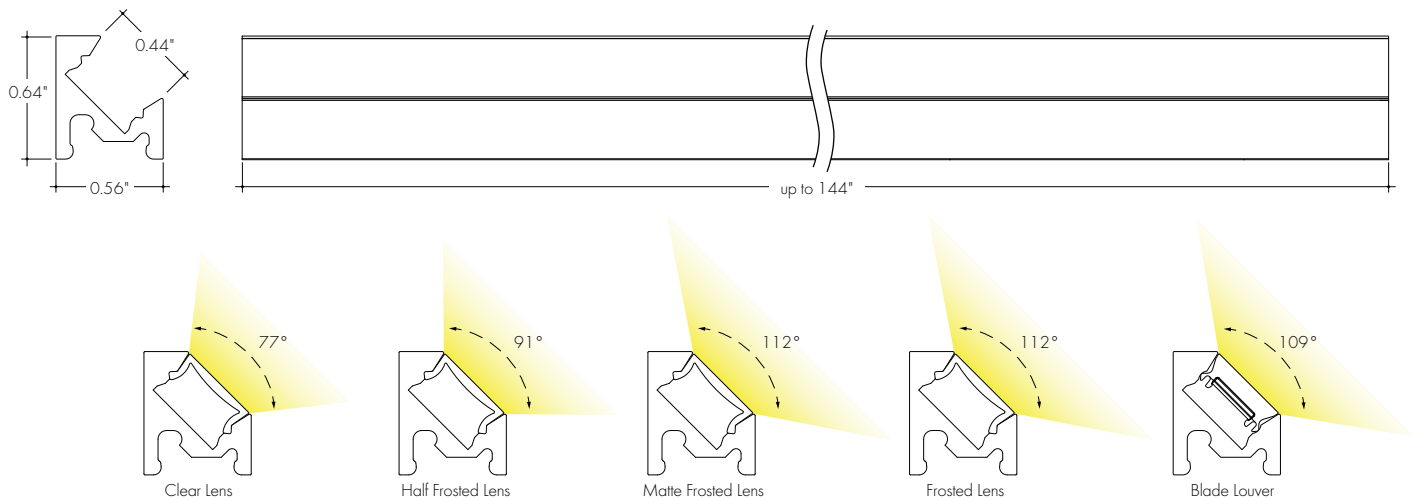

**INCLUDED MOUNTING ACCESSORIES**

EXTRUSION LENGTH	END CAP PAIR	CONCEALED BRACKET
48"	1	3
72"	1	4
96"	1	5
120"	1	6
144"	1	7

**TRANSMISSION PERCENTAGE**  
(COMPARED TO LED TAPE WITHOUT CHANNEL)

LENS	TRANSMISSION %
Clear	74%
Half Frosted	62%
Matte Frosted	58%
Frosted	46%
White Blade Louver	37%
Black Blade Louver	25%

See LED tape spec sheet for lens dotting characteristics & compatibility

Each pair of endcaps includes 1x H3 (no wire feed hole) and 1x H4 (with hole) where applicable. Additional endcaps and mounting clips are available for purchase.

**Ordering Code**

MODEL	LENGTH	LENS	MOUNTING <sup>2</sup>	FINISH <sup>4</sup>
MK45VC-Myka 45 Channel <sup>1</sup>	48-48" 72-72" 96-96" <sup>3</sup> 120-120" <sup>3</sup> 144-144" <sup>3</sup>	C-Clear F-Frosted HF-Half Frosted MF-Matte Frosted BLV-Black Blade Louver WLW-White Blade Louver	CB-Concealed Bracket	BASE SA-Silver Anodized  POWDER COATED BK-Black BZ-Bronze WH-White

1 - End Caps are included with channel, one of H3 (no hole) and one of H4 (with hole). Order additional End Caps as necessary.  
2 - Mounting Clips are included with channel. Refer to chart above for provided mounting clip quantities. Order additional Mounting Clips as necessary.

3 - For Channels and Lenses over 96", incremental shipping charges will apply.  
4 - Non SA finishes may have extended lead times and price adder. Custom RALs are available, please consult Inside Sales with specific request.

All Channels come with a specified set of Mounting Clips and End Caps, see Ordering Code for details. Order additional Mounting Clips and End Caps as necessary.

### Mounting Clips

**MB-MKC-CB**  
Myka Concealed Bracket  
**-CB**

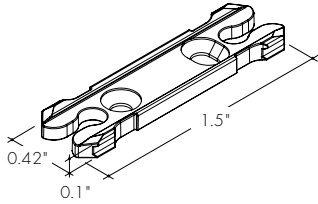

### Endcaps

**EC-MK45VC-F-L-H3-XX**  
Endcap with powerfeed opening

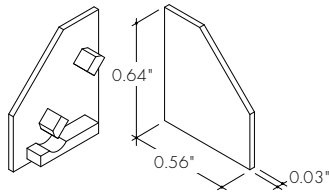

**EC-MK45VC-F-L-H4-XX**  
Endcap with H4 powerfeed opening

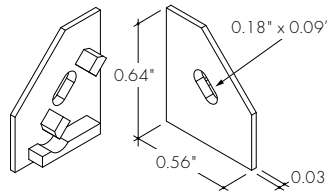

**EC-MK45VC-F-L-H5-XX**  
Endcap with H5 powerfeed opening

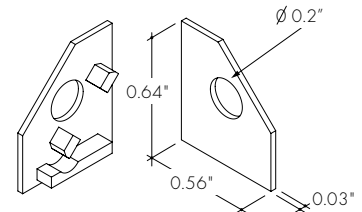

**EC-MK45VC-F-R-H3-XX**  
Endcap with powerfeed opening

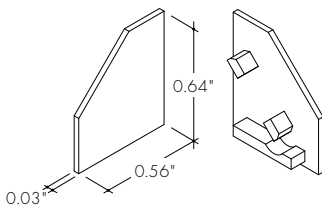

**EC-MK45VC-F-R-H4-XX**  
Endcap with H4 powerfeed opening

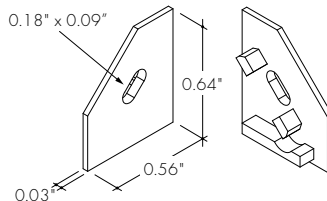

**EC-MK45VC-F-R-H5-XX**  
Endcap with powerfeed opening

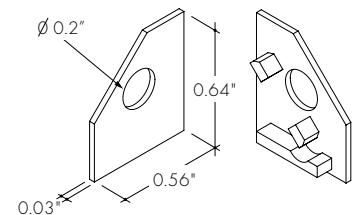

XX	Color
SA	Silver Anodized
WH	White
BK	Black
BZ	Bronze

### Regressed Blade Louver

**LV-BL-MKC-12-BK**  
Blade Louver reduces glare at high angle in two directions  
Also available with complete fixture, use ordering code  
**-BLV**

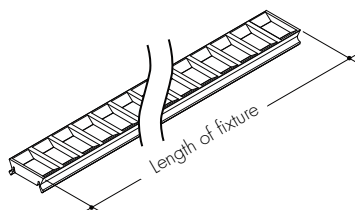

**LV-BL-MKC-12-WH**  
Blade Louver reduces glare at high angle in two directions  
Also available with complete fixture, use ordering code  
**-WLV**

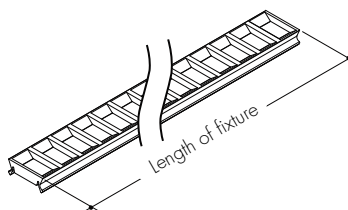

This Black louver/lens combo comes in 12" increments and sits in place of a Myka lens, not in addition to.

This White louver/lens combo comes in 12" increments and sits in place of a Myka lens, not in addition to.