

LETO 44 PLUS

WALL MOUNT ASYMMETRIC CYLINDER



Features

- Four output options available up to 2000 lumens.
- Nine drivers selections available to cover wide range of applications.
- Five year warranty.

Finish Options

- White
- Black
- Silver
- Mocha
- Charcoal
- Cerulean
- Firebrick

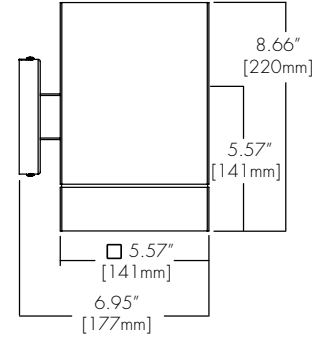

Technical Information

OUTPUT OPTIONS	700 lm	1000 lm	1500 lm	2000 lm
Fixture wattage	6.2 W	9.6 W	14.6 W	20.5 W
Delivered Lumen at 3500K	486 lm	730 lm	1134 lm	1620 lm
Efficacy	78 lm/W	76 lm/W	78 lm/W	79 lm/W
Center Beam Candlepower	757 cd	1137 cd	1767 cd	2524 cd

CCT	Multiplier	CRI	TM-30		
			R _f	R _g	R ₉
2500K	0.80	93+	93	102	50+
2700K	0.92	93+	92	100	50+
3000K	0.97	93+	92	103	50+
3500K	1.00	93+	93	102	50+
4000K	1.07	93+	92	101	50+
6500K	1.05	93+	92	101	50+

Ordering Code

Integral Driver Example: Fixture LET44P-WM-S-07-25K-ASM-DL-WH-WH-PHSD-NA

Remote Driver Example: Fixture LET44P-WM-S-07-25K-ASM-DL-WH-WH-PHSD-NA-HRM-LET44P-WM-07-25K-PHSD-NA

Fixture

MODEL	TYPE	SIZE	OUTPUT	CCT	OPTIC	ACCESSORY	BODY FINISH	BAFFLE FINISH
LET44P - Leto 44 Plus	WM - Wall Mount	S - Small ¹ M - Medium	07 - 700 (6.2W) 10 - 1000 (9.6W) 15 - 1500 (14.6W) 20 - 2000 (20.5W)	25K - 2500K 27K - 2700K 30K - 3000K 35K - 3500K 40K - 4000K 65K - 6500K	ASM - Asymmetric	DL - Diffusing Lens	Standard WH - White BK - Black SL - Silver Premium ² MA - Mocha CC - Charcoal CR - Cerulean FB - Firebrick	Standard WH - White BK - Black SL - Silver Premium ² MA - Mocha CC - Charcoal CR - Cerulean FB - Firebrick

DRIVER

DRIVER OPTIONS⁶

- PHSD - Forward/Reverse Phase, 1% Dimming, 120V Only
- 010S - 0-10V, 1% Dimming, 120/277V
- 0103 - 0-10V, 1% Dimming, 347V Only⁴
- 010L - EdoLED, 0-10V, Linear, 0.1% Dimming, 120/277V⁴
- 010G - EdoLED, 0-10V, Log, 0.1% Dimming, 120/277V⁴
- DALI - EdoLED, DALI Protocol 2, DT-6, 0.1% Dimming, 120/277V⁴
- DALI8 - EdoLED, DALI Protocol 2, DT-8, 0.1% Dimming, 120/277V⁴
- LUTE - Lutron HiLume Ecodigital, 1% Dimming, 120V/277V^{3,4}
- DMX - EdoLED, DMX, 0.1% Dimming, 120V/277V⁴

- NA - None
- EMG - Emergency Driver^{4,5}

- 1 - Size Small max output is 1500 lumens.
- 2 - Premium finishes may have extended lead times. Custom RALs are available, please consult Inside Sales with specific request.
- 3 - LUTE driver is not available at 700 lumens.
- 4 - 0103/010L/010G/DALI/DALI8/DMX/LUTE/EMG driver options will always require a remote driver.

- 5 - Emergency option comes prewired from factory with driver in remote housing. 8W of continuous power provided for a minimum of 90 minutes. Must be installed within 30 feet of luminaire using 18 AWG wire. Not available with 0103, DMX, DALI8 or LUTE Driver.
- 6 - AWRN/CSMB available upon request, contact Senso for details.

CONTACT FACTORY FOR MORE OPTIONS.

Lens

DL
Diffusing Lens



Remote Driver Housing

Depending on the options selected in the order code on page 1, a Remote Driver Housing may be required. This will automatically be generated and put on your order as necessary.

REMOTE DRIVER	MODEL	OUTPUT	CCT	DRIVER	DRIVER OPTIONS
HRM-Housing, Remote	LET44P-WM-Leto 44 Plus Wall Mount	Same as Fixture	Same as Fixture	Same as Fixture	Same as Fixture

Maximum mounting distance to luminaire using 18 AWG wire								
PHSD	010S	0103	010L	010G	DALI	DALI8	LUTE	DMX
16'	16'	16'	72'	72'	72'	72'	15'	149'

4" J-box

Minimum volume required to mount drivers in junction box: 70mm x 40mm x 30mm.

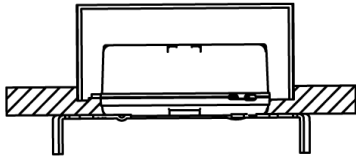

Driver
PHSD
010S

HRM Single with Externally Mounted Driver

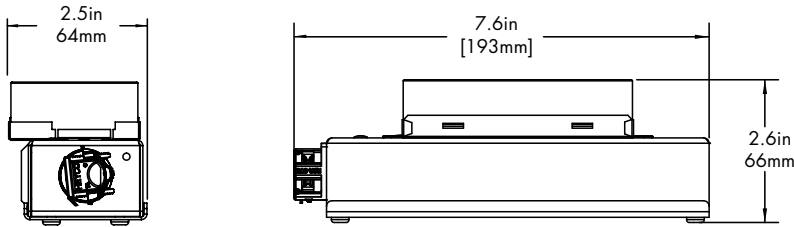

Driver
0103
010L
010G
DALI
LUTE

HRM Double

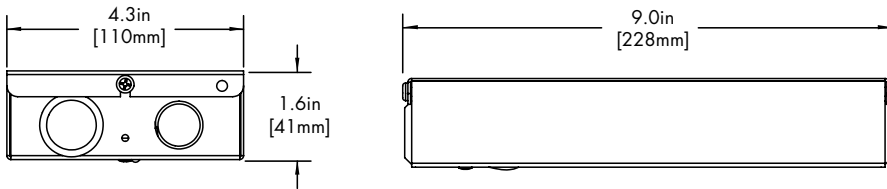

Driver
DALI8
DMX

EMG Emergency Driver

120 minute EMG operation time.

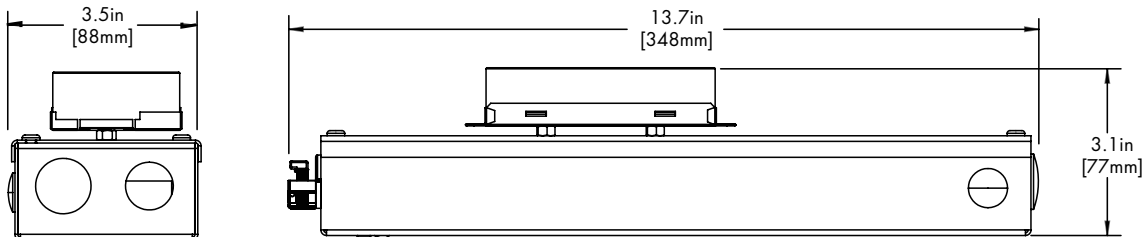

Driver
EMG

LETO 44 PLUS

WALL MOUNT ASYMMETRIC CYLINDER

Standard Finish

BK
Black



WH
White



SL
Silver



Premium Finish

Two tone with Black Baffle Finish. Any combination may be used for baffle and body finishes.

MA
Mocha



CC
Charcoal



CR
Cerulean

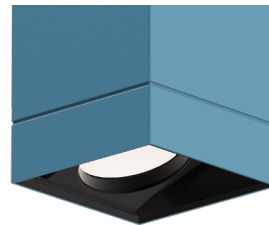

FB
Firebrick

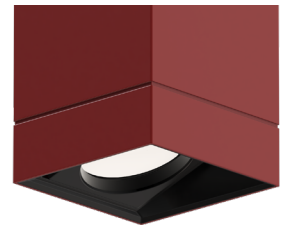

TM-30

2500K

COLOR VECTOR GRAPHIC

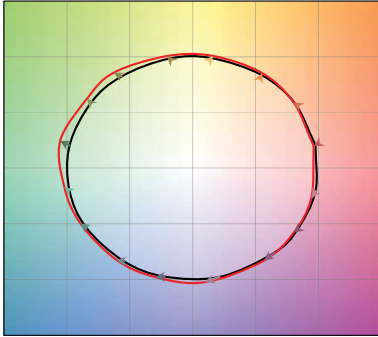

— Reference Source — Test Source

2700K

COLOR VECTOR GRAPHIC

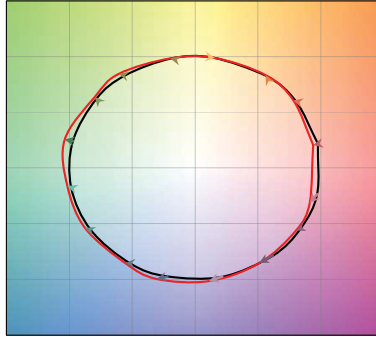

— Reference Source — Test Source

3000K

COLOR VECTOR GRAPHIC

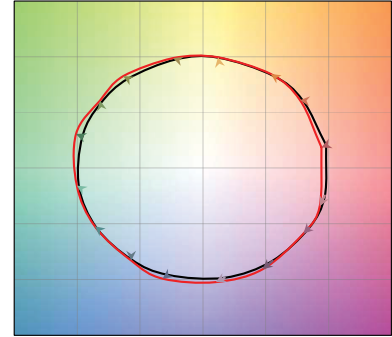

— Reference Source — Test Source

3500K

COLOR VECTOR GRAPHIC

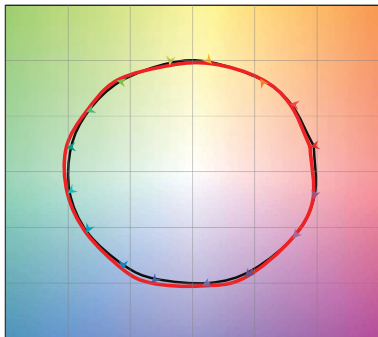

— Reference Source — Test Source

4000K

COLOR VECTOR GRAPHIC

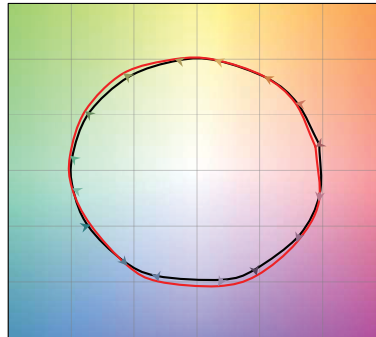

— Reference Source — Test Source

6500K

COLOR VECTOR GRAPHIC

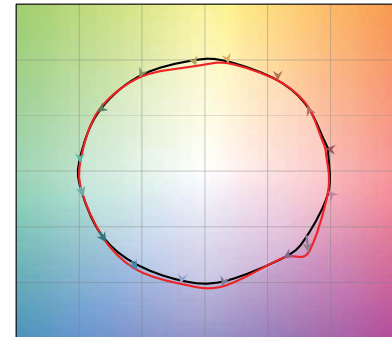

— Reference Source — Test Source

Photometry

ASM - Asymmetric

