

LETO 11 MINI

MONO POINT CYLINDER

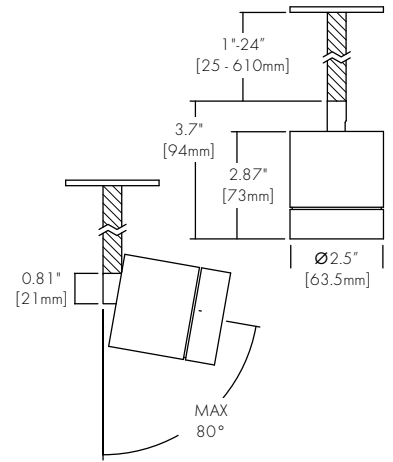

Features

- Faceted metal reflectors provide beam spreads between 20° to 60°.
- Output available up to 1000 lumens.
- Nine drivers selections available to cover wide range of applications.
- Five year warranty.



Finish Options

- White Silver Mocha Firebrick Warm Nickel
- Black Charcoal Cerulean Bronze Aged Brass

Technical Information

OUTPUT OPTIONS	700 lm	1000 lm
Size	S	S
Fixture wattage	4.8 W	7.4 W
Delivered Lumen	693 lm	1030 lm
Efficacy	145 lm/W	139 lm/W
Center Beam Candlepower (20° Faceted Reflector)	2349 cd	3492 cd

CCT	Multiplier	CRI	TM-30		
			R _f	R _g	R _o
2500K	0.80	93+	93	102	50+
2700K	0.92	93+	92	100	50+
3000K	0.97	93+	92	103	50+
3500K	1.00	93+	93	102	50+
4000K	1.07	93+	92	101	50+
6500K	1.05	93+	92	101	50+

Ordering Code

Integral Driver Example: Fixture LET11M-MP-S-07-25K-F20-NA-WH-WH-RDS-WH-SS01-WH-PHSD-NA

Remote Driver Example: Fixture LET11M-MP-S-07-25K-F20-NA-WH-WH-RDS-WH-SS01-WH-PHSD-NA-HRM-LET11M-MP-07-25K-PHSD-NA

Fixture

MODEL	TYPE	SIZE	OUTPUT	CCT	OPTIC	ACCESSORY	BODY FINISH	BAFFLE FINISH
LET11M-Leto 11 Mini	MP-Mono Point	S-Small	07-700 lumens (6.1W) ³ 10-1000 lumens (9.1W)	25K-2500K 27K-2700K 30K-3000K 35K-3500K 40K-4000K 65K-6500K	F20-20 Degree, Faceted F30-30 Degree, Faceted F60-60 Degree, Faceted	NA-No Accessory DL-Diffusing Lens	Standard WH-White BK-Black S-Silver Premium ¹ MA-Mocha CC-Charcoal CR-Cerulean FB-Firebrick BZ-Bronze WN-Warm Nickel AB-Aged Brass	Standard WH-White BK-Black S-Silver Premium ¹ MA-Mocha CC-Charcoal CR-Cerulean FB-Firebrick BZ-Bronze WN-Warm Nickel AB-Aged Brass
CANOPY/ HOUSING	CANOPY FINISH	SUSPENSION TYPE	SUSPENSION FINISH	DRIVER		DRIVER OPTIONS ⁵		
RDS-Round Slim SQS-Square Slim RTL-Round Flangeless RDR-Round Semi-Recessed	Standard WH-White BK-Black S-Silver Premium ¹ MA-Mocha CC-Charcoal CR-Cerulean FB-Firebrick BZ-Bronze WN-Warm Nickel AB-Aged Brass	SS01-Solid Stem, 1" SS06-Solid Stem, 6" SS1-Solid Stem, 12" SS2-Solid Stem, 24"	Standard WH-White BK-Black S-Silver Premium ¹ MA-Mocha CC-Charcoal CR-Cerulean FB-Firebrick BZ-Bronze WN-Warm Nickel AB-Aged Brass	PHSD-Forward/Reverse Phase, 1% Dimming, 120V Only 010S-0-10V, 1% Dimming, 120/277V 0103-0-10V, 1% Dimming, 347V Only ³ 010L-EldoLED, 0-10V, Linear, 0.1% Dimming, 120/277V ³ 010G-EldoLED, 0-10V, Log, 0.1% Dimming, 120/277V ³ DALI-EldoLED, DALI Protocol 2, DT-6, 0.1% Dimming, 120/277V ³ DALI8-EldoLED, DALI Protocol 2, DT-8, 0.1% Dimming, 120/277V ³ LUTE-Lutron Hilume Ecodigital, 1% Dimming, 120V/277V ^{2,3} DMX-EldoLED, DMX, 0.1% Dimming, 120V/277V ³		NA-None EMG-Emergency Driver ^{3,4}		

1 - Premium finishes may have extended lead times. Custom RALs are available, please consult Inside Sales with specific request.

2 - LUTE driver is not available at 700 lumens.

3 - Drivers 0103/010L/010G/DALI/DALI8/DMX/LUTE/EMG are only available with HRM - Remote Power Supply.

4 - Emergency option comes prewired from factory with driver in remote housing. 8W of continuous power provided for a minimum of 90 minutes. Must be installed within 30 feet of luminaire using 18 AWG wire. Not available with 0103, DMX, DALI8 or LUTE Driver.

5 - AAWN/CSMB available upon request.

CONTACT FACTORY FOR MORE OPTIONS.

Canopy

RDS
Round Slim Canopy

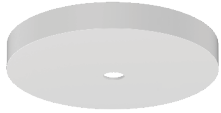
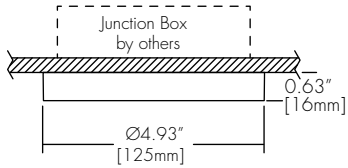

SQS
Square Slim Canopy

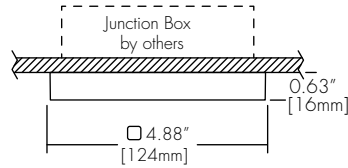

RTL
Round Flangless Canopy

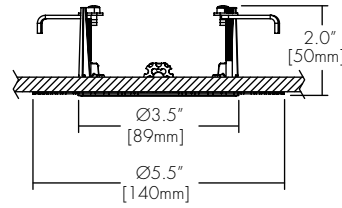

RDR
Semi-Recessed

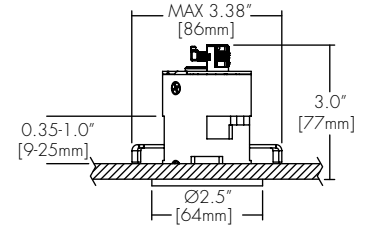

RDS or SQS	
Integral Drivers	PHSD, 010S
Remote Drivers	0103, 010L, 010G, DALI, DALI8, LUTE, DMX

RTL or RDR	
Integral Drivers	
Remote Drivers	PHSD, 010S, 0103, 010L, 010G, DALI, DALI8, LUTE, DMX

Suspension

SSX (1", 6", 12", 24")
Solid Stem



Lens & Accessory Options

DL
Diffusing Lens



Optics

FXX (20°, 30°, 60°)
Faceted Reflector



Remote Driver Housing

Depending on the options selected in the order code on page 1, a Remote Driver Housing may be required. This will automatically be generated and put on your order as necessary.

REMOTE DRIVER	MODEL	OUTPUT	CCT	DRIVER	DRIVER OPTIONS
HRM-Housing, Remote	LET11M-MP-Leto 11 Mini Mono Point	Same as Fixture	Same as Fixture	Same as Fixture	Same as Fixture

Maximum mounting distance to luminaire using 18 AWG wire							
010S	0103	PHSD	010L	010G	DALI	DMX	LUTE
16'	16'	16'	72'	72'	72'	149'	15'

4" J-box

Minimum volume required to mount drivers in junction box: 70mm x 40mm x 30mm.

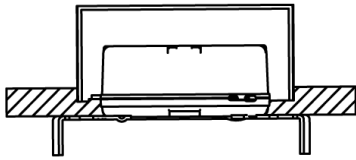

Canopy	+	Driver
RDS	+	PHSD
RDS	+	010S
SQS	+	PHSD
SQS	+	010S

HRM Single with Externally Mounted Driver

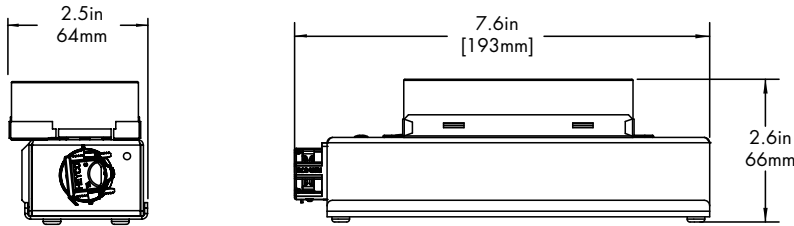

Driver
0103
010L
010G
010S
DALI
LUTE

HRM Double

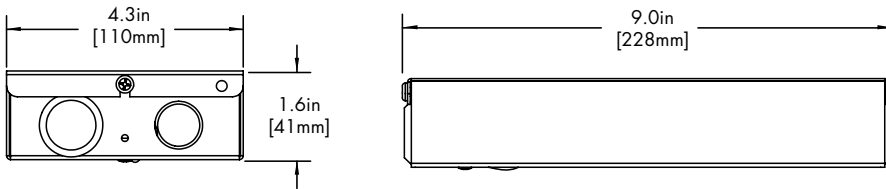

Driver
DALI8
DMX

HRM Cylinder Driver

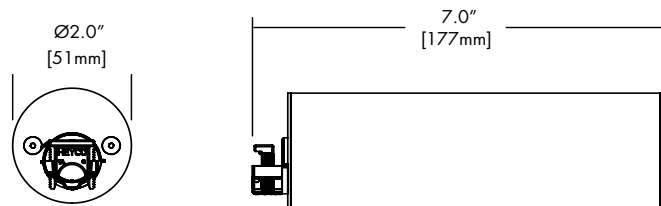

Canopy	+	Driver
RDR	+	010S
RDR	+	PHSD

EMG Emergency Driver

120 minute EMG operation time.

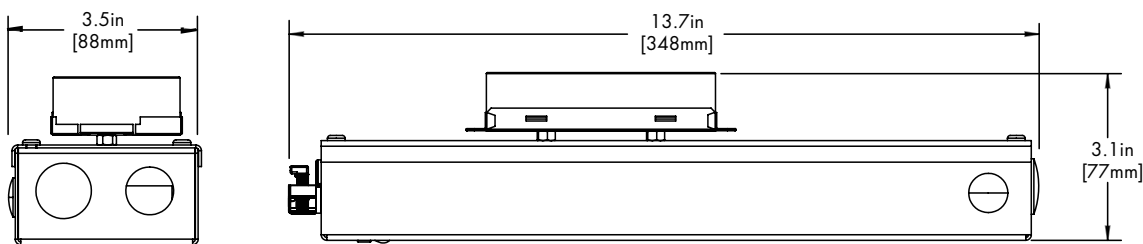

Driver
EMG

Standard Finishes

BK
Black



WH
White



SL
Silver



Premium Finishes

MA
Mocha



CC
Charcoal



CR
Cerulean



FB
Firebrick



BZ
Bronze



WN
Warm Nickle



AB
Antique Bronze



TM-30

2500K

COLOR VECTOR GRAPHIC

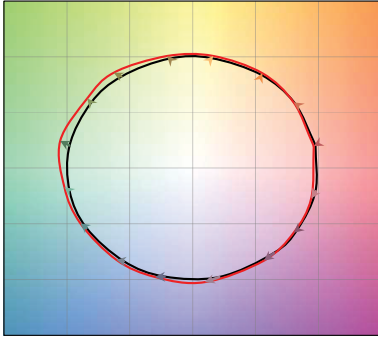

— Reference Source — Test Source

2700K

COLOR VECTOR GRAPHIC

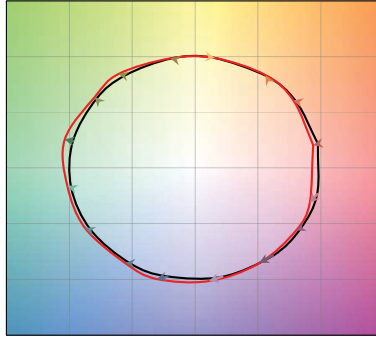

— Reference Source — Test Source

3000K

COLOR VECTOR GRAPHIC

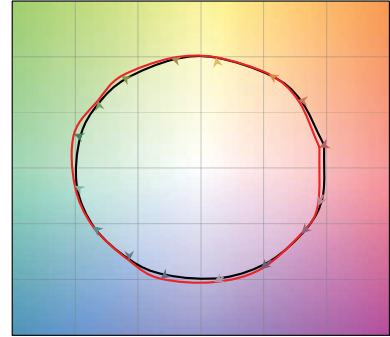

— Reference Source — Test Source

3500K

COLOR VECTOR GRAPHIC



— Reference Source — Test Source

4000K

COLOR VECTOR GRAPHIC



— Reference Source — Test Source

6500K

COLOR VECTOR GRAPHIC

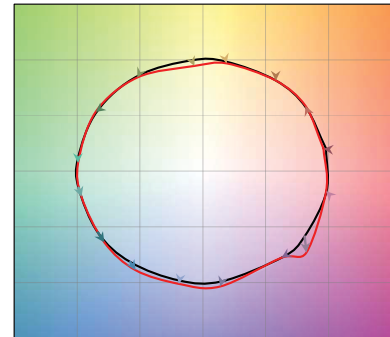

— Reference Source — Test Source

Photometry

20° Faceted Reflector

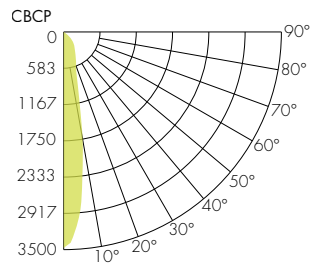
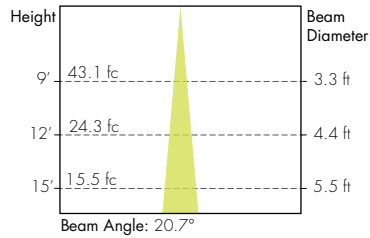

60° Faceted Reflector

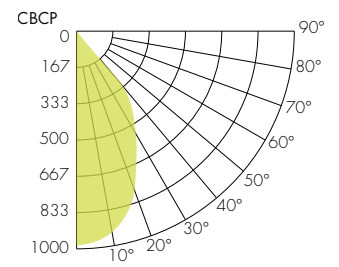
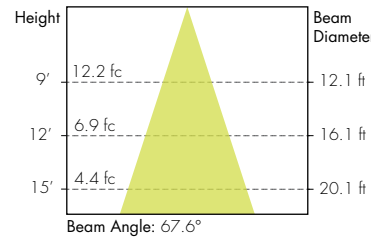

30° Faceted Reflector

