

Features

- Faceted reflector provides beam spreads between 18° to 60°.
- Nine driver selections available to cover wide range of applications.
- Four output options available up to 2000 lumens.
- 5 year warranty.



Finish Options

- White
- Black
- Silver
- Mocha
- Charcoal
- Cerulean
- Firebrick

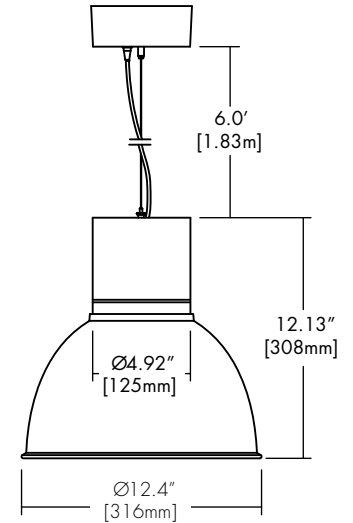

Technical Information

OUTPUT OPTIONS	700 lm	1000lm	1500lm	2000lm
Fixture wattage	7.5 W	10.4 W	14.5 W	20.1 W
Delivered Lumen	766 lm	1095 lm	1473 lm	2108 lm
Efficacy	102 lm/W	105 lm/W	102 lm/W	105 lm/W
Center Beam Candlepower (18° Faceted Reflector)	4482 cd	6406 cd	8618 cd	10970 cd

CCT	Multiplier	CRI	TM-30		
			R _f	R _g	R ₉
2500K	0.80	93+	93	102	50+
2700K	0.92	93+	92	100	50+
3000K	0.97	93+	92	103	50+
3500K	1.00	93+	93	102	50+
4000K	1.07	93+	92	101	50+
6500K	1.05	93+	92	101	50+

Ordering Code

Integral Driver Example: Fixture LET11-LBLP-07-25K-F18-CR-WH-WH-RD-WH-FC-NA-PHSD-NA
 Remote Driver Example: Fixture LET11-LBLP-07-25K-F18-CR-WH-WH-RD-WH-FC-NA-PHSD-NA-HRM-LET11-LBLP-07-25K-PHSD-NA

Fixture

MODEL	TYPE	OUTPUT	CCT	OPTIC	ACCESSORY	BODY FINISH	BAFFLE FINISH
LET11-Leto 11	LBLP-Low Bay Low Power	07-700 lumens (7.5W) 10-1000 lumens (10.4W) 15-1500 lumens (14.5W) 20-2000 lumens (19.5W)	25K-2500K 27K-2700K 30K-3000K 35K-3500K 40K-4000K 65K-6500K	F18-18 Degree, Faceted F30-30 Degree, Faceted F45-45 Degree, Faceted F60-60 Degree, Faceted	CR-Clear Reflector FR-Frosted Reflector MR-Metal Reflector	Standard WH-White BK-Black SL-Silver Premium ¹ MA-Mocha CC-Charcoal CR-Cerulean FB-Firebrick	Standard WH-White BK-Black SL-Silver Premium ¹ MA-Mocha CC-Charcoal CR-Cerulean FB-Firebrick

CANOPY/ HOUSING	CANOPY FINISH	SUSPENSION TYPE	SUSPENSION FINISH	DRIVER	DRIVER OPTIONS
RD-Round RTL-Round Flangeless ⁴ SQ-Square	Standard WH-White BK-Black SL-Silver Premium ¹ MA-Mocha CC-Charcoal CR-Cerulean FB-Firebrick	FC-Feed Cable 1AF-1AC+Feed Cable 2AF-2AC+Feed Cable SS2-Solid Stem, 2' SS3-Solid Stem, 3' SS6-Solid Stem, 6' HS2-Hang Straight, 2' HS3-Hang Straight, 3' HS6-Hang Straight, 6' POA-POA	Standard NA-None CL-Clear WH-White BK-Black SL-Silver Premium ¹ MA-Mocha CC-Charcoal CR-Cerulean FB-Firebrick	PHSD-Forward/Reverse Phase, 1% Dimming, 120V Only 010S-0-10V, 1% Dimming, 120/277V 0103-0-10V, 1% Dimming, 347V Only 010L-EldoLED, 0-10V, Linear, 0.1% Dimming, 120/277V ³ 010G-EldoLED, 0-10V, Log, 0.1% Dimming, 120/277V ³ DALI-EldoLED, DALI Protocol 2, DT-6, 0.1% Dimming, 120/277V ³ DALI8-EldoLED, DALI Protocol 2, DT-8, 0.1% Dimming, 120/277V ⁴ LUTE-Lutron Hilume Ecodigital, 1% Dimming, 120V/277V ^{2,3} DMX-EldoLED, DMX, 0.1% Dimming, 120V/277V ⁴	NA-None EMG-Emergency Driver ^{4,5} CSMB-Casambi ^{6,7} AWN- Athena ^{6,7}

1 - Premium finishes may have extended lead times. Custom RALs are available, please consult Inside Sales with specific request.
 2 - LUTE driver is not available at 700 lumens.
 3 - Requires SQ square canopy for integral driver, otherwise remote mounted.
 4 - All drivers remote mounted when using RTL canopy, DALI8 driver, DMX driver, or EMG driver options.

5 - Emergency option comes prewired from factory with driver in remote housing. 8W of continuous power provided for a minimum of 90 minutes. Must be installed within 30 feet of luminaire using 18 AWG wire. Not available with 0103, DMX, DALI8 or LUTE Driver.
 6 - AwnR/CSMB only available with 010S driver and RD/SQ canopy.
 7 - AwnR/CSMB available upon request with RTL canopy.

CONTACT FACTORY FOR MORE OPTIONS.

Canopy

RD Round Canopy



Integral Drivers	Remote Drivers
010S	010L
0103	010G
PHSD	DAI
	DAI8
	LUTE
	DMX

RTL Round Flangless Canopy

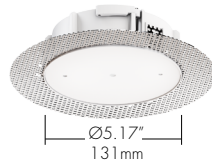

Integral Drivers	Remote Drivers
N/A	010S
	0103
	PHSD
	010L
	010G
	DAI
	DAI8
	LUTE
	DMX

SQ Square Canopy

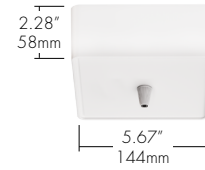

Integral Drivers	Remote Drivers
010S	DAI8
0103	DMX
PHSD	
010L	
010G	
DAI	
LUTE	

Please see next page for Remote Driver Housing details.

Suspension

FC Feed Cable



1AF 1 Aircraft + Feed Cable



2AF 2 Aircraft + Feed Cable



SSX (2', 3', 6' max) Solid Stem



HSX (2', 3', 6' max) Hang Straight Solid Stem



Maximum Slope: 30°

POA 2 Powered Aircraft



Accessories

CR Clear Reflector



FR Frosted Reflector



MR Metal Reflector



Remote Driver Housing

Depending on the options selected in the order code on page 1, a Remote Driver Housing may be required. This will automatically be generated and put on your order as necessary.

REMOTE DRIVER	MODEL	OUTPUT	CCT	DRIVER	DRIVER OPTIONS
HRM-Housing, Remote	LET11-LBLP-Leto 11 Low Bay Low Power	Same as Fixture	Same as Fixture	Same as Fixture	Same as Fixture

Maximum mounting distance to luminaire using 18 AWG wire								
PHSD	010S	0103	010L	010G	DALI	DALI8	LUTE	DMX
16'	16'	16'	72'	72'	72'	72'	15'	149'

HRM Single with Externally Mounted Driver

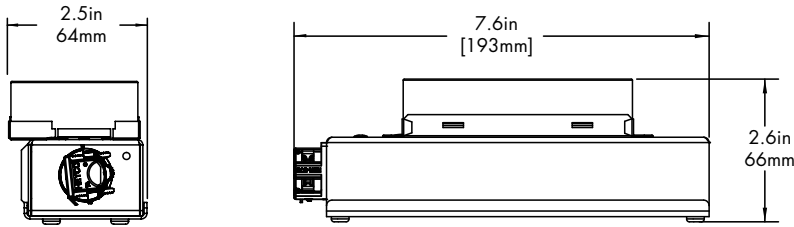

Canopy	+	Driver
RTL	+	0103
RD or RTL	+	010L
RD or RTL	+	010G
RD or RTL	+	DALI
RD or RTL	+	LUTE

HRM Single

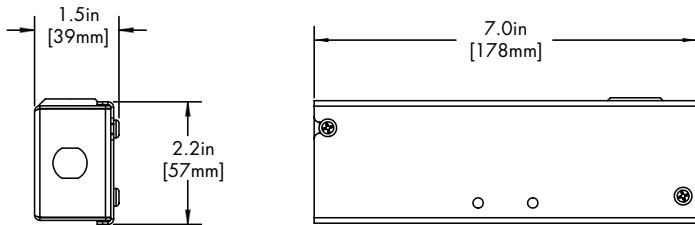

Canopy	+	Driver
RTL	+	PHSD
RTL	+	010S

HRM Double

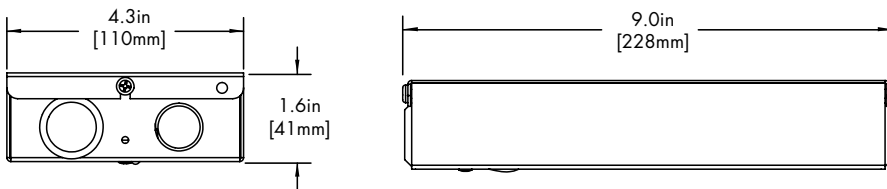

Driver
DALI8
DMX

EMG Emergency Driver

120 minute EMG operation time.

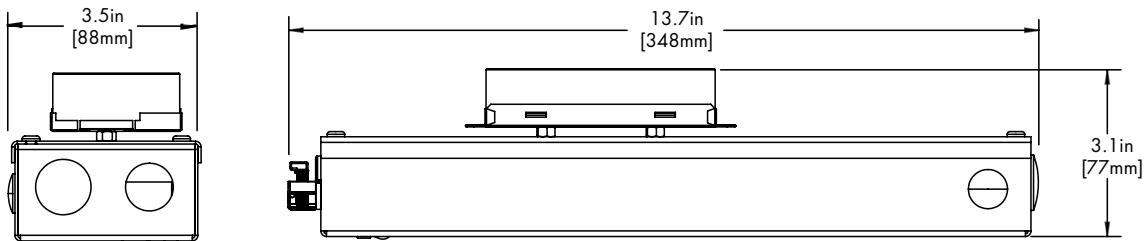

Driver
EMG

Standard Finishes

BK
Black



WH
White



SL
Silver



Premium Finishes

MA
Mocha



CC
Charcoal



CR
Cerulean



FB
Firebrick



Two Tone Baffle

Inside finish refers to Baffle Finish selection from page 1. Any combination may be used for baffle and body finishes.

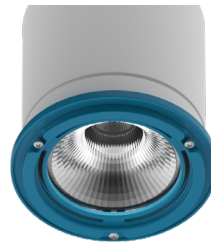

TM-30

2500K

COLOR VECTOR GRAPHIC

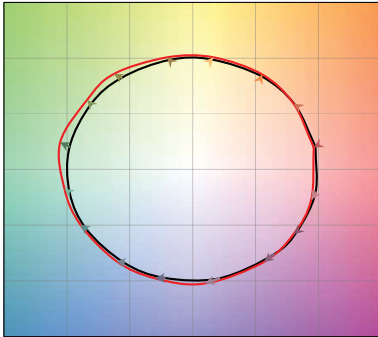

— Reference Source — Test Source

2700K

COLOR VECTOR GRAPHIC

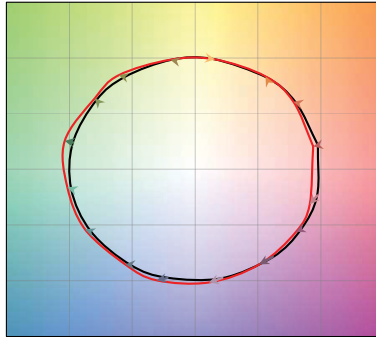

— Reference Source — Test Source

3000K

COLOR VECTOR GRAPHIC

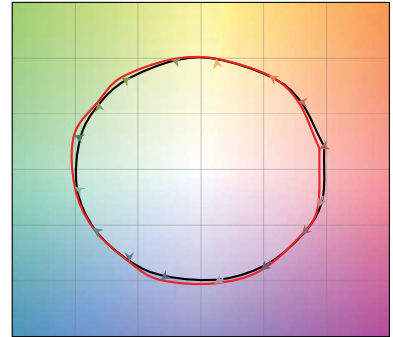

— Reference Source — Test Source

3500K

COLOR VECTOR GRAPHIC

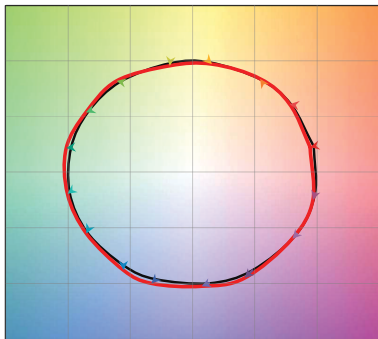

— Reference Source — Test Source

4000K

COLOR VECTOR GRAPHIC

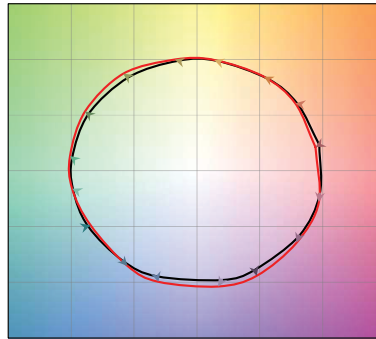

— Reference Source — Test Source

6500K

COLOR VECTOR GRAPHIC

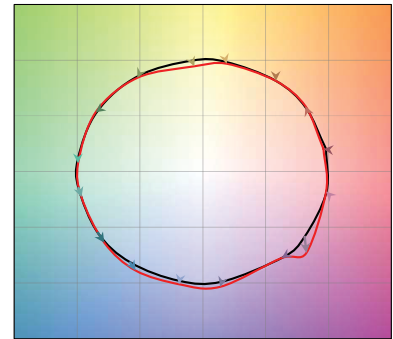

— Reference Source — Test Source

Photometry

18° Faceted Reflector

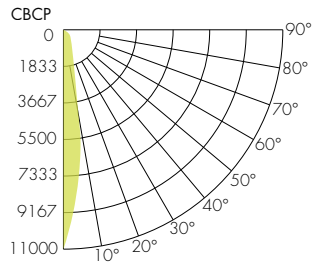
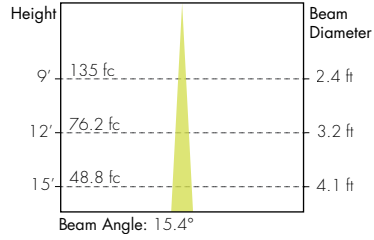

30° Faceted Reflector

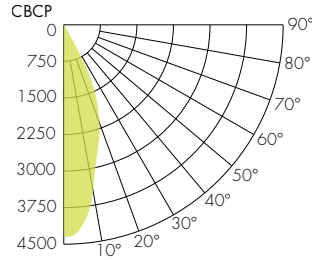
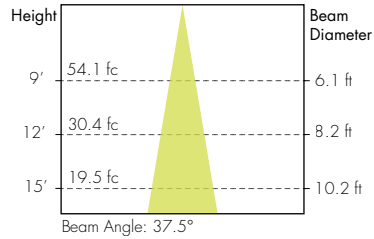

45° Faceted Reflector

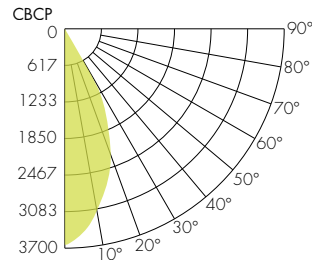
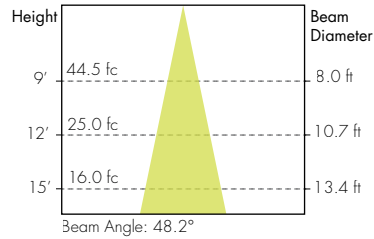

60° Faceted Reflector

