

LETO 11 ADJ

ADJUSTABLE SUSPENDED CYLINDER

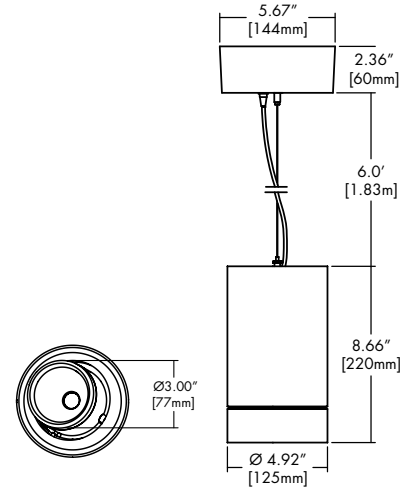

Features

- 360° rotation and up to 30° total tilt.
- Field interchangeable faceted metal reflectors and TIR optics provide adjustable beam spreads between 15° to 60°.
- Six output options available up to 3500 lumens.
- Nine driver selections available to cover wide range of applications.
- Five year warranty.

Finish Options

- White
- Mocha
- Black
- Charcoal
- Silver
- Cerulean
- Firebrick



Technical Information

OUTPUT OPTIONS	700 lm	1000 lm	1500lm	2000lm	3000lm	3500lm	TM-30					
							CCT	Multiplier	CRI	R _f	R _g	R ₉
Fixture wattage	6.1 W	9.1 W	14.0 W	19.8 W	31.8 W	35.9 W						
Delivered Lumen at 3500K	721 lm	1067 lm	1604 lm	2180 lm	3155 lm	3496 lm						
Efficacy	118 lm/W	117 lm/W	115 lm/W	110 lm/W	99 lm/W	97 lm/W						
Center Beam Candlepower (18° Faceted Reflector)	3123 cd	4621 cd	6947 cd	9442 cd	13665 cd	15142 cd						

Integral Driver Example: Fixture LET11A-S-07-25K-F18-NA-WH-WH-RD-WH-2AF-NA-PHSD-NA
 Remote Driver Example: Fixture LET11A-S-07-25K-F18-NA-WH-WH-RD-WH-2AF-NA-PHSD-NA
 HRM-LET11A-S-07-25K-PHSD-NA

Ordering Code

Fixture

MODEL	TYPE	OUTPUT	CCT	OPTIC	ACCESSORY*	BODY FINISH	BAFFLE FINISH
LET11A-Leto 11 Adjustable	S-Suspended	07-700 lumens (6.1W) ¹ 10-1000 lumens (9.1W) 15-1500 lumens (14.0W) 20-2000 lumens (19.8W) 30-3000 lumens (31.8W) 35-3500 lumens (34.6W)	25K-2500K 27K-2700K 30K-3000K 35K-3500K 40K-4000K 65K-6500K	F18-18 Degree, Faceted F30-30 Degree, Faceted F45-45 Degree, Faceted F60-60 Degree, Faceted T15-15 Degree, TIR ² T20-23 Degree, TIR ² T30-36 Degree, TIR ²	NA-No Accessory CL-Clear Lens DL-Diffusing Lens HC-Honeycomb Louver SL-Solite Lens	Standard WH-White BK-Black SL-Silver Premium ³ MA-Mocha CC-Charcoal CR-Cerulean FB-Firebrick	Standard WH-White BK-Black SL-Silver Premium ³ MA-Mocha CC-Charcoal CR-Cerulean FB-Firebrick

CANOPY/ HOUSING	CANOPY FINISH	SUSPENSION TYPE	SUSPENSION FINISH	DRIVER	DRIVER OPTIONS
RD-Round RTL-Round Trimless ⁴ SQ-Square	Standard WH-White BK-Black SL-Silver Premium ³ MA-Mocha CC-Charcoal CR-Cerulean FB-Firebrick	2AF-2AC+Feed Cable SS2-Solid Stem, 2ft SS3-Solid Stem, 3ft SS6-Solid Stem, 6ft ⁵ HS2-Hang Straight, 2ft ⁵ HS3-Hang Straight, 3ft ⁵ HS6-Hang Straight, 6ft ⁵ POA-2 Powered Aircraft	Standard NA-None ⁷ CL-Clear WH-White BK-Black SL-Silver ⁶ Premium ³ MA-Mocha ⁶ CC-Charcoal ⁶ CR-Cerulean ⁶ FB-Firebrick ⁶	PHSD-Forward/Reverse Phase, 1% Dimming, 120V Only 010S-0-10V, 1% Dimming, 120V/277V 0103-0-10V, 1% Dimming, 347V Only 010L-EldoLED, 0-10V, Linear, 0.1% Dimming, 120V/277V ⁸ 010G-EldoLED, 0-10V, Log, 0.1% Dimming, 120V/277V ⁸ DALI-EldoLED, DALI Protocol 2, DF-6, 0.1% Dimming, 120V/277V ⁸ DALI8-EldoLED, DALI Protocol 2, DF-8, 0.1% Dimming, 120V/277V ⁸ LUTE-Lutron HiLume Ecodigital, 1% Dimming, 120V/277V ^{1,5} DMX-EldoLED, DMX, 0.1% Dimming, 120V/277V ⁴	NA-None EMG-Emergency Driver ^{4,9} CSMB-Cosambi ¹⁰ AWNAR-Athena ¹⁰

1 - LUTE driver is not available at 700 lumens.
 2 - Optics T15/T20/T30 have a maximum of 2000 Lumens.
 3 - Premium finishes may have extended lead times. Custom RALs are available, please consult Inside Sales with specific request.
 4 - All drivers remote mounted when using RTL canopy, DALI8 driver, DMX driver, or EMG driver options.
 5 - HS2/HS3/HS6 Suspension are not available with RTL Canopy.
 6 - These finishes are only available with SS Solid Stem or HS Hang Straight.
 7 - Must select NA None when POA 2 Powered Aircraft Suspension Type is selected.
 8 - Requires SQ square canopy for integral driver, otherwise remote mounted.
 9 - Emergency option comes prewired from factory with driver in remote housing. 8W of continuous power provided for a minimum of 90 minutes. Must be installed within 30 feet of luminare using 18 AWG wire. Not available with 0103, DMX, DALI8 or LUTE Driver.
 10 - AWNR/CSMB only available with 010S driver and RD/SQ canopy.

CONTACT FACTORY FOR MORE OPTIONS.

LETO 11 ADJ

ADJUSTABLE SUSPENDED CYLINDER

Canopy

RD Round Canopy

 <p>2.36" 60mm</p> <p>Ø5.17" 131mm</p>	Integral Drivers	Remote Drivers
	010S 0103 PHSD	010L 010G DALI DALI8 LUTE DMX

RTL Round Trimless Canopy

 <p>Ø5.17" 131mm</p>	Integral Drivers	Remote Drivers
	N/A	010S 0103 PHSD 010L 010G DALI DALI8 LUTE DMX

SQ Square Canopy

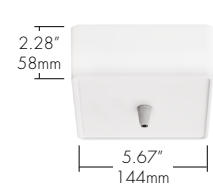
 <p>2.28" 58mm</p> <p>5.67" 144mm</p>	Integral Drivers	Remote Drivers
	010S 0103 PHSD 010L 010G DALI LUTE	DALI8 DMX

Please see next page for Remote Driver Housing details.

Suspension

2AF 2 Aircraft + Feed Cable



SSX (2', 3', 6' max) Solid Stem



HSX (2', 3', 6' max) Hang Straight Solid Stem



Maximum Slope: 15°

POA 2 Powered Aircraft



Lens & Accessory Options

OPTC-ACC-CL-65MM

Clear Lens
Also available with complete fixture, use ordering code.
-CL



OPTC-ACC-DL-65MM

Diffusing Lens
Also available with complete fixture, use ordering code.
-DL



OPTC-ACC-HC-65MM

Honeycomb Lens
Also available with complete fixture, use ordering code.
-HC



OPTC-ACC-SL-65MM

Solite Lens
Also available with complete fixture, use ordering code.
-SL



Optics

RFLC-FXX-60MM

Faceted Reflector
Also available with complete fixture, use ordering code.
-F18/-F30/-F45/-F60



RFLC-TXX-60MM

TIR
Also available with complete fixture, use ordering code.
-T15/-T20/-T30



FXX	Optic
F18	18° Faceted
F30	30° Faceted
F45	45° Faceted
F60	60° Faceted

TXX	Optic
T15	15° TIR
T20	23° TIR
T30	36° TIR

Remote Driver Housing

Depending on the options selected in the order code on page 1, a Remote Driver Housing may be required. This will automatically be generated and put on your order as necessary.

REMOTE DRIVER	MODEL	OUTPUT	CCT	DRIVER	DRIVER OPTIONS
HRM-Housing, Remote	LET11A-S-Leto 11 Adjustable Suspended	Same as Fixture	Same as Fixture	Same as Fixture	Same as Fixture

Maximum mounting distance to luminaire using 18 AWG wire								
PHSD	010S	0103	010L	010G	DALI	DALI8	LUTE	DMX
16'	16'	16'	72'	72'	72'	72'	15'	149'

HRM Single with Externally Mounted Driver

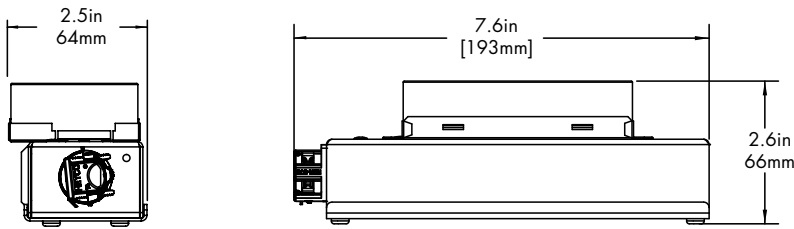

Canopy	+	Driver
RTL	+	0103
RD or RTL	+	010L
RD or RTL	+	010G
RD or RTL	+	DALI
RD or RTL	+	LUTE

HRM Single

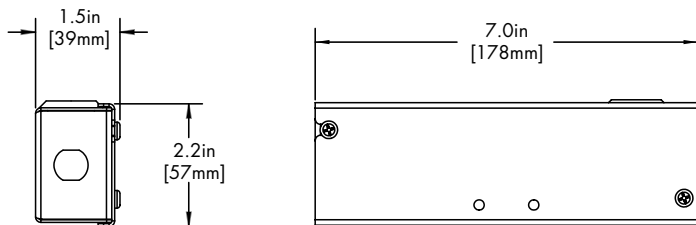

Canopy	+	Driver
RTL	+	PHSD
RTL	+	010S

HRM Double

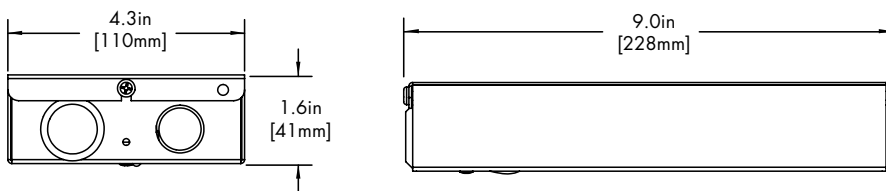

Driver
DALI8
DMX

EMG Emergency Driver

120 minute EMG operation time.

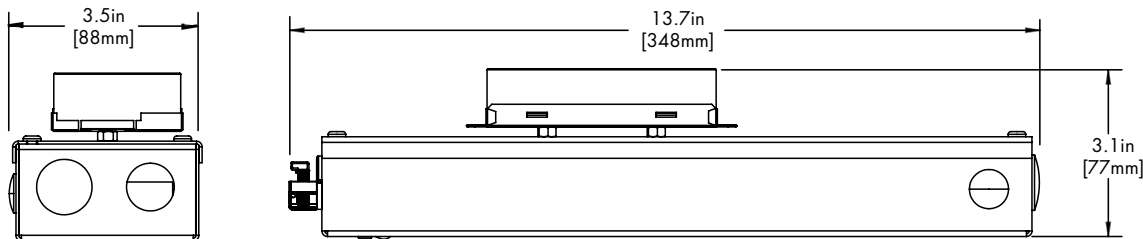

Driver
EMG

LETO 11 ADJ

ADJUSTABLE SUSPENDED CYLINDER

Standard Finish

BK
Black



WH
White



SL
Silver



Premium Finish

Two tone with Black Baffle Finish. Any combination may be used for baffle and body finishes.

MA
Mocha



CC
Charcoal



CR
Cerulean



FB
Firebrick



TM-30

2500K

COLOR VECTOR GRAPHIC

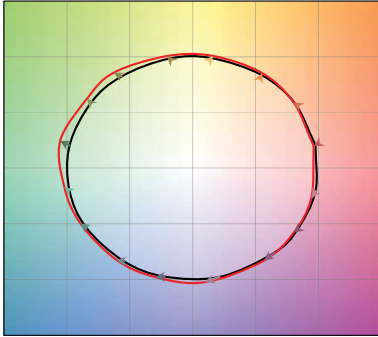

— Reference Source — Test Source

2700K

COLOR VECTOR GRAPHIC

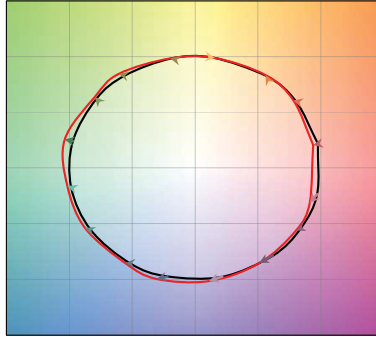

— Reference Source — Test Source

3000K

COLOR VECTOR GRAPHIC

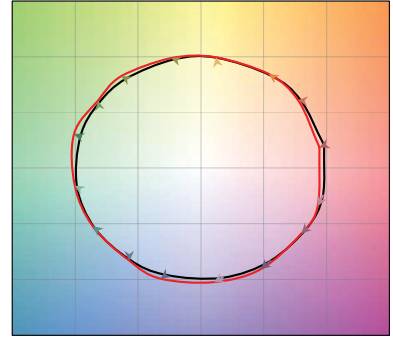

— Reference Source — Test Source

3500K

COLOR VECTOR GRAPHIC

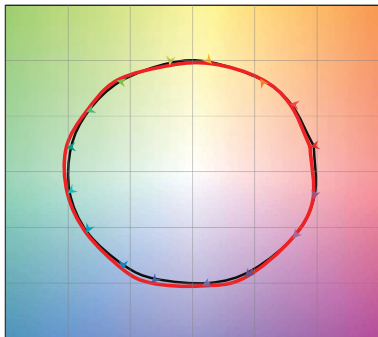

— Reference Source — Test Source

4000K

COLOR VECTOR GRAPHIC

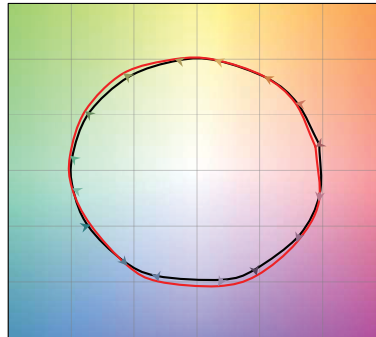

— Reference Source — Test Source

6500K

COLOR VECTOR GRAPHIC

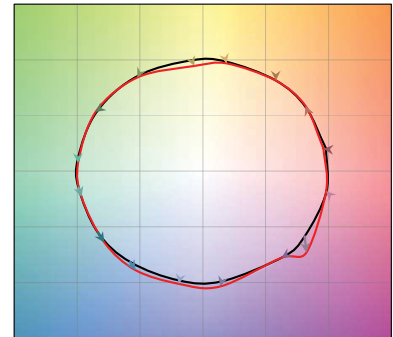

— Reference Source — Test Source

Photometry

18° Faceted Reflector

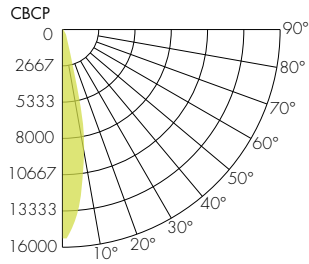
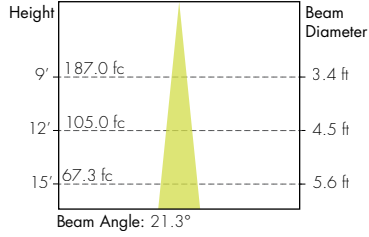

15° TIR

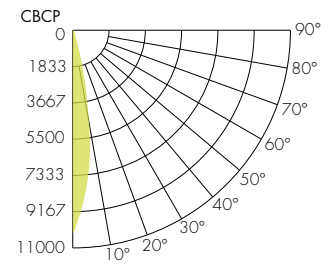
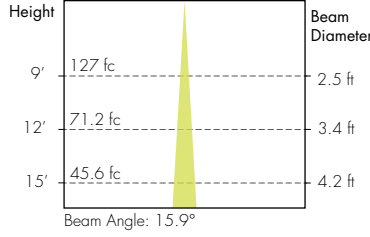

30° Faceted Reflector

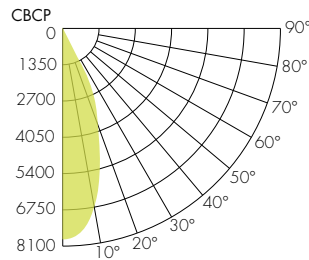
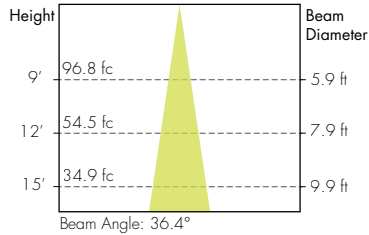

23° TIR

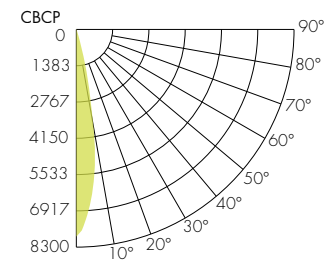
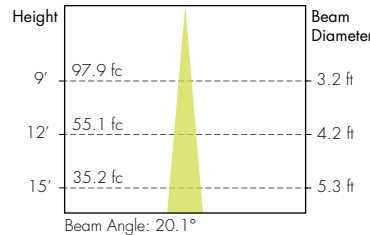

45° Faceted Reflector

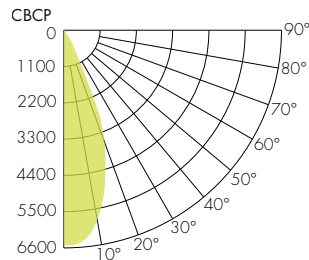
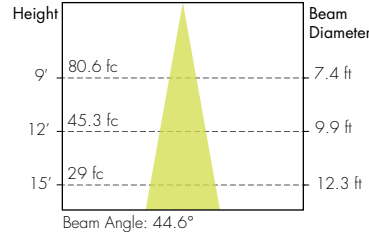

36° TIR

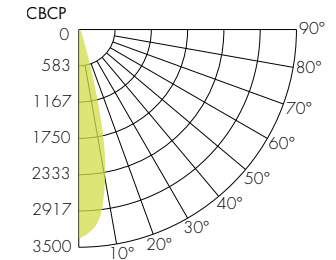
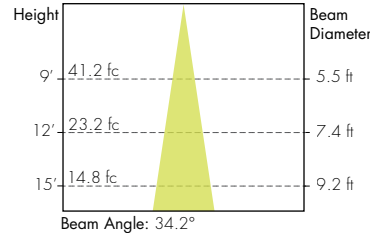

60° Faceted Reflector

