

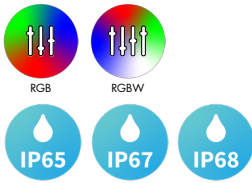

LLX18WET-RGBW

Applications: outdoor / wet location, above cabinet, cove lighting, counter accent, architectural accents, under banisters, decks, gazebos, barbeque stations and wet bars.



## Features

LineLED RGB & RGBW Wet Tube is a new small profile, more energy efficient LED strip for wet locations. The LineLED RGB & RGBW Wet Tube has superior light output, a durable but flexible circuit board and it is very easy to install.

Due to the sealing bond needed to guarantee the wet-rating, exact lengths are required to order the LineLED Wet Tube. Extending and turning corners in the field require custom production.

### Mounting

LED strip is equipped with 3M™ VHB™ adhesive transfer tape.

### Approvals

IP65 & IP68 rated

### Beam Angle

120°

Operating voltage  
24 VDC

Average life  
50,000 hours

Warranty  
3 years



Declare.

## Technical information

TYPE	RGB	RGBW (3000K)
<b>OUTPUT OPTIONS</b>	<b>SO</b>	<b>SO</b>
Lumens Output (all channels full on)	161 lm/ft	230 lm/ft
Average Power Consumption (for a 4' section)	3.9 W/ft	4.9 W/ft
Efficacy	34 lm/W	40 lm/W
Cutting Increment	4.00"	
Pitch Length	0.66"	
Max Run Length (in series)	30 ft	20 ft
Max Strip Length	16 ft	
Dimensions	0.47" W 0.24" H	0.52" W 0.24" H

Tape	RGBW (3000K)			
	CRI	R <sub>f</sub>	R <sub>g</sub>	R <sub>b</sub>
LLRGBWX18-SO	93	91	99	64

Dominant Wavelength	
Color	RGB/RGBW
Red	621nm
Green	519nm
Blue	465nm

### Section Start/End Options

#### SL65

72" Soldered Leads, IP65 rated

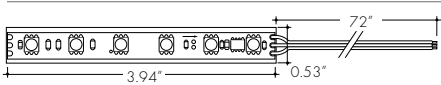

#### SL68

72" Soldered Leads, IP68 rated

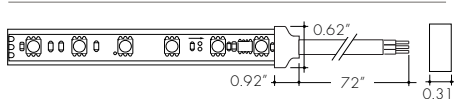

#### LF

Female Quick Connect End, IP67 rated

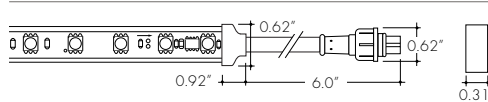

#### LM

Male Quick Connect End, IP67 rated

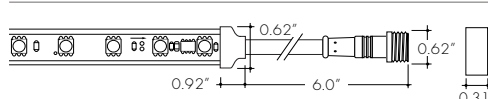

#### NC

No Connector

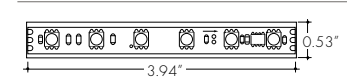

IP65 rated when used with SL65 selection

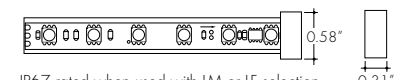

IP67 rated when used with LM or LF selection  
IP68 rated when used with SL68 selection

## Ordering code

MODEL	ENCLOSURE	COLOR	SECTION START	SECTION END	LENGTH
LLX18WET	T-Tube	RGB - Red, Green, & Blue RGBW - Red, Green, Blue, & White (3000K)	SL65 - IP65 Soldered lead wires (72") SL68 - IP68 Soldered lead wires (72") F - Female connector M - Male connector NC - No connector	SL65 - IP65 Soldered lead wires (72") SL68 - IP68 Soldered lead wires (72") F - Female connector M - Male connector NC - No connector	view table above for increment options and maximum run limits

### Power consumption per linear foot\*

\* with all 4 circuits at full brightness

RGB					
Length of Strip (LF)	W/ft	Total wattage	Length of Strip (LF)	W/ft	Total wattage
1	4.60	4.60	21	3.55	74.55
2	4.55	9.10	22	3.45	75.90
3	4.50	13.50	23	3.40	78.20
4	4.45	17.80	24	3.35	80.40
5	4.40	22.00	25	3.30	82.50
6	4.35	26.10	26	3.25	84.50
7	4.30	30.10	27	3.15	85.05
8	4.25	34.00	28	3.10	86.80
9	4.20	37.80	29	3.05	88.45
10	4.15	41.50	30	3.00	90.00
11	4.10	45.10			
12	4.05	48.60			
13	4.00	52.00			
14	3.95	55.30			
15	3.90	58.50			
16	3.85	61.60			
17	3.75	63.75			
18	3.70	66.60			
19	3.65	69.35			
20	3.60	72.00			

RGBW		
Length of Strip (LF)	W/ft	Total wattage
1	5.65	5.65
2	5.65	11.30
3	5.65	16.95
4	5.60	22.40
5	5.50	27.50
6	5.45	32.70
7	5.35	37.45
8	5.30	42.40
9	5.25	47.25
10	5.20	52.00
11	5.15	56.65
12	5.10	61.20
13	5.05	65.65
14	4.95	69.30
15	4.85	72.75
16	4.75	76.00
17	4.60	78.20
18	4.50	81.00
19	4.40	83.60
20	4.30	86.00

### Accessories

Mounting clip:  
recommended at every 12" when  
LineLED strip is facing down.

Part # CL2

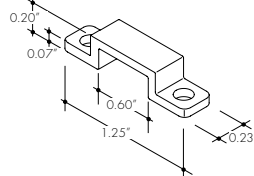

Splice Box:  
Wet rated, low voltage  
splice box, gray

Part # LVSP-WET

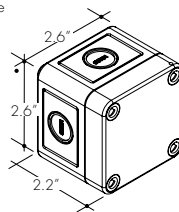

Connector:  
low voltage splice box wet cable  
management gray

Part # LVSP-WET-CM

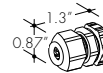

Male/Female Joiner:  
Linking and extension cable in 12" or 48"

Part # IP68-RGB-12  
IP68-RGB-48

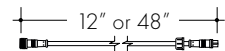

Part # LL.ZIP

Cable/Wire Strain Relief Clip

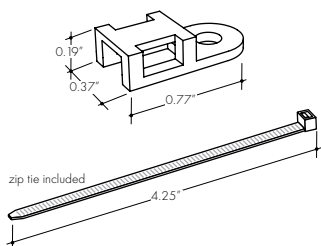

**C**  
Clear

**HF**  
Half (50%)  
Frosted

**GR**  
Graze

**F**  
Frosted

**FF**  
Flat  
Frosted

**R**  
Raised

**S**  
Square  
Frosted

**Q**  
Round Square  
Frosted

**13°**  
13°  
Semi-Frosted

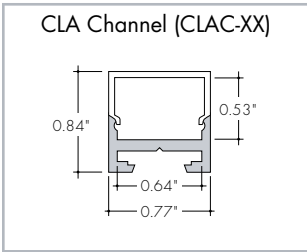

**S** 62% **Q** 65%

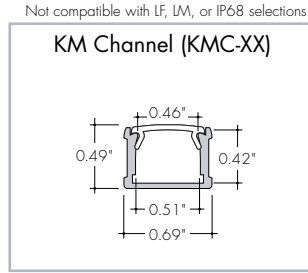

**C** 82% **HF** 68% **F** 45% **FF** 52% **R** 58%

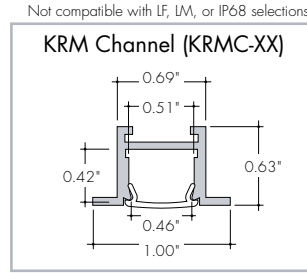

**C** 82% **HF** 68% **F** 45% **FF** 52%

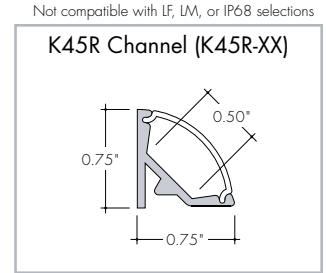

**RF** 61%

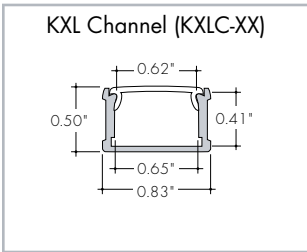

**C** 79% **HF** 66% **F** 49%

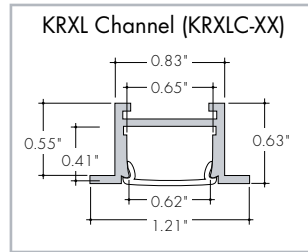

**C** 79% **HF** 66% **F** 49%

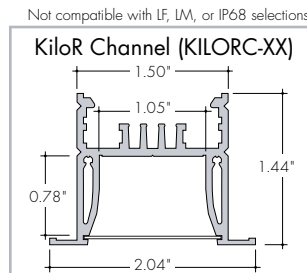

**C** 85% **F** 75%

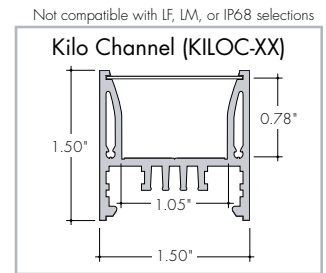

**C** 85% **F** 75%

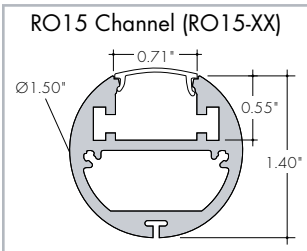

**C** 65% **F** 41%

**Discontinued Extrusion Reference Link**

<https://www.luminii.com/media/4351/extrusion-update-02.pdf>

## Power supply

See fixture and power supply instructions & spec sheet for wiring information. Dimming possible in select models - view Luminii website for list of compatible dimmers.

### Non-Dimming Power Supply

MODEL	POWER	OUTPUT	DIMMING	LOCATION
<b>PSV</b>	<b>96</b>	<b>24</b>	<b>U2ND</b>	<b>D</b>

PSV - PSV Series    96 - 96 Watt    24 - 24 VDC    U2ND - Non Dimming    D - Damp

MODELS	96W
<b>A Length</b>	14.40"
<b>B Width</b>	5.20"
<b>Depth</b>	2.60"

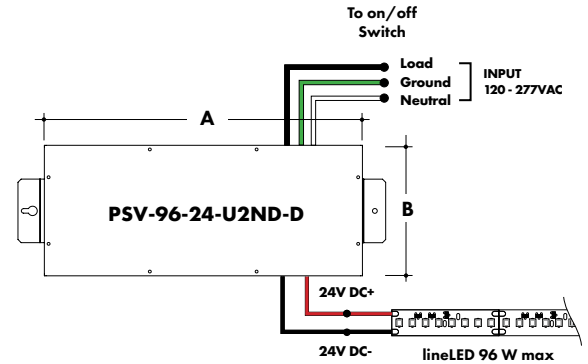

### DMX Dimming Power Supplies

MODEL	POWER	OUTPUT
<b>PSDMX</b>	<b>96</b>	<b>24</b>

PSDMX - DMX Power Supply    96 - 96 Watt    24 - 24 VDC  
 3X96 - 3 X 96 Watt

Features eldoLED's LINEARdrive configurable dimmable drivers

MODELS	96W	3X96
<b>A Length</b>	14.40"	15.75"
<b>B Width</b>	5.20"	6.62"
<b>Depth</b>	2.60"	4.95"

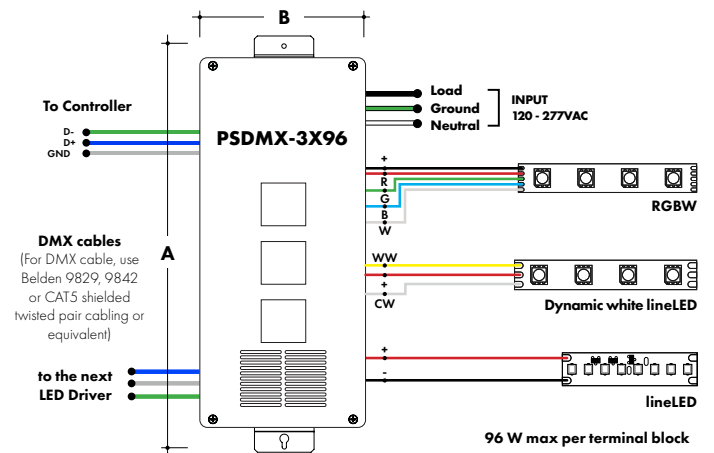
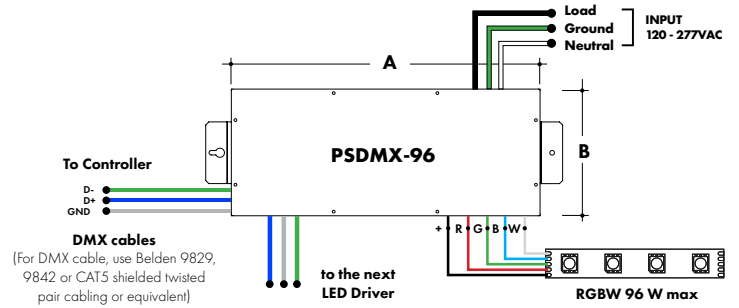

## DMX-3Z-RGBW

RGBW LED 1 or 3 Zone Controller

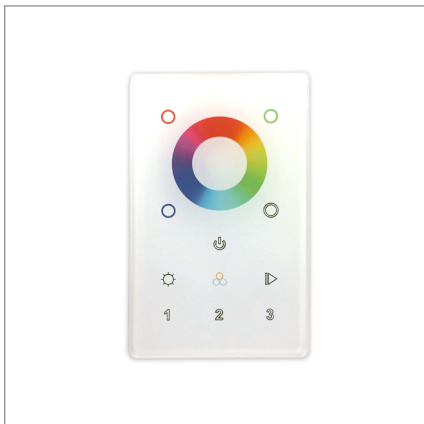

ORDERING CODE

MODEL	ZONES	COLOR
<b>DMX</b>	<b>3Z</b>	<b>RGBW</b>

DMX - DMX Controller  
3Z - Three Zone  
1Z - One Zone  
RGBW - Red, Green, Blue, & White

DMX /Wireless RGB-W wall-mount controller controls DMX lighting fixtures, wireless control of RGB-W lighting fixture or use both simultaneously. Fits in any standard US switch box. Includes all the outputs in the back of the controller.

Control brightness levels with a single touch, personalize and memorize 3 different scenes, and even create 3 variations of white.

### Features

- 2 in 1 in-Wall Controller: DMX Control or Wireless RGB-W
- 65,000 Color Options, Dimming and Speed Control
- Memory Function
- 50 Foot Wireless Range
- Easily Fits Standard US Switch Boxes
- Touch Sensitive Glass Surface
- Includes 10 Built in Programs, or Create and Play Your Own

### Operating voltage

12 - 24V DC

### Color parameters

- Brightness
- Saturation
- Primary colors
- Fading
- Color changing speed

## Touch DMX Controller

Touchscreen digital LED controller

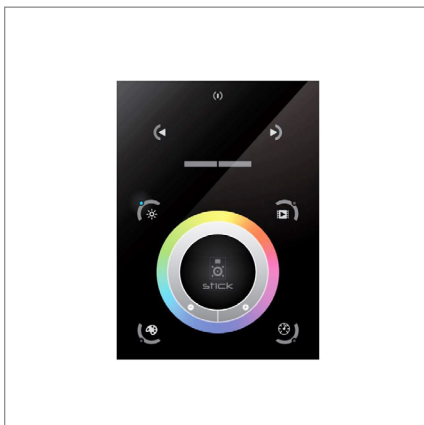

ORDERING CODE

MODEL

**TSDMX-E**

TSDMX-E - Touchscreen DMX controller

Programmable advanced DMX512 lighting controller featuring a touch-screen interface. Operates as stand alone controller or integrated with most architectural lighting control systems. Can controller endless DMX512 enabled devices.

Mounts to standard single or dual gang wall box with the included power supply inside the junction box. Terminal block design for power and data connections.

### Features

- Sleek glass design which sits 0.43" from the wall
- Graphical color display to show selected environment
- Color/dimmer/speed palette
- Color temperature mixing
- Touch sensitive buttons. No mechanical parts
- Touch sensitive wheel allows for accurate color selection
- Multi-zone microSD memory
- Multi-room control with 500 scenes, 10 zones
- 1024 DMX channels. Control 340 RGB fixtures
- USB & Ethernet connectivity for programming and control

### Power supply

7 VDC (included)

### Programmability

PC, Mac, Tablet, Smartphone

### Output signal

DMX512 (1024 channels)

### Color parameters

- Brightness
- Saturation
- Speed of color changing sequence
- Fading / dimming / brightness

## DMX decoder

DMX signal to RGBW decoder (required to operate DMX controller)



Translates controller DMX512 programs for RGB and white LED strips.

Unique DMX address for the decoder can be set easily and displayed by the numeric display on the case. Changing and resetting the DMX address requires manual input.

Use power repeater to expand output.

### Operating voltage

12-36 VDC

### Power capacity

up to 96W at 24V

### Operating temperature range

from -4°F to +122°F in case

ORDERING CODE

MODEL

**DDMX-RGBW**

DDMX-RGBW - DMX decoder