

## Features

LineLED 60X2 Tunable White Series Wet Double Row is a small profile high performance LED strip for IP65, IP67, and IP68 wet rated installations. This Tunable White LED series offers a wide CCT range to create the perfect ambiance in real time. From bright white encouraging wakefulness, to warm amber sunsetting into relaxation, LineLED 60X2 can transform any environment to match the natural human circadian rhythm. Industry-best color consistency with single-binned LEDs, 120 LEDs per foot. This High Color Quality LED strip boasts CRIs and R9 values up to 97. The durable but flexible product features heavier copper weight for improved heat dissipation and reduced voltage drop.



### Mounting

LED strip is equipped with 3M™ self-adhesive tape.

### Applications

Outdoor and wet locations - cove lighting, architectural accent, handrail, wet bars.

### Approvals

IP65, IP67, and IP68 rated

### Operating voltage

24 VDC

### Average Life (L70)

50,000 hours

### Warranty

3 years



## Technical Information

TYPE	LLTW60X2WET-T	
OUTPUT OPTIONS	HO (19K-35K)	HO (27K-65K)
Lumens Output (all channels full on)	478 lm/ft (29K)	612 lm/ft (44K)
Average Power Consumption (for a 4' section)	7.3 W/ft	7.3 W/ft
Efficacy(all on)	65 lm/W	84 lm/W
Cutting Increment (in)	1.41"	
Pitch Length	0.2"	
Max Run Length (in series)	26 ft	26 ft
Dimensions	0.71"W x 0.24" H	

CCT	TM-30			
	CRI	R <sub>f</sub>	R <sub>g</sub>	R <sub>9</sub>
1900K	97	94	98	95
2700K	98	96	101	91
2900K	98	96	102	94
3500K	97	94	105	97
4400K	97	91	101	97
6500K	92	88	97	64

## Section Start/End Options

### SL65

72" Soldered Leads, IP65 rated

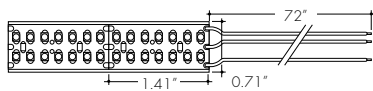

### SL68

72" Soldered Leads, IP68 rated

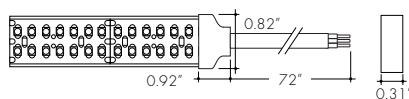

### LM

Male Quick Connect End, IP67 rated

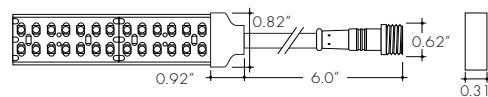

### LF

Female Quick Connect End, IP67 rated

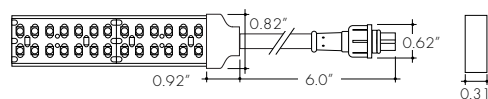

### NC

No Connector

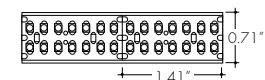

IP65 rated when used with SL65 selection



IP68 rated when used with SL68 selection  
IP67 rated when used with LM or LF selection

## Ordering code

MODEL	OUTPUT	CCT	SECTION START <sup>1</sup>	SECTION END <sup>1</sup>	LENGTH
LLTW60X2WET-T-LineLED Double Row LLTW60X2 Wet	HO-High	19K-35K-1900K-3500K 27K-65K-2700K-6500K	SL65-IP65 Soldered lead wires (72") SL68-IP68 Soldered lead wires (72") LF-IP67 Female Quick Connect LM-IP67 Male Quick Connect NC-No Connector	SL65-IP65 Soldered lead wires (72") SL68-IP68 Soldered lead wires (72") LF-IP67 Female Quick Connect LM-IP67 Male Quick Connect NC-No Connector	Ordered in one foot increments. See chart above for max run length.

<sup>1</sup>- IP rating of strip is equal to the lowest IP rating of section start and end options.

Accessories

**LVSP-WET**

Splice box: wet rated, low voltage, gray

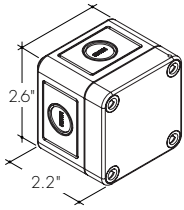

**LVSP-WET-CM**

Splice box connector, low voltage, gray

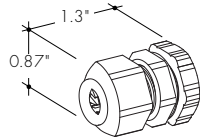

**CL2**

Mounting clip

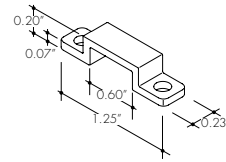

**LL.ZIP**

Cable/Wire Strain Relief Clip

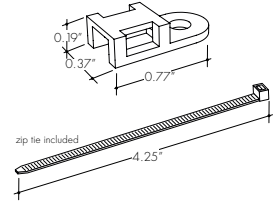

Recommended every 12" when LineLED strip is facing down

## Power Consumption

Tested at full power with PDC Series power supplies.

### LLTW60X2-WET-T-HO

Nominal Length	W/ft	Total Wattage
<b>1</b>	7.8	8.4
<b>2</b>	7.9	15.8
<b>3</b>	6.7	20.6
<b>4</b>	6.7	26.6
<b>5</b>	6.6	32.9
<b>6</b>	6.6	39.9
<b>7</b>	6.5	45.4
<b>8</b>	6.3	50.0
<b>9</b>	6.1	55.2
<b>10</b>	6.1	61.1
<b>11</b>	5.9	65.1
<b>12</b>	5.6	67.1
<b>13</b>	5.4	69.7
<b>14</b>	5.3	73.3
<b>15</b>	5.0	74.6
<b>16</b>	4.9	78.3
<b>17</b>	4.7	79.9
<b>18</b>	4.6	82.3
<b>19</b>	4.4	83.9
<b>20</b>	4.2	84.7
<b>21</b>	4.1	87.0
<b>22</b>	4.0	88.4
<b>23</b>	3.9	89.2
<b>24</b>	3.8	90.5
<b>25</b>	3.6	90.5
<b>26</b>	3.5	91.7

## Voltage Drop Calculator

The below chart assumes nominal voltage of 24 Volts and a Voltage Drop Allowance of 3% through the wire

Wattage [W]	Maximum Wire Length From Power Supply to Start of Run [ft]						
	12 AWG	14 AWG	16 AWG	18 AWG	20 AWG	22 AWG	24 AWG
<b>5</b>	1088.2	684.4	430.3	270.6	170.2	107.1	67.3
<b>10</b>	544.1	342.2	215.1	135.3	85.1	53.5	33.7
<b>15</b>	362.7	228.1	143.4	90.2	56.7	35.7	22.4
<b>20</b>	272.0	171.1	107.6	67.7	42.6	26.8	16.8
<b>25</b>	217.6	136.9	86.1	54.1	34.0	21.4	13.5
<b>30</b>	181.4	114.1	71.7	45.1	28.4	17.8	11.2
<b>35</b>	155.5	97.8	61.5	38.7	24.3	15.3	9.6
<b>40</b>	136.0	85.5	53.8	33.8	21.3	13.4	8.4
<b>45</b>	120.9	76.0	47.8	30.1	18.9	11.9	7.5
<b>50</b>	108.8	68.4	43.0	27.1	17.0	10.7	6.7
<b>55</b>	98.9	62.2	39.1	24.6	15.5	9.7	6.1
<b>60</b>	90.7	57.0	35.9	22.6	14.2	8.9	5.6
<b>65</b>	83.7	52.6	33.1	20.8	13.1	8.2	5.2
<b>70</b>	77.7	48.9	30.7	19.3	12.2	7.6	4.8
<b>75</b>	72.5	45.6	28.7	18.0	11.3	7.1	4.5
<b>80</b>	68.0	42.8	26.9	16.9	10.6	6.7	4.2
<b>85</b>	64.0	40.3	25.3	15.9	10.0	6.3	4.0
<b>90</b>	60.5	38.0	23.9	15.0	9.5	5.9	3.7
<b>96</b>	56.7	35.6	22.4	14.1	8.9	5.6	3.5

## Power Supplies

See fixture and power supply instructions & spec sheet for wiring information. Dimming possible in select models - view Luminii website for list of compatible dimmers.

### Ordering Code DALI2 Dimming Power Supplies 0.1% 120VAC - 277VAC

MODEL	INPUT CONTROL	ENVIRONMENT	WATTAGE	OUTPUT	OUTPUT CONTROL
PS - Power Supply, 120-277VAC	DALI-DT8 - DALI DT8 Tunable White (0.1%)	D-Dry	96-96 Watts	24-24 VDC	PWM - Pulse Width Modulation

MODELS	96W
Length	14.40"
Width	5.20"
Depth	2.60"

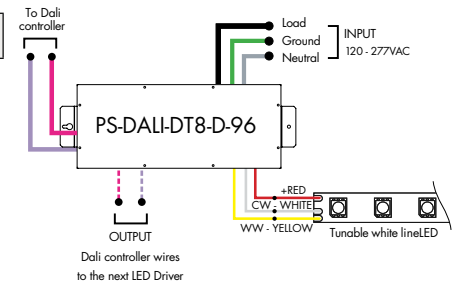

### Athena DALI2-DT8 LED Driver

MODEL	INPUT CONTROL	ENVIRONMENT	WATTAGE	OUTPUT	FEATURE
PS - Power Supply, 120-277VAC	DALI-DT8 - DALI DT8 Tunable White	D-Dry	96-96 W	24-24 VDC	AWNDR - Athena

MODELS	96W
Length	14.40"
Width	5.20"
Depth	2.60"

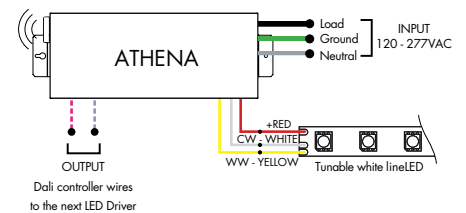

### Ordering Code VintageDim® 0 - 10V Dimming Power Supplies 120VAC - 277VAC

MODEL	INPUT CONTROL	ENVIRONMENT	WATTAGE	OUTPUT
PS - Power Supply, 120-277VAC	010V-WD - 0-10V Dimming, Standard Warm Dim Curve (with Tunable White LED) 010V-TW - 0-10V Dimming, Two Channel Control, Brightness and CCT1-CCT2 Ratio 010V-2CH - 0-10V Dimming, Two Channel Control, LED1 Brightness and LED2 Brightness 010V-WDX - 0-10V Dimming, Customizable Warm Dim Curve (with Tunable White LED) 010V-2CHX - 0-10V Dimming, Two Channel Control, Customizable Brightness and CCT1-CCT2 Ratio	D-Dry	96-96 Watts 3X96 - 3x96 Watts <sup>1</sup>	24-24 VDC

<sup>1</sup> - 3x96 is only available with input control options 010V-WD and 010V-TW  
<sup>2</sup> - Athena only available on 96 watts option

MODELS	96W	3X96
Length	14.40"	15.00"
Width	5.20"	6.62"
Depth	2.60"	4.56"

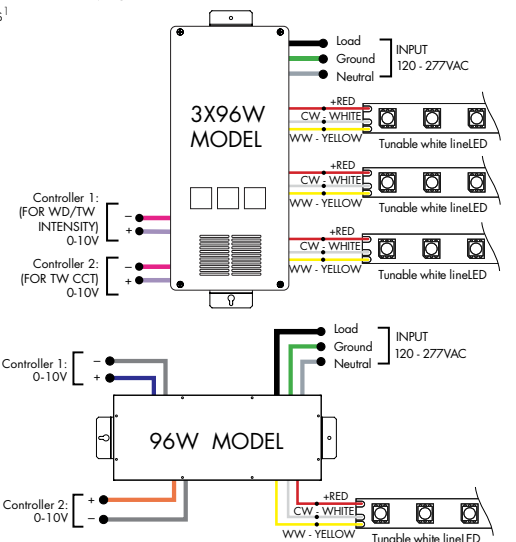

## Power Supplies

See fixture and power supply instructions & spec sheet for wiring information. Dimming possible in select models - view Luminii website for list of compatible dimmers.

### Athena 0-10V Warm Dim LED Driver

MODEL	INPUT CONTROL	ENVIRONMENT	WATTAGE	OUTPUT	FEATURE
PS-Power Supply, 120-277VAC	010V-WD-0-10V Dimming, Standard Warm Dim Curve (with Dynamic White LED)	D-Dry	96-96 W	24-24 VDC	AWNDR-Athena

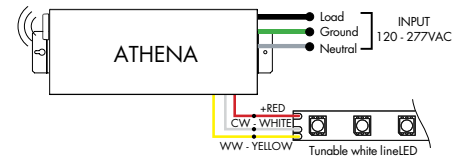

MODELS	96W
Length	14.40"
Width	5.20"
Depth	2.60"

### Athena 0-10V Two Channel LED Driver

MODEL	INPUT CONTROL	ENVIRONMENT	WATTAGE	OUTPUT	FEATURE
PS-Power Supply, 120-277VAC	010V-2CH-0-10V Dimming Two Channel Control, LED1 Brightness and LED2 Brightness	D-Dry	96-96 W	24-24 VDC	AWNDR-Athena

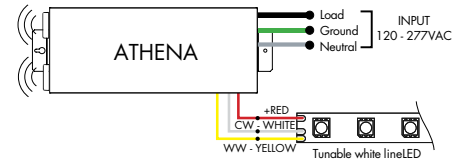

MODELS	96W
Length	14.40"
Width	5.20"
Depth	2.60"

## Ordering Code DMX Dimming Power Supplies 0.1% 120VAC - 277VAC Requires Controller

MODEL	INPUT CONTROL	ENVIRONMENT	WATTAGE	OUTPUT
PS-Power Supply, 120-277VAC	DMX-DMX (0.1%)	D-Dry	96-96 Watts 3X96-3X96 Watts	24-24 VDC

MODELS	96W	3X96
Length	14.40"	15.00"
Width	5.20"	6.62"
Depth	2.60"	4.56"

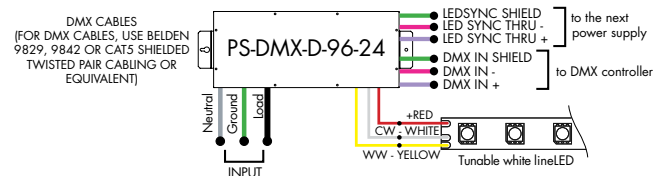
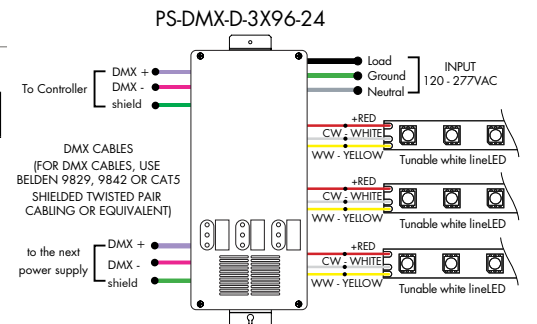

## Controllers and Decoders



MODEL

**DTW-MC**

DTW-MC - Tunable White controller

Tunable White wall-mount controller controls lighting fixtures, wireless control of TW lighting fixture. Fits in any standard US switch box. Includes all the outputs in the back of the controller.

### Features

- Switch & dimming control function, control range > 20M.
- Smooth transition between light levels.
- Separately operate dimming and color temperature functions.
- Able to control 1 zone with endless receivers. Each receiver can maximally be controlled by 8 remotes.
- Power, temperature color and dimming functions operated by push button after receivers are connected.

### Operating Voltage

3V DC battery

### Color Parameters

- Brightness
- Saturation
- Fading



MODEL

**TW-DMX**

TW-DMX - DMX controller

Tunable White DMX wall-mount controller is a fully touch sensitive controller designed in accordance with standard protocol DMX512. Offers fast and accurate color temperature adjustment and brightness dimming of natural white, warm white and cold white. Designed with a touch color wheel, the DMX512 controller can adjust color temperature and brightness for all white LEDs smoothly and accurately. The DMX controller can control 1 zone with endless decoders.

### Features

- 1 zone
- 6 color scenes
- DMX Control
- Touch Sensitive Glass Surface
- Dimming and Speed Control
- Memory Function
- Easily Fits Standard US Switch Boxes

### Operating Voltage

12 - 24V DC

### Color Parameters

- Brightness
- Saturation
- Primary colors
- Fading
- Color changing speed



MODEL

**SLD-DIMTW**

SLD-DIMTW - Tunable white LED dimming module

The SLD DimTW is a constant voltage warm dimming LED dimming module. The unique dimming module accepts 0-10V control and mimics a smooth, incandescent dimming curve.

### Features

- Flicker free 0-100% dimming
- High efficiency up to 97%
- High precision dimming ratio:>1:1000
- Fully isolated plastic housing
- Comply with EN55015 and FCC part 15 without additional input filter and capacitors
- compact size, high reliability
- 3 years warranty

### Operating Voltage

8-48 VDC

## Controllers and Decoders



MODEL

**RGBW-RC-R**

RGBW-RC-R - RGBW receiver

The RGBW receiver is easily paired with controller by the click of a button. Receiver can be reset to factory settings at any time.

Each receiver can store one static RGB color, one color sequence, and one brightness setting for the white LED strip. Receivers assigned to the same scene within the same zone will have the same LED static color and color sequence.

**Operating Voltage**  
12-36 VDC

**Power Capacity**  
up to 96W at 24V

**Operating Temperature Range**  
from -4°F to +122°F in case



MODEL

**RGBW-SR**

RGBW-SR - RGBW signal repeater

Extends identical signal when connected in series to an RGBW LED control system. The RGBW signal repeater works with Luminii RGB and RGBW controllers, receivers, and decoders.

RGBW signal can be extended indefinitely when adequate power supply (not included) is connected to the system.

**Operating Voltage**  
12-36 VDC

**Power Capacity**  
up to 96W at 24V

**Operating Temperature Range**  
from -4°F to +122°F in case



MODEL

**DDMX-RGBW**

DDMX-RGBW - DMX decoder

Translates controller DMX512 programs for RGB and white LED strips.

Unique DMX address for the decoder can be set easily and displayed by the numeric display on the case. Changing and resetting the DMX address requires manual input.

Use power repeater to expand output.

**Operating Voltage**  
12-36 VDC

**Power Capacity**  
up to 96W at 24V

**Operating Temperature Range**  
from -4°F to +122°F in case



## Controllers and Decoders

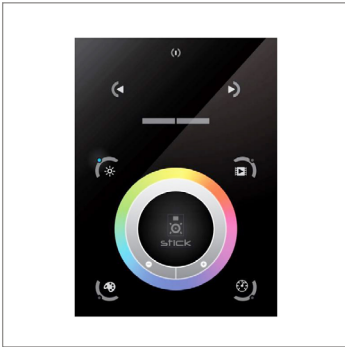

MODEL

**TSDMX-E**

TSDMX-E - Touchscreen DMX controller

Programmable advanced DMX512 lighting controller featuring a touch-screen interface. Operates as stand alone controller or integrated with most architectural lighting control systems. Can controller endless DMX512 enabled devices.

Mounts to standard single or dual gang wall box with the included power supply inside the junction box. Terminal block design for power and data connections.

### Features

- Sleek glass design which sits 0.43" from the wall
- Graphical color display to show selected environment
- Color/dimmer/speed palette
- Color temperature mixing
- Touch sensitive buttons. No mechanical parts
- Touch sensitive wheel allows for accurate color selection
- Multi-zone microSD memory
- Multi-room control with 500 scenes, 10 zones
- 1024 DMX channels. Control 340 RGB fixtures
- USB & Ethernet connectivity for programming and control

### Power Supply

7 VDC (included)

### Programmability

PC, Mac, Tablet, Smartphone

### Output Signal

DMX512 (1024 channels)

### Color Parameters

- Brightness
- Saturation
- Speed of color changing sequence
- Fading / dimming / brightness



MODEL

**DDMX-5CH-RDM-PRO**

DDMX-5CH-RDM-PRO-DMX512 Decoder

DMX512 decoder with RDM functionality features 5 PWM output channels with common anode. High PWM output frequency range allows the product to be used in HD video conferencing spaces. All DMX products to be installed per DMX512 Standard.

### Power

96 Watt

### Inputs

RJ45, XLR-5Pin, Terminal Block

### DMX Channels

1 to 5 settable

### PWM Output Resolution Ratio

8 or 16 bit

### PWM Output Frequency

500Hz - 30KHz

### Output Dimming Curve Gamma Value

0.1 ~ 9.9



MODEL

**RGBW-WI-R**

RGBW-WI-R - WIFI generator

RGBW-WI-R creates a local network that enables any electronic device (phone, tablet, etc.) to control the RGB/WV strip connected to a RGBW-RC-R receiver.

The control functions are achieved through a free application download for Android and iOS devices called REALCOLOR.

### Operating Voltage

12-36 VDC

### Power Supply

PI-130-24 (included)

### Operating Temperature Range

from -4°F to +122°F in case