

LineLED 24V - Installation Instructions

Models LLRGBW36-XX



7777 Merrimac Ave
Niles, IL 60714
T 224.333.6033
F 224.757.7557
info@luminii.com
www.luminii.com

REV.0.5
10082024

1 / 2

Please read all instructions prior to installation and keep for future reference!

1. PRODUCT SHOULD BE INSTALLED BY A QUALIFIED ELECTRICIAN
2. ENSURE POWER IS OFF AT FUSE BOX PRIOR TO INSTALLATION TO PREVENT ELECTRICAL SHOCK
3. USE ONLY WITH CLASS 2 POWER UNIT
4. SUITABLE FOR DAMP LOCATIONS
5. FOR UNDER CABINET OR SHELF MOUNT
6. CONFORMS TO UL STD 2108. CERTIFIED TO CSA STD NO. 250.0.

ATTENTION: ALWAYS TEST LLRGBW36 BEFORE INSTALLING. CONNECT LLRGBW36 TO POWER SUPPLY TO ENSURE IT IS WORKING PROPERLY AND NO DAMAGE HAS OCCURRED DURING SHIPPING.

1

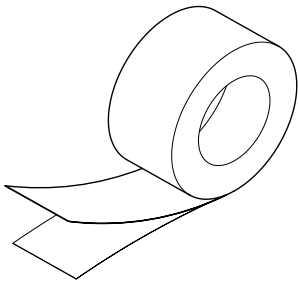

1.1 Clean area thoroughly where tape will be installed.

For rough surface installations, it is recommended to apply a layer of Aluminum tape or similar material prior to tape application.

2

NOTE : Avoid bending the LLRGBW36 in sharp horizontal angles which may damage the LEDs

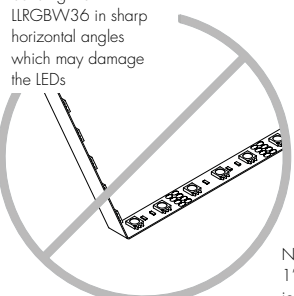

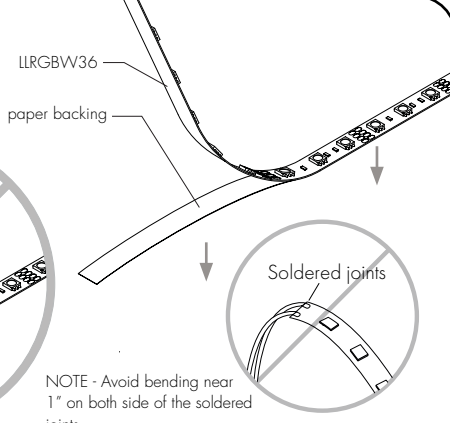

NOTE - Avoid bending near 1" on both side of the soldered joints.

2.1 Remove the paper backing from the LLRGBW36 and firmly press down making sure there are no air bubbles that can cause surface irregularities. Do not remove the adhesive, removing the adhesive may cause arcing of the Line LED tape.

3

3.1 Place the strain relief in desired place. Make sure it is 3" away from the end of the strip.

3.2 Slide the ziptie through strain relief opening.

3.3 Lay wire lead on top of strain relief.

3.4 Tighten zip tie around lead wire. Cut off excess zip tie.

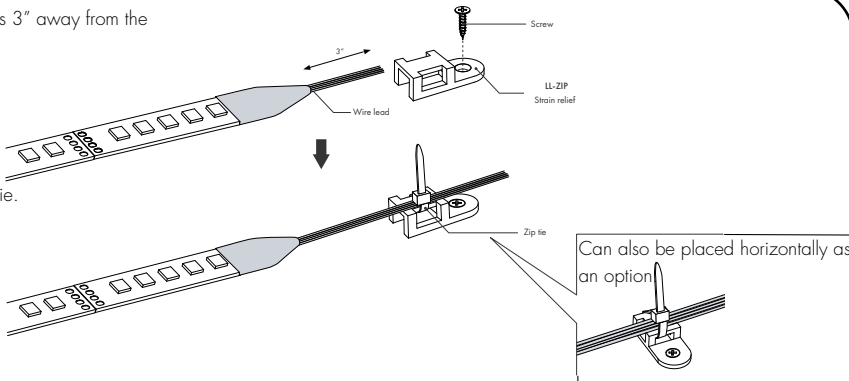

4

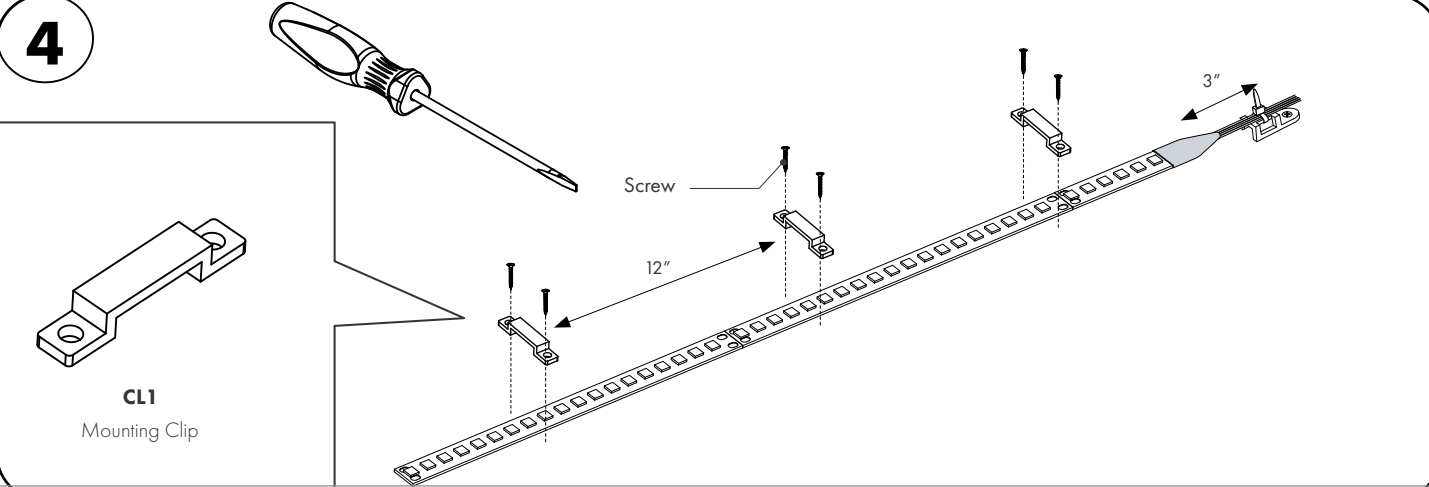

CL1
Mounting Clip

*LUMINII RESERVES THE RIGHTS TO CHANGE SPECIFICATION & INSTRUCTION WITHOUT NOTICE

LineLED 24V - Installation Instructions

Models LLRGBW36-XX



7777 Merrimac Ave
Niles, IL 60714
T 224.333.6033
F 224.757.7557
info@luminii.com
www.luminii.com

REVO.5
10082024

2 / 2

Please read all instructions prior to installation and keep for future reference!

1. PRODUCT SHOULD BE INSTALLED BY A QUALIFIED ELECTRICIAN
2. ENSURE POWER IS OFF AT FUSE BOX PRIOR TO INSTALLATION TO PREVENT ELECTRICAL SHOCK
3. USE ONLY WITH CLASS 2 POWER UNIT
4. SUITABLE FOR DAMP LOCATIONS
5. FOR UNDER CABINET OR SHELF MOUNT
6. CONFORMS TO UL STD 2108. CERTIFIED TO CSA STD NO. 250.0.

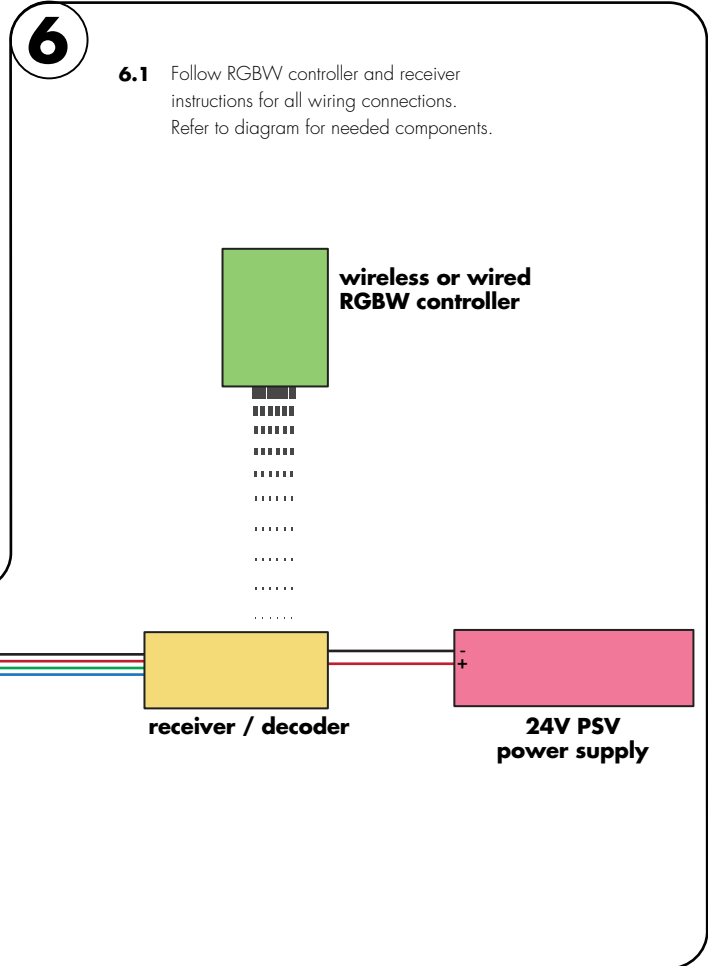
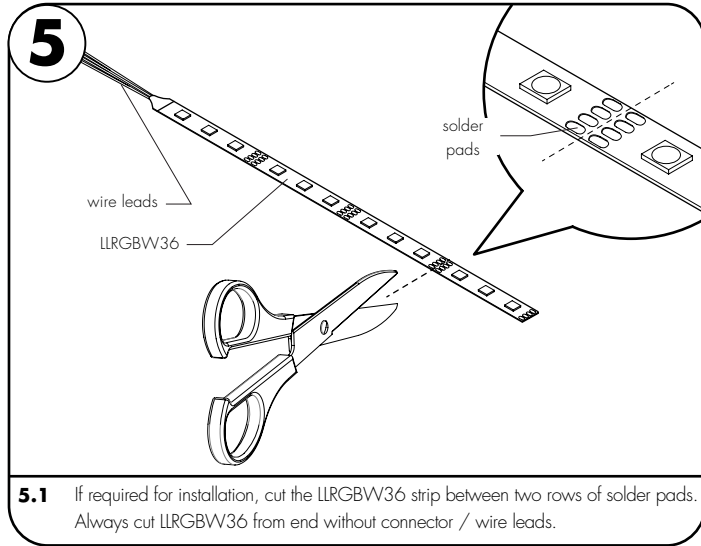

Power Supply Wiring Diagram

Note: Prior to installation all 24VDC wires must be present near fixture. Refer to the power supply installation instructions for additional information.



RGB/RGBW
Wiring Diagram PDF