

LETO 21

DOUBLE

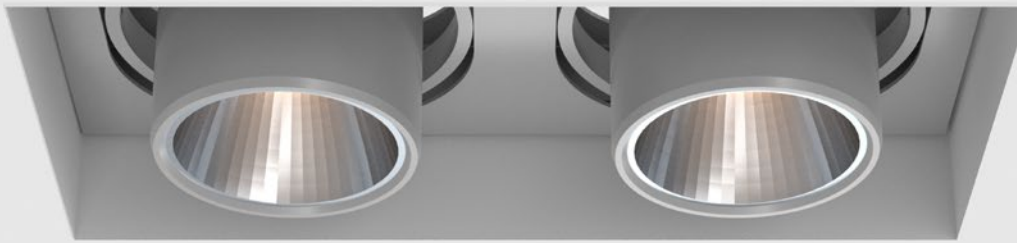

Leto 21 Double - Recessed Adjustable downlight. LETO 21 Double is a rectangle trimless recessed LED fixture. It is fully adjustable to 30°, designed to be architecturally pleasing with trimless application. It can be used for general lighting, or to highlight specific design areas.

Ordering Code

Fixture	602						
	1	2	3	4	5	6	
Driver		602			--	--	--
	1	2	3	4	5	6	7

Product Specifications

SAMPLE: Fixture **602 - A90 - 618 - 27 - 07 - 01** | Driver **915 - 602 - STD - 120 - A90 - 07 - 01**

1 - Model	2 - LED	3 - Optic	4 - CCT	5 - Lumen	6 - Finish	1 - Housing Style	2 - Model
602 · Leto 21 Double	A90 · 93+ CRI Accuracy	618 · 18° 630 · 30° 645 · 45° 660 · 60°	25 · 2500K 27 · 2700K 30 · 3000K 35 · 3500K 40 · 4000K 65 · 6500K	07 · 700 (7.5W) 10 · 1000 (10.8W) 15 · 1500 (16.7W) 20 · 2000 (22W) 30 · 3000 (33.7W) ^{*6} <i>Lumen and wattage per head</i>	01 · White 02 · Black 08 · Silver XX · Custom	915 · New Construction 920 · IC Housing ^{*7}	602 · Leto 21 Double

3 - Driver	Dim Level	Dim Level	4 - Line Voltage	5 - LED	6 - Lumen	7 - Finish
STD · Non Dimming	N/A	LUTES · Hilume Ecodigital ^{*3}	120 · 120V	Same as Fixture	Same as Fixture	Same as Fixture
LCS · 0 - 10 Volt Protocol	1%	LUT2W · 2 Wire for phase ^{*2/3}	277 · 277V			
DIM · Phase ^{*2}	10%	DMX · SENSO ^{*3}	347 · 347V ^{*5}			
ELDOLC · EldoLED 0 - 10 Volt ^{*3}	0.1%	EMG · Emergency Driver ^{*3/4/6/7}				
DALI · Dali Protocol ^{*3}	0.1%	CSMB · Casambi Wireless Control ^{*3/4}				

*1 Cannot exceed 1500lm per head

*2 120V only

*3 Requires remote housing

*4 Specified separately

*5 Not available with ELDO, Lutron or DMX

*6 Two drivers needed

*7 Only available with one head

Project : _____

Quantity : _____

Type : _____

Notes : _____

Photometrics

Senso's in-house photometric testing ensures that our lighting design can match your needs precisely. Our Goniophotometer and testing lab produces on-demand photometry files based on any specified fixture, including LM-79 Test reports, IES Files, and CRI/CCT measurements. See Sensolighting.com for more information.

**Full photometric Reports and IES files available for every configuration*

Color Metrics

TM 30-15

Our clients deserve the best information possible about their lighting choices. That's why Senso has invested in the Illuminating Engineering Society (IES) TM 30-15, a new system that measures an LED light source's color rendering properties. Using Senso's state-of-the-art goniophotometer, this method identifies the optimal light source for your project and helps evaluate the trade-offs between efficacy and color rendering. Senso can provide TM 30-15 data for all of our products.

**Full Color Metric Info Available at Sensolighting.com*

Light Engine

- Output:** up to 3000lm Per head
- High Efficacy:** up to 92 lumen/Watt
- Color Options (CCT):** 2500K, 2700K, 3000K, 3500K, 4000K or 6500K
- Color Consistency:** Range within a 3-MacAdam Ellipse
- Color rendering (CRI):** 93+ CRI & 50+ R9 Value

Driver and Power Consumption

- Dimming:** 1% dimming standard with 0.1% option
- Ripple:** Industry leading Low ripple
- Efficiency:** Power Factor >0.9
Efficiency over 85%
Class 2 output for safety

Lumen Option	700lm	1000lm	1500lm	2000lm	3000lm
Fixture Wattage	7.5W	10.8W	16.7W	22W	33.7W
Delivered Lumen	683lm	992lm	1474lm	1935lm	2798lm

Installation

- For new installations only
- Fully 30° angle adjustable spot, 360° rotation
- Simple connection between fixture and driver via quick connect
- Available for wet rated in single version.

Construction / Finish

- Custom finishes are available
- Cast Aluminum Trim and Steel Casing
- Made in Canada

Dimensions

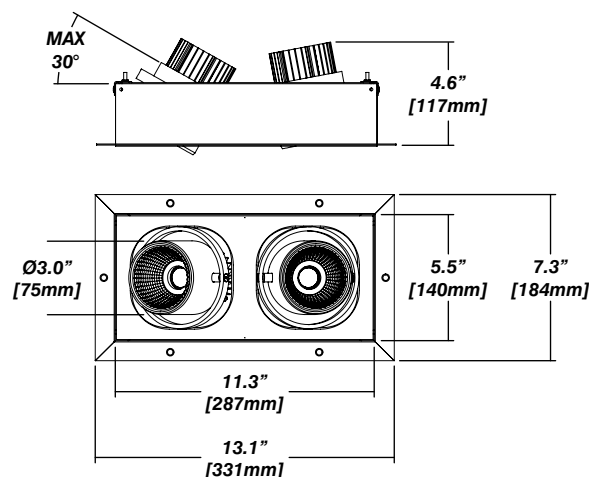
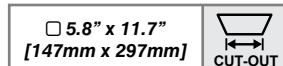

Reflector

Faceted Reflector

Senso metal spun reflectors for function, low glare and efficiency

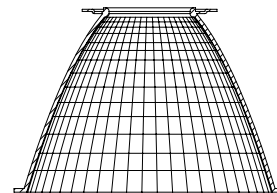

Housing Options

New Construction - 915

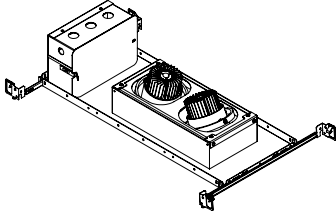

Dimension

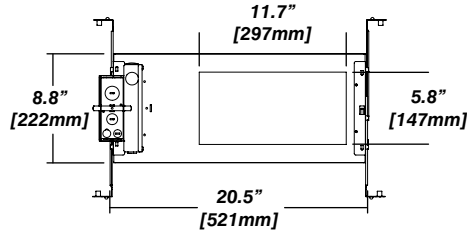

Included

- Plaster Frame**
 - Galvanized steel construction with cut-out to
- Bar hanger**
 - Length: from 14-3/16" to 26"
- Security wire**
 - Flexible aircraft cable, 12" long
 - Easy to clip snap body included

IC Housing - 920

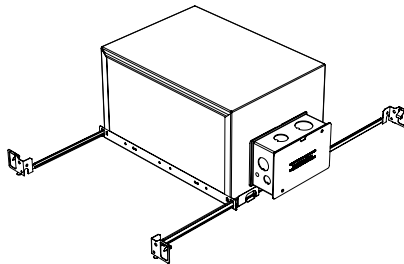

Dimension

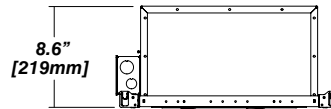
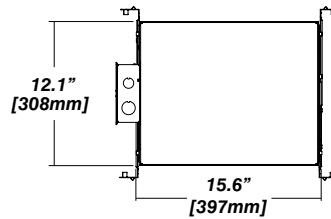

Included

- IC Housing**
 - Galvanized steel construction
 - Airtight
 - Includes gasketed junction box
- Plaster Frame**
 - Galvanized steel construction
- Bar hanger**
 - Length: from 14-3/16" to 26"

Note: use only with LED modules up to 1500lm