

**Features**

Kurba Large is a dot free direct view, highly versatile, energy efficient and flexible LED strip suitable for outdoor wet locations capable of horizontal/side bends and vertical/top bends with a 6" bending radius. The silicone material offers excellent heat, weather, UV, and solvent resistance and has a special coating to repel dust and dirt accumulation.

- Output Options**
  - 2-Wire Warm Dim gradually warms the color temperature as you dim down the brightness
  - Tunable White allows individual control of CCT and output
  - RGB options offer balanced output across the color gamut and a true white with RGBW
  - Smart Pixel offerings allow for infinite color combinations with cascading and chasing effects

**Average Life (L70)**

50,000 hours

**Approvals**

24VDC Class 2 wet listed, IP68

**Warranty**

3 years

**RoHS Declare.**

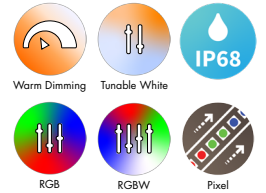

**Finish Options** (see page 2 for additional information)

**Base**  White

**Premium**  Black  Red  Green  Blue

**Technical Information**

Bending Direction	Horizontal					Vertical				
	Output	WD5950	TW4450	RGB2650	RGBW2650	SPI2650	WD5950	TW4450	RGB2650	RGBW2650
Light Output at 3000K	178 lm/ft	166 lm/ft	110 lm/ft	192 lm/ft	242 lm/ft	214 lm/ft	194 lm/ft	125 lm/ft	205 lm/ft	286 lm/ft
Average Power Consumption at 4'	3.66 W/ft	3.66 W/ft	3.66 W/ft	4.57 W/ft	6.71 W/ft	3.66 W/ft	3.66 W/ft	3.66 W/ft	4.57 W/ft	6.71 W/ft
Efficacy	49 lm/W	45 lm/W	30 lm/W	42 lm/W	36 lm/W	58 lm/W	53 lm/W	34 lm/W	45 lm/W	43 lm/W
Ordering Increment	2.46"	3.28"	3.28"	3.28"	3.28"	2.46"	3.28"	3.28"	3.28"	3.28"
Maximum Run Length (In Series)	26'	26'	26'	19'	16'	26'	26'	26'	19'	16'
Operating Temperature	-40°F to 131°F	-40°F to 131°F	-40°F to 131°F	-40°F to 113°F	-40°F to 113°F	-40°F to 131°F	-40°F to 131°F	-40°F to 131°F	-40°F to 113°F	-40°F to 113°F
Control/Dimming Protocol	Phase & 0-10V	0-10V, DMX	DMX	DMX	SPI Protocol UCS 2904	Phase & 0-10V	0-10V, DMX	DMX	DMX	SPI Protocol UCS 2904

**Constraints**

**Horizontal Bend Direction**

Bend LED in these positions only to avoid damage

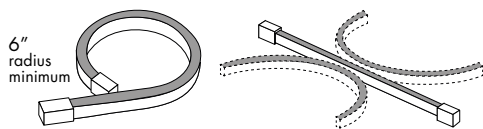

Illuminated surface shown in gray

**Horizontal Prohibited Bends**

Twisting or bending LED in these positions will cause damage

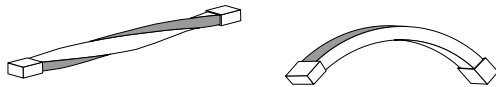

Illuminated surface shown in gray

Do not make sharp bends near the endcap

**Vertical Bend Direction**

Bend LED in these positions only to avoid damage

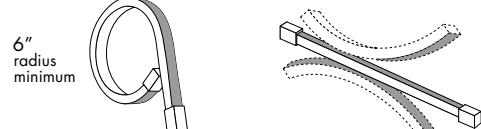

Illuminated surface shown in gray

**Vertical Prohibited Bends**

Twisting or bending LED in these positions will cause damage

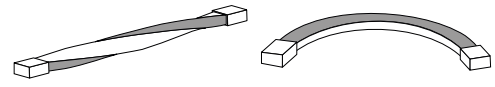

Illuminated surface shown in gray

Do not make sharp bends near the endcap

**Ordering Code**

MODEL	RATING	BEND DIRECTION	LENGTH	OUTPUT <sup>1,2</sup>	CCT	LENS	MOUNTING	FINISH <sup>4</sup>	FEED POSITION LEFT	FEED POSITION RIGHT
KBL - Kurba Large	W - Wet	HB - Horizontal Bending VB - Vertical Bending	SEE PCC CHART ON PAGES 6 - 10	WD5950 - Warm Dim, Standard Output	18K30K - 1800K-3000K	SF - Silicone Frosted BL - Black Lens <sup>3</sup>	NA - See Page 4 - 5 for orderable mounting accessories	WH - White BK - Black RED - Red GRN - Green BLU - Blue	INJECTION MOLD IME - End Feed 1 IMB - Back Feed 1 IMS - Side 1 Feed IMSB - Side 2 Feed <sup>5</sup> NPF - No Power Feed <sup>6</sup>	INJECTION MOLD IME - End Feed 1 IMB - Back Feed 1 IMS - Side 1 Feed IMSB - Side 2 Feed <sup>5</sup> NPF - No Power Feed <sup>6</sup>
				TW4450 - Tunable White, Standard Output	22K57K - 2200K-5700K 26K42K - 2600K-4200K <sup>2</sup>					
				RGB2650 - RGB, Standard Output	RGB - Red, Green, Blue					
				RGBW2650 - RGBW, Standard Output	RGB26K - RGB 2600K <sup>2</sup> RGB27K - RGB 2700K RGB30K - RGB 3000K RGB40K - RGB 4000K					

Feeds come with 118" wire leads

1 - Title 24 JA8 compliance achievable, contact factory for specific requests  
2 - Black Lens only available with 26K42K, RGB, and RGB26K CCT options

3 - BL - Black Lens can only be used with BK - Black Finish  
4 - Red, Green, and Blue finishes have a MOG of 350ft

5 - IMSB - Side 2 Feed not available with HB - Horizontal Bending  
6 - NPF/NPF for Feed Position 1&2 is not a valid configuration option

## Powerfeeds and Connectors

### Power Feed Position Options and Orientation

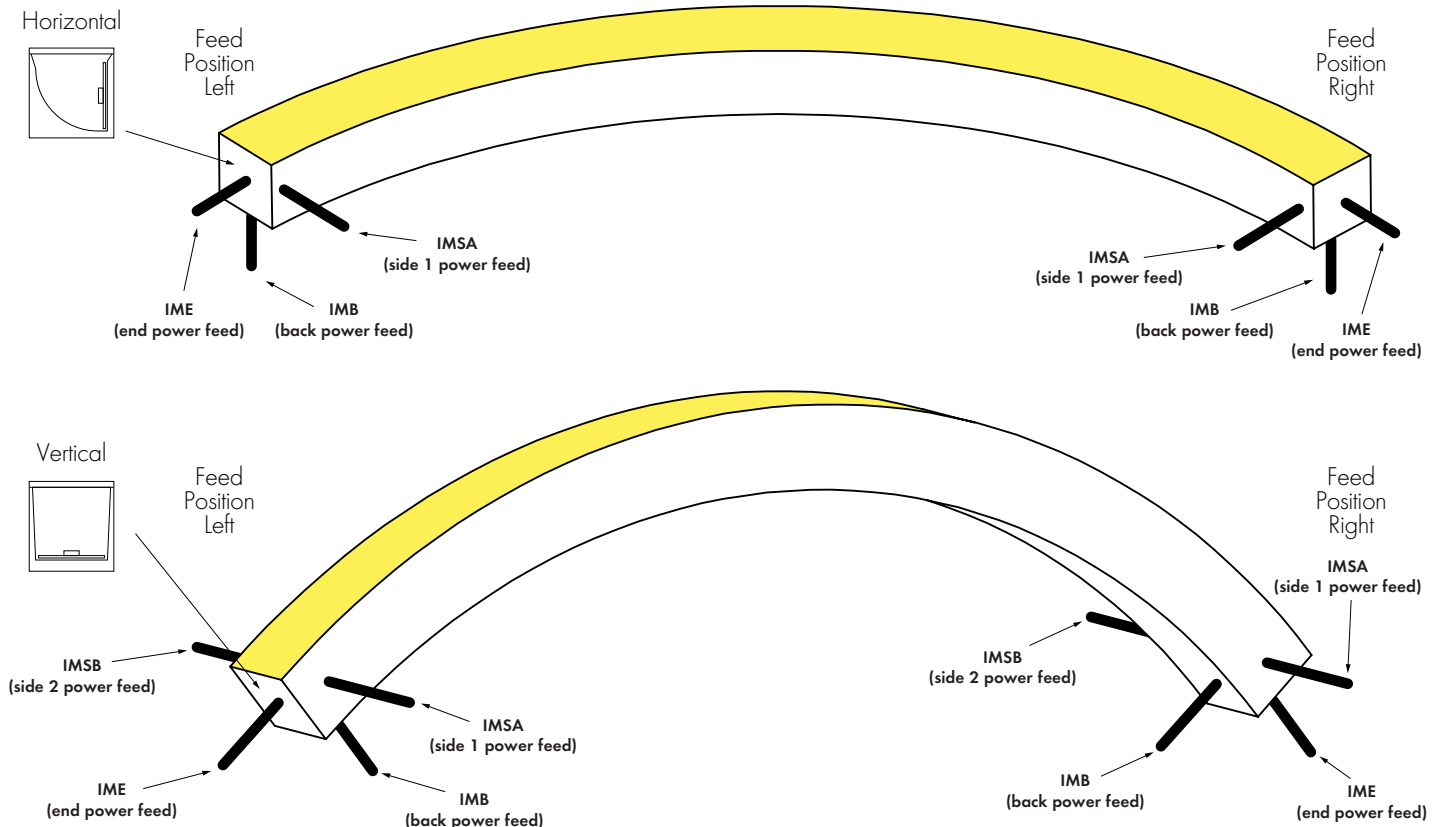

NOTE: IMSB - Side 2 Feed not available with HB - Horizontal Bending

### Linking and Extension Cable Options

#### END CONNECTOR

Injection-molded End Connector  
-IME

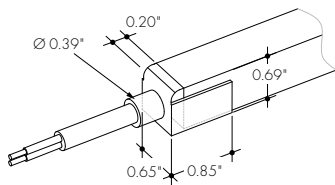

#### BACK CONNECTOR

Injection-molded Back Connector  
-IMB

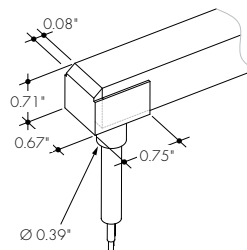

#### SIDE CONNECTOR

Injection-molded Side Connector  
-IMSA and -IMSB

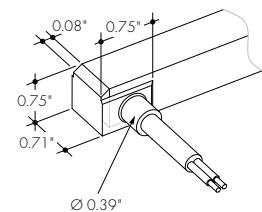

#### ENDCAP (NO CONNECTOR)

Injection-molded Cap (No Connector)  
-NPF

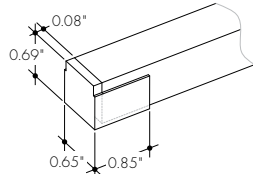

#### ANTI-WICKING FERRULE

Included on every power feed wire

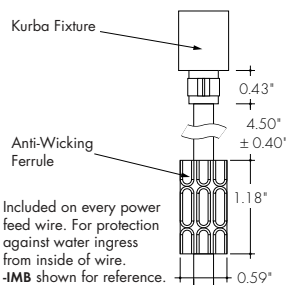

Included on every power feed wire. For protection against water ingress from inside of wire.  
-IMB shown for reference.

#### POWER FEED OPTIONS

WH/RED/GRN/BLU

BK



Warm Dim  
2 Conductor



Tunable White/Pixel  
3 Conductor



RGB  
4 Conductor



RGBW  
5 Conductor

**Product Dimensions**

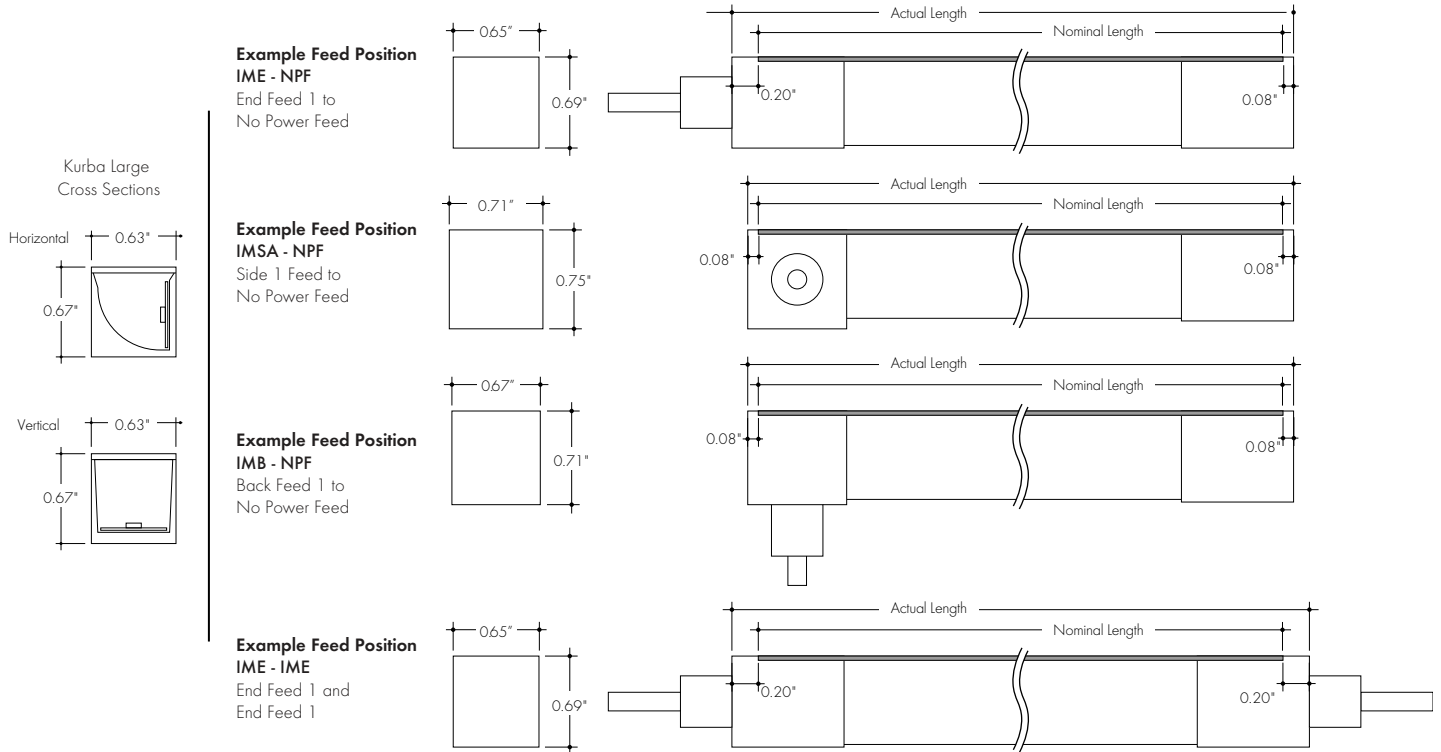

**Finish Options**

- A wide variety of finish options allowing complete customization of style and aesthetic.
- Red, Green, and Blue finishes have an minimum order quantity of 350ft

**White Base**

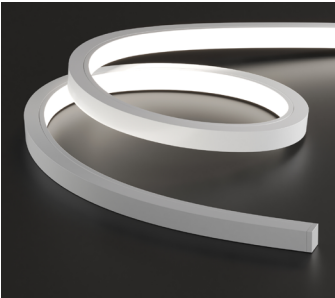

Kurba's base finish is a crisp white which brings a timeless, clean aesthetic that brightens and enhances any space

**Black Finish w/ Black Lens Premium**



Also available with a blackout aesthetic - the Black Lens paired with the Black Finish provides for a sleek, all black profile that keeps the strip concealed in the off-state.

**Red Premium**

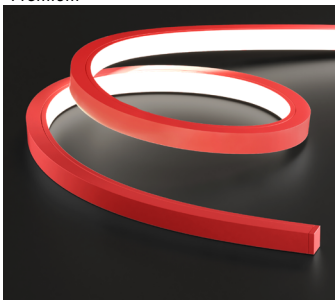

Red adds a bright and bold statement, perfect for creating a striking and dynamic ambiance with its vibrancy

**Green Premium**

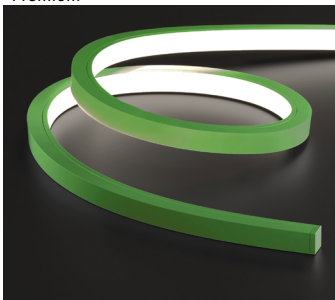

Green embraces a refreshing and natural feel, reminiscent of emerald green, add touch of tranquility and harmony to your space with this option

**Blue Premium**

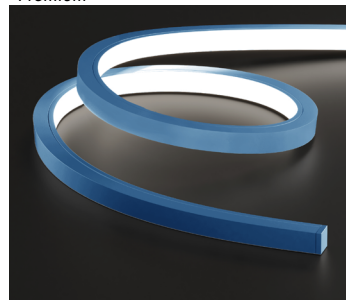

Blue evokes the serenity of the deep sea by combining vivid cobalt and azure tones.

## Light Transmission and Dotting

Output Options	Lens/Accessory					
	Silicone Frosted/ White Finish	Silicone Frosted/ Red Finish	Silicone Frosted/ Green Finish	Silicone Frosted/ Blue Finish	Silicone Frosted/ Black Finish	Black Lens/ Black Finish
WD59SO	ND	ND	ND	ND	ND	ND
TW44SO	ND	ND	ND	ND	ND	ND
RGB26SO	ND	ND	ND	ND	ND	ND
RGBW26SO	ND	ND	ND	ND	ND	ND
SPI26SO	ND	ND	ND	ND	ND	ND
<b>Transmission Percentage</b>	100%	80%	80%	80%	80%	17%

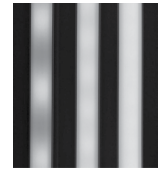

**CD** - Clear Dotting  
**SD** - Slight Dotting  
**ND** - No Dotting

## Mounting Accessories

### MC-KBL-SAP-SM-0.8-SA

KBL Mounting Channel, Serrated Aluminum Profile, Surface Mount, 0.8in, Silver Anodized

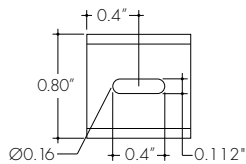
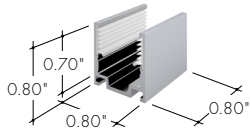

For use with light strip mounted to the ceiling. 1 recommended every 8 in.

### MC-KBL-SAP-SM-78-SA

KBL Mounting Channel, Serrated Aluminum Profile, Surface Mount, 78in, Silver Anodized

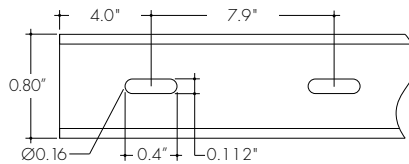
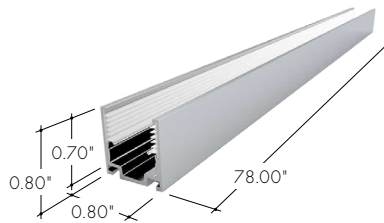

For use with light strip mounted to the ceiling.

### MC-KBL-FSAP-TR-78-SA

KBL Mounting Channel, Flanged Serrated Aluminum Profile, Trimmed Recessed Mount, 78in, Silver Anodized

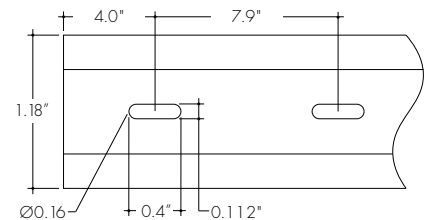
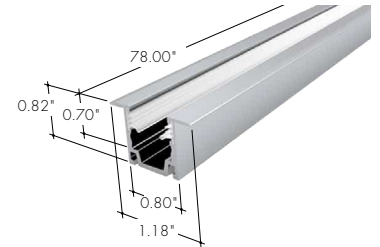

Flanged aluminum mounting channel providing grip. For use with light strip recessed into the ceiling.

### MC-KBL-RCWY-SM-78-SA

KBL Mounting Channel, Raceway, Surface Mount, 78in, Silver Anodized

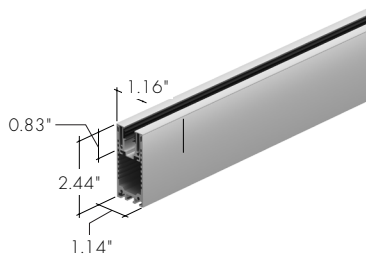

Raceway channel allows for hidden cable management and is a superb option where tidiness is required.  
**NOTE:** Compatible with **IMB** - Back Feed only

### MC-KBL-BSSP-3D-SM-34-SS

KBL Mounting Channel, Bendable Stainless Steel Profile, 3D Bending, Surface Mount, 34in, Stainless Steel

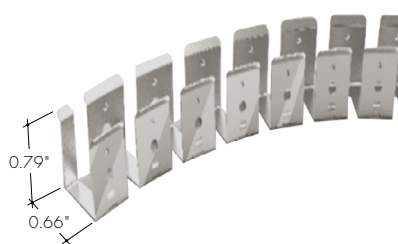

For use with light strip mounted to the ceiling.

### MC-KBL-BSAP-HB-SM-38-SA

KBL Mounting Channel, Bendable Serrated Aluminum Profile, Horizontal Bending, Surface Mount, 38in, Silver Anodized

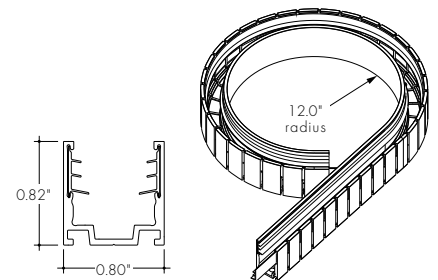

For use with light strip mounted to the ceiling.  
**NOTE:** Not Available on Vertical Bending.

**Mounting Accessories and Optional Connectors**

**MC-KBL-BANP-3D-SM-39-XX**

KBL Mounting Channel, Bendable Silicone Profile, 3D Bending, Surface Mount, 39", 6" bending radius

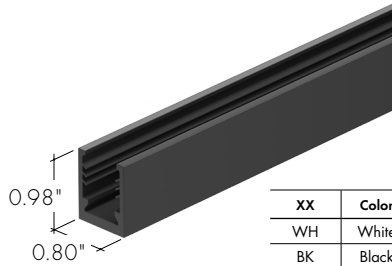

XX	Color
WH	White
BK	Black

**LVSP-WET**

Splice box: wet rated, low voltage, gray

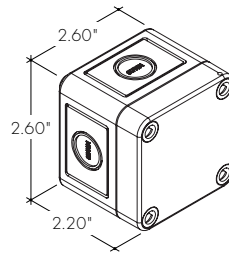

**LVSP-WET-CM**

Connector for splice box, low voltage for cable management, gray

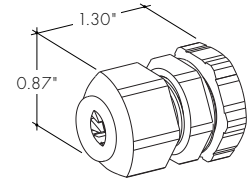

### WD59SO | Power Consumption Per Fixture Length

Based on operation with PDCU series of power supplies. Use Actual Length for Order Code Entry.  
 Tolerance for Actual Lengths less than 6 ft is +/- 0.2", Actual Lengths between 6 ft and 16 ft is +/- 0.3", and Actual Lengths greater than 16 ft is +/- 0.6"  
 A - End Connector at both ends of Kurba (0.20" + 0.20" added to overall length)  
 B - End Connector at one end of Kurba and No Connector or Back Connector or Side Connector at other end of Kurba (0.20" + 0.08" added to overall length)  
 C - Any combination of No Connector, Back Connector, or Side Connector on each end of Kurba (0.08" + 0.08" added to overall length)

Nominal Length (in)	Actual Length (in)				Nominal Length (in)	Actual Length (in)				Nominal Length (in)	Actual Length (in)				Nominal Length (in)	Actual Length (in)			
	W	A	B	C		W	A	B	C		W	A	B	C		W	A	B	C
8	2.4	7.8	7.7	7.5	(8 ft) 96	29.4	96.4	96.2	96.1	185	56.4	184.9	184.8	184.7	274	83.4	273.5	273.4	273.3
10	3.1	10.2	10.1	10.0	99	30.1	98.8	98.7	98.6	187	57.1	187.4	187.3	187.2	(23 ft) 276	84.1	276.0	275.9	275.8
(1 ft) 13	3.9	12.7	12.6	12.5	101	30.9	101.3	101.2	101.0	190	57.9	189.9	189.7	189.6	278	84.9	278.5	278.3	278.2
15	4.6	15.2	15.0	14.9	104	31.6	103.7	103.6	103.5	(16 ft) 192	58.6	192.3	192.2	192.1	281	85.6	280.9	280.8	280.7
18	5.4	17.6	17.5	17.4	106	32.4	106.2	106.1	106.0	195	59.4	194.8	194.7	194.5	283	86.4	283.4	283.3	283.1
20	6.1	20.1	20.0	19.8	(9 ft) 109	33.1	108.7	108.5	108.4	197	60.1	197.3	197.1	197.0	286	87.1	285.8	285.7	285.6
23	6.9	22.5	22.4	22.3	111	33.9	111.1	111.0	110.9	200	60.9	199.7	199.6	199.5	(24 ft) 288	87.9	288.3	288.2	288.1
(2 ft) 25	7.6	25.0	24.9	24.8	114	34.6	113.6	113.5	113.3	202	61.6	202.2	202.1	201.9	291	88.6	290.8	290.6	290.5
27	8.4	27.5	27.3	27.2	116	35.4	116.0	115.9	115.8	(17 ft) 205	62.4	204.6	204.5	204.4	293	89.4	293.2	293.1	293.0
30	9.1	29.9	29.8	29.7	119	36.1	118.5	118.4	118.3	207	63.1	207.1	207.0	206.9	296	90.1	295.7	295.6	295.4
32	9.9	32.4	32.3	32.1	(10 ft) 121	36.9	121.0	120.9	120.7	210	63.9	209.6	209.4	209.3	298	90.9	298.1	298.0	297.9
(3 ft) 35	10.6	34.8	34.7	34.6	123	37.6	123.4	123.3	123.2	212	64.6	212.0	211.9	211.8	(25 ft) 301	91.6	300.6	300.5	300.4
37	11.4	37.3	37.2	37.1	126	38.4	125.9	125.8	125.7	214	65.4	214.5	214.4	214.2	303	92.4	303.1	302.9	302.8
40	12.1	39.8	39.7	39.5	128	39.1	128.4	128.2	128.1	(18 ft) 217	66.1	216.9	216.8	216.7	306	93.1	305.5	305.4	305.3
42	12.9	42.2	42.1	42.0	(11 ft) 131	39.9	130.8	130.7	130.6	219	66.9	219.4	219.3	219.2	308	93.9	308.0	307.9	307.7
45	13.6	44.7	44.6	44.5	133	40.6	133.3	133.2	133.0	222	67.6	221.9	221.7	221.6	310	94.6	310.4	310.3	310.2
(4 ft) 47	14.4	47.2	47.0	46.9	136	41.4	135.7	135.6	135.5	224	68.4	224.3	224.2	224.1	(26 ft) 313	95.4	312.9	312.8	312.7
50	15.1	49.6	49.5	49.4	138	42.1	138.2	138.1	138.0	(19 ft) 227	69.1	226.8	226.7	226.5					
52	15.9	52.1	52.0	51.8	141	42.9	140.7	140.5	140.4	229	69.9	229.2	229.1	229.0					
55	16.6	54.5	54.4	54.3	(12 ft) 143	43.6	143.1	143.0	142.9	232	70.6	231.7	231.6	231.5					
57	17.4	57.0	56.9	56.8	146	44.4	145.6	145.5	145.3	234	71.4	234.2	234.0	233.9					
(5 ft) 59	18.1	59.5	59.3	59.2	148	45.1	148.0	147.9	147.8	237	72.1	236.6	236.5	236.4					
62	18.9	61.9	61.8	61.7	150	45.9	150.5	150.4	150.3	(20 ft) 239	72.9	239.1	239.0	238.8					
64	19.6	64.4	64.3	64.1	153	46.6	153.0	152.8	152.7	242	73.6	241.5	241.4	241.3					
67	20.4	66.8	66.7	66.6	(13 ft) 155	47.4	155.4	155.3	155.2	244	74.4	244.0	243.9	243.8					
69	21.1	69.3	69.2	69.1	158	48.1	157.9	157.8	157.6	246	75.1	246.5	246.3	246.2					
(6 ft) 72	21.9	71.8	71.6	71.5	160	48.9	160.3	160.2	160.1	249	75.9	248.9	248.8	248.7					
74	22.6	74.2	74.1	74.0	163	49.6	162.8	162.7	162.6	(21 ft) 251	76.6	251.4	251.3	251.1					
77	23.4	76.7	76.6	76.4	165	50.4	165.3	165.1	165.0	254	77.4	253.8	253.7	253.6					
79	24.1	79.1	79.0	78.9	(14 ft) 168	51.1	167.7	167.6	167.5	256	78.1	256.3	256.2	256.1					
82	24.9	81.6	81.5	81.4	170	51.9	170.2	170.1	169.9	259	78.9	258.8	258.6	258.5					
(7 ft) 84	25.6	84.1	83.9	83.8	173	52.6	172.6	172.5	172.4	261	79.6	261.2	261.1	261.0					
87	26.4	86.5	86.4	86.3	175	53.4	175.1	175.0	174.9	(22 ft) 264	80.4	263.7	263.6	263.4					
89	27.1	89.0	88.9	88.7	178	54.1	177.6	177.4	177.3	266	81.1	266.1	266.0	265.9					
91	27.9	91.4	91.3	91.2	(15 ft) 180	54.9	180.0	179.9	179.8	269	81.9	268.6	268.5	268.4					
94	28.6	93.9	93.8	93.7	182	55.6	182.5	182.4	182.2	271	82.6	271.1	270.9	270.8					

Note: all values are rounded to the nearest 0.1 inch

Endcap (No Connector) -NPF

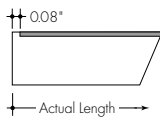

End Connector -IME

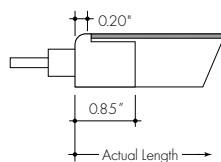

Back Connector -IMB

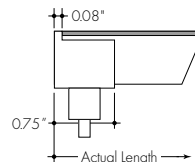

Side Connector -IMSA -IMSB

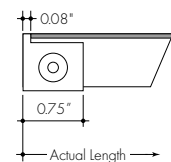

### TW44SO | Power Consumption Per Fixture Length

Based on operation with PDCU series of power supplies. Use Actual Length for Order Code Entry.  
 Tolerance for Actual Lengths less than 6 ft is +/- 0.2", Actual Lengths between 6 ft and 16 ft is +/- 0.3", and Actual Lengths greater than 16 ft is +/- 0.6"  
 A - End Connector at both ends of Kurba (0.20" + 0.20" added to overall length)  
 B - End Connector at one end of Kurba and No Connector or Back Connector or Side Connector at other end of Kurba (0.20" + 0.08" added to overall length)  
 C - Any combination of No Connector, Back Connector, or Side Connector on each end of Kurba (0.08" + 0.08" added to overall length)

Nominal Length (in)	Actual Length (in)				Nominal Length (in)	Actual Length (in)				Nominal Length (in)	Actual Length (in)			
	W	A	B	C		W	A	B	C		W	A	B	C
7	2.1	7.0	6.8	6.7	125	38.1	125.1	124.9	124.8	243	74.1	243.2	243.1	242.9
10	3.1	10.2	10.1	10.0	128	39.1	128.3	128.2	128.1	246	75.1	246.5	246.3	246.2
(1 ft) 14	4.1	13.5	13.4	13.3	(11 ft) 132	40.1	131.6	131.5	131.4	250	76.1	249.7	249.6	249.5
17	5.1	16.8	16.7	16.6	135	41.1	134.9	134.8	134.7	(21 ft) 253	77.1	253.0	252.9	252.8
20	6.1	20.1	20.0	19.8	138	42.1	138.2	138.1	137.9	256	78.1	256.3	256.2	256.1
(2 ft) 23	7.1	23.4	23.2	23.1	141	43.1	141.5	141.4	141.2	260	79.1	259.6	259.5	259.3
27	8.1	26.6	26.5	26.4	(12 ft) 145	44.1	144.8	144.6	144.5	(22 ft) 263	80.1	262.9	262.7	262.6
30	9.1	29.9	29.8	29.7	148	45.1	148.0	147.9	147.8	266	81.1	266.1	266.0	265.9
33	10.1	33.2	33.1	33.0	151	46.1	151.3	151.2	151.1	269	82.1	269.4	269.3	269.2
(3 ft) 36	11.1	36.5	36.4	36.2	(13 ft) 155	47.1	154.6	154.5	154.4	273	83.1	272.7	272.6	272.5
40	12.1	39.8	39.6	39.5	158	48.1	157.9	157.8	157.6	(23 ft) 276	84.1	276.0	275.9	275.7
43	13.1	43.0	42.9	42.8	161	49.1	161.2	161.0	160.9	279	85.1	279.3	279.1	279.0
46	14.1	46.3	46.2	46.1	164	50.1	164.4	164.3	164.2	282	86.1	282.5	282.4	282.3
(4 ft) 50	15.1	49.6	49.5	49.4	(14 ft) 168	51.1	167.7	167.6	167.5	286	87.1	285.8	285.7	285.6
53	16.1	52.9	52.8	52.7	171	52.1	171.0	170.9	170.8	(24 ft) 289	88.1	289.1	289.0	288.9
56	17.1	56.2	56.1	55.9	174	53.1	174.3	174.2	174.0	292	89.1	292.4	292.3	292.1
(5 ft) 59	18.1	59.5	59.3	59.2	178	54.1	177.6	177.4	177.3	296	90.1	295.7	295.5	295.4
63	19.1	62.7	62.6	62.5	(15 ft) 181	55.1	180.8	180.7	180.6	(25 ft) 299	91.1	298.9	298.8	298.7
66	20.1	66.0	65.9	65.8	184	56.1	184.1	184.0	183.9	302	92.1	302.2	302.1	302.0
69	21.1	69.3	69.2	69.1	187	57.1	187.4	187.3	187.2	305	93.1	305.5	305.4	305.3
(6 ft) 73	22.1	72.6	72.5	72.3	(16 ft) 191	58.1	190.7	190.6	190.4	309	94.1	308.8	308.7	308.5
76	23.1	75.9	75.7	75.6	194	59.1	194.0	193.8	193.7	(26 ft) 312	95.1	312.1	311.9	311.8
79	24.1	79.1	79.0	78.9	197	60.1	197.2	197.1	197.0					
(7 ft) 82	25.1	82.4	82.3	82.2	200	61.1	200.5	200.4	200.3					
86	26.1	85.7	85.6	85.5	(17 ft) 204	62.1	203.8	203.7	203.6					
89	27.1	89.0	88.9	88.7	207	63.1	207.1	207.0	206.8					
92	28.1	92.3	92.1	92.0	210	64.1	210.4	210.2	210.1					
(8 ft) 96	29.1	95.5	95.4	95.3	214	65.1	213.6	213.5	213.4					
99	30.1	98.8	98.7	98.6	(18 ft) 217	66.1	216.9	216.8	216.7					
102	31.1	102.1	102.0	101.9	220	67.1	220.2	220.1	220.0					
105	32.1	105.4	105.3	105.1	223	68.1	223.5	223.4	223.2					
(9 ft) 109	33.1	108.7	108.5	108.4	(19 ft) 227	69.1	226.8	226.6	226.5					
112	34.1	111.9	111.8	111.7	230	70.1	230.0	229.9	229.8					
115	35.1	115.2	115.1	115.0	233	71.1	233.3	233.2	233.1					
(10 ft) 118	36.1	118.5	118.4	118.3	237	72.1	236.6	236.5	236.4					
122	37.1	121.8	121.7	121.5	(20 ft) 240	73.1	239.9	239.8	239.7					

Note: all values are rounded to the nearest 0.1 inch

Endcap (No Connector) -NPF

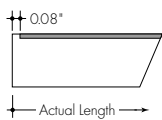

End Connector -IME

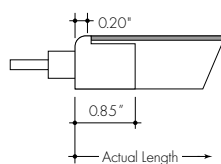

Back Connector -IMB

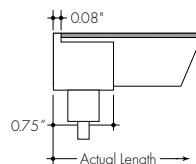

Side Connector -IMSA -IMSB

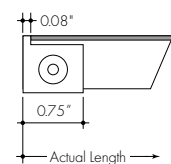

### RGB26SO | Power Consumption Per Fixture Length

Based on operation with PDCU series of power supplies. Use Actual Length for Order Code Entry. Tolerance for Actual Lengths less than 6 ft is +/- 0.2", Actual Lengths between 6 ft and 16 ft is +/- 0.3", and Actual Lengths greater than 16 ft is +/- 0.6"

- A** - End Connector at both ends of Kurba (0.20" + 0.20" added to overall length)
- B** - End Connector at one end of Kurba and No Connector or Back Connector or Side Connector at other end of Kurba (0.20" + 0.08" added to overall length)
- C** - Any combination of No Connector, Back Connector, or Side Connector on each end of Kurba (0.08" + 0.08" added to overall length)

Nominal Length (in)	Actual Length (in)				Nominal Length (in)	Actual Length (in)				Nominal Length (in)	Actual Length (in)			
	W	A	B	C		W	A	B	C		W	A	B	C
7	2.1	7.0	6.8	6.7	125	38.1	125.1	124.9	124.8	243	74.1	243.2	243.1	242.9
10	3.1	10.2	10.1	10.0	128	39.1	128.3	128.2	128.1	246	75.1	246.5	246.3	246.2
(1 ft) 14	4.1	13.5	13.4	13.3	(11 ft) 132	40.1	131.6	131.5	131.4	250	76.1	249.7	249.6	249.5
17	5.1	16.8	16.7	16.6	135	41.1	134.9	134.8	134.7	(21 ft) 253	77.1	253.0	252.9	252.8
20	6.1	20.1	20.0	19.8	138	42.1	138.2	138.1	137.9	256	78.1	256.3	256.2	256.1
(2 ft) 23	7.1	23.4	23.2	23.1	141	43.1	141.5	141.4	141.2	260	79.1	259.6	259.5	259.3
27	8.1	26.6	26.5	26.4	(12 ft) 145	44.1	144.8	144.6	144.5	(22 ft) 263	80.1	262.9	262.7	262.6
30	9.1	29.9	29.8	29.7	148	45.1	148.0	147.9	147.8	266	81.1	266.1	266.0	265.9
33	10.1	33.2	33.1	33.0	151	46.1	151.3	151.2	151.1	269	82.1	269.4	269.3	269.2
(3 ft) 36	11.1	36.5	36.4	36.2	(13 ft) 155	47.1	154.6	154.5	154.4	273	83.1	272.7	272.6	272.5
40	12.1	39.8	39.6	39.5	158	48.1	157.9	157.8	157.6	(23 ft) 276	84.1	276.0	275.9	275.7
43	13.1	43.0	42.9	42.8	161	49.1	161.2	161.0	160.9	279	85.1	279.3	279.1	279.0
46	14.1	46.3	46.2	46.1	164	50.1	164.4	164.3	164.2	282	86.1	282.5	282.4	282.3
(4 ft) 50	15.1	49.6	49.5	49.4	(14 ft) 168	51.1	167.7	167.6	167.5	286	87.1	285.8	285.7	285.6
53	16.1	52.9	52.8	52.7	171	52.1	171.0	170.9	170.8	(24 ft) 289	88.1	289.1	289.0	288.9
56	17.1	56.2	56.1	55.9	174	53.1	174.3	174.2	174.0	292	89.1	292.4	292.3	292.1
(5 ft) 59	18.1	59.5	59.3	59.2	178	54.1	177.6	177.4	177.3	296	90.1	295.7	295.5	295.4
63	19.1	62.7	62.6	62.5	(15 ft) 181	55.1	180.8	180.7	180.6	(25 ft) 299	91.1	298.9	298.8	298.7
66	20.1	66.0	65.9	65.8	184	56.1	184.1	184.0	183.9	302	92.1	302.2	302.1	302.0
69	21.1	69.3	69.2	69.1	187	57.1	187.4	187.3	187.2	305	93.1	305.5	305.4	305.3
(6 ft) 73	22.1	72.6	72.5	72.3	(16 ft) 191	58.1	190.7	190.6	190.4	309	94.1	308.8	308.7	308.5
76	23.1	75.9	75.7	75.6	194	59.1	194.0	193.8	193.7	(26 ft) 312	95.1	312.1	311.9	311.8
79	24.1	79.1	79.0	78.9	197	60.1	197.2	197.1	197.0					
(7 ft) 82	25.1	82.4	82.3	82.2	200	61.1	200.5	200.4	200.3					
86	26.1	85.7	85.6	85.5	(17 ft) 204	62.1	203.8	203.7	203.6					
89	27.1	89.0	88.9	88.7	207	63.1	207.1	207.0	206.8					
92	28.1	92.3	92.1	92.0	210	64.1	210.4	210.2	210.1					
(8 ft) 96	29.1	95.5	95.4	95.3	214	65.1	213.6	213.5	213.4					
99	30.1	98.8	98.7	98.6	(18 ft) 217	66.1	216.9	216.8	216.7					
102	31.1	102.1	102.0	101.9	220	67.1	220.2	220.1	220.0					
105	32.1	105.4	105.3	105.1	223	68.1	223.5	223.4	223.2					
(9 ft) 109	33.1	108.7	108.5	108.4	(19 ft) 227	69.1	226.8	226.6	226.5					
112	34.1	111.9	111.8	111.7	230	70.1	230.0	229.9	229.8					
115	35.1	115.2	115.1	115.0	233	71.1	233.3	233.2	233.1					
(10 ft) 118	36.1	118.5	118.4	118.3	237	72.1	236.6	236.5	236.4					
122	37.1	121.8	121.7	121.5	(20 ft) 240	73.1	239.9	239.8	239.7					

Note: all values are rounded to the nearest 0.1 inch

Endcap (No Connector) -NPF

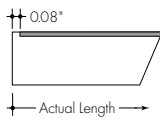

End Connector -IME

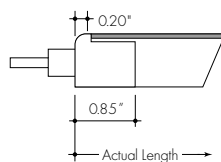

Back Connector -IMB

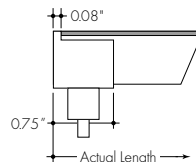

Side Connector -IMSA -IMSB

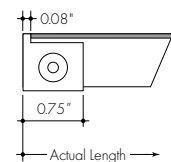



### RGBW26SO | Power Consumption Per Fixture Length

Based on operation with PDCU series of power supplies. Use Actual Length for Order Code Entry.  
 Tolerance for Actual Lengths less than 6 ft is +/- 0.2", Actual Lengths between 6 ft and 16 ft is +/- 0.3", and Actual Lengths greater than 16 ft is +/- 0.6"  
 A - End Connector at both ends of Kurba (0.20" + 0.20" added to overall length)  
 B - End Connector at one end of Kurba and No Connector or Back Connector or Side Connector at other end of Kurba (0.20" + 0.08" added to overall length)  
 C - Any combination of No Connector, Back Connector, or Side Connector on each end of Kurba (0.08" + 0.08" added to overall length)

Nominal Length (in)	Actual Length (in)				Nominal Length (in)	Actual Length (in)			
	W	A	B	C		W	A	B	C
7	2.7	7.0	6.8	6.7	125	47.6	125.1	124.9	124.8
10	3.9	10.2	10.1	10.0	128	48.9	128.3	128.2	128.1
(1 ft) 14	5.1	13.5	13.4	13.3	(11 ft) 132	50.1	131.6	131.5	131.4
17	6.4	16.8	16.7	16.6	135	51.4	134.9	134.8	134.7
20	7.6	20.1	20.0	19.8	138	52.6	138.2	138.1	137.9
(2 ft) 23	8.9	23.4	23.2	23.1	141	53.9	141.5	141.4	141.2
27	10.1	26.6	26.5	26.4	(12 ft) 145	55.1	144.8	144.6	144.5
30	11.4	29.9	29.8	29.7	148	56.4	148.0	147.9	147.8
33	12.6	33.2	33.1	33.0	151	57.6	151.3	151.2	151.1
(3 ft) 36	13.9	36.5	36.4	36.2	(13 ft) 155	58.9	154.6	154.5	154.4
40	15.1	39.8	39.6	39.5	158	60.1	157.9	157.8	157.6
43	16.4	43.0	42.9	42.8	161	61.4	161.2	161.0	160.9
46	17.6	46.3	46.2	46.1	164	62.6	164.4	164.3	164.2
(4 ft) 50	18.9	49.6	49.5	49.4	(14 ft) 168	63.9	167.7	167.6	167.5
53	20.1	52.9	52.8	52.7	171	65.1	171.0	170.9	170.8
56	21.4	56.2	56.1	55.9	174	66.4	174.3	174.2	174.0
(5 ft) 59	22.6	59.5	59.3	59.2	178	67.6	177.6	177.4	177.3
63	23.9	62.7	62.6	62.5	(15 ft) 181	68.9	180.8	180.7	180.6
66	25.1	66.0	65.9	65.8	184	70.1	184.1	184.0	183.9
69	26.4	69.3	69.2	69.1	187	71.4	187.4	187.3	187.2
(6 ft) 73	27.6	72.6	72.5	72.3	(16 ft) 191	72.6	190.7	190.6	190.4
76	28.9	75.9	75.7	75.6	194	73.9	194.0	193.8	193.7
79	30.1	79.1	79.0	78.9	197	75.1	197.2	197.1	197.0
(7 ft) 82	31.4	82.4	82.3	82.2	200	76.4	200.5	200.4	200.3
86	32.6	85.7	85.6	85.5	(17 ft) 204	77.6	203.8	203.7	203.6
89	33.9	89.0	88.9	88.7	207	78.9	207.1	207.0	206.8
92	35.1	92.3	92.1	92.0	210	80.1	210.4	210.2	210.1
(8 ft) 96	36.4	95.5	95.4	95.3	214	81.4	213.6	213.5	213.4
99	37.6	98.8	98.7	98.6	(18 ft) 217	82.6	216.9	216.8	216.7
102	38.9	102.1	102.0	101.9	220	83.9	220.2	220.1	220.0
105	40.1	105.4	105.3	105.1	223	85.1	223.5	223.4	223.2
(9 ft) 109	41.4	108.7	108.5	108.4	(19 ft) 227	86.4	226.8	226.6	226.5
112	42.6	111.9	111.8	111.7					
115	43.9	115.2	115.1	115.0					
(10 ft) 118	45.1	118.5	118.4	118.3					
122	46.4	121.8	121.7	121.5					

Note: all values are rounded to the nearest 0.1 inch

Endcap (No Connector) -NPF

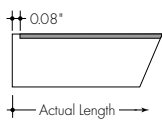

End Connector -IME

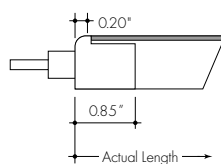

Back Connector -IMB

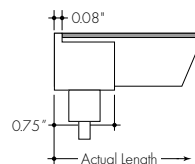

Side Connector -IMSA -IMSB

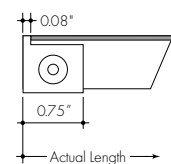

### SPI26SO | Power Consumption Per Fixture Length

Based on operation with PDCU series of power supplies. Use Actual Length for Order Code Entry.  
 Tolerance for Actual Lengths less than 6 ft is +/- 0.2", Actual Lengths between 6 ft and 16 ft is +/- 0.3", and Actual Lengths greater than 16 ft is +/- 0.6"  
 A - End Connector at both ends of Kurba (0.20" + 0.20" added to overall length)  
 B - End Connector at one end of Kurba and No Connector or Back Connector or Side Connector at other end of Kurba (0.20" + 0.08" added to overall length)  
 C - Any combination of No Connector, Back Connector, or Side Connector on each end of Kurba (0.08" + 0.08" added to overall length)

Nominal Length (in)	Actual Length (in)					Nominal Length (in)	Actual Length (in)				
	W	A	B	C	Pixel Qty		W	A	B	C	Pixel Qty
7	3.9	7.0	6.8	6.7	2	125	62.9	125.1	124.9	124.8	38
10	5.7	10.2	10.1	10.0	3	128	64.6	128.3	128.2	128.1	39
(1 ft) 14	7.6	13.5	13.4	13.3	4	(11 ft) 132	66.2	131.6	131.5	131.4	40
17	9.4	16.8	16.7	16.6	5	135	67.9	134.9	134.8	134.7	41
20	11.2	20.1	20.0	19.8	6	138	69.5	138.2	138.1	137.9	42
(2 ft) 23	13.1	23.4	23.2	23.1	7	141	71.2	141.5	141.4	141.2	43
27	14.9	26.6	26.5	26.4	8	(12 ft) 145	72.8	144.8	144.6	144.5	44
30	16.7	29.9	29.8	29.7	9	148	74.5	148.0	147.9	147.8	45
33	18.6	33.2	33.1	33.0	10	151	76.1	151.3	151.2	151.1	46
(3 ft) 36	20.4	36.5	36.4	36.2	11	(13 ft) 155	77.8	154.6	154.5	154.4	47
40	22.2	39.8	39.6	39.5	12	158	79.4	157.9	157.8	157.6	48
43	24.1	43.0	42.9	42.8	13	161	81.1	161.2	161.0	160.9	49
46	25.9	46.3	46.2	46.1	14	164	82.7	164.4	164.3	164.2	50
(4 ft) 50	27.7	49.6	49.5	49.4	15	(14 ft) 168	84.4	167.7	167.6	167.5	51
53	26.6	52.9	52.8	52.7	16	171	86.0	171.0	170.9	170.8	52
56	28.3	56.2	56.1	55.9	17	174	87.7	174.3	174.2	174.0	53
(5 ft) 59	29.9	59.5	59.3	59.2	18	178	89.3	177.6	177.4	177.3	54
63	31.6	62.7	62.6	62.5	19	(15 ft) 181	91.0	180.8	180.7	180.6	56
66	33.2	66.0	65.9	65.8	20	184	92.6	184.1	184.0	183.9	57
69	34.9	69.3	69.2	69.1	21	187	94.3	187.4	187.3	187.2	58
(6 ft) 73	36.5	72.6	72.5	72.3	22	(16 ft) 191	95.9	190.7	190.6	190.4	59
76	38.2	75.9	75.7	75.6	23						
79	39.8	79.1	79.0	78.9	24						
(7 ft) 82	41.5	82.4	82.3	82.2	25						
86	43.1	85.7	85.6	85.5	26						
89	44.8	89.0	88.9	88.7	27						
92	46.4	92.3	92.1	92.0	28						
(8 ft) 96	48.1	95.5	95.4	95.3	29						
99	49.7	98.8	98.7	98.6	30						
102	51.4	102.1	102.0	101.9	31						
105	53.0	105.4	105.3	105.1	32						
(9 ft) 109	54.7	108.7	108.5	108.4	33						
112	56.3	111.9	111.8	111.7	34						
115	58.0	115.2	115.1	115.0	35						
(10 ft) 118	59.6	118.5	118.4	118.3	36						
122	61.3	121.8	121.7	121.5	37						

Note: all values are rounded to the nearest 0.1 inch

Endcap (No Connector) -NPF

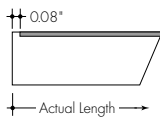

End Connector -IME

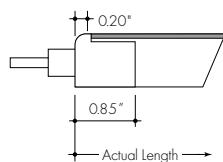

Back Connector -IMB

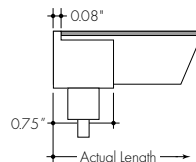

Side Connector -IMSA -IMSB

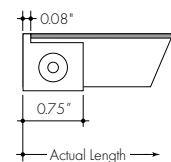

## Power Supplies

See fixture and power supply instructions & spec sheet for wiring information. Dimming possible in select models - view Luminii website for list of compatible dimmers.

### For use with Warm Dim

#### Phase Dimming Power Supply 1% 120VAC - 277VAC

MODEL	INPUT CONTROL	ENVIRONMENT	WATTAGE	OUTPUT	OUTPUT CONTROL
PS-Power Supply, 120-277VAC	PH-Phase Dimming (Triac, ELV, MLV)	D-Dry	96-96 Watts	24-24 VDC	DC-Direct Current

MLV/ELV/TRIAC - 1% dimming, consult dimming compatibility chart [\(Link\)](#)

MODELS	96W
Length	8.25"
Width	4.10"
Depth	1.56"

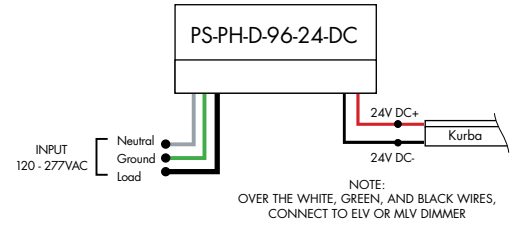

### For use with Tunable White

#### DALI2 Dimming Power Supplies 0.1% 120VAC - 277VAC

MODEL	INPUT CONTROL	ENVIRONMENT	WATTAGE	OUTPUT	OUTPUT CONTROL
PS-Power Supply, 120-277VAC	DALI-DT8-DALI DT8 Tunable White (0.1%)	D-Dry	96-96 Watts	24-24 VDC	PWM-Pulse Width Modulation

MODELS	96W
Length	14.40"
Width	5.20"
Depth	2.60"

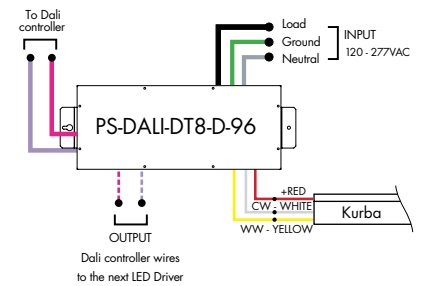

#### Athena DALI2-DT8 LED Driver

MODEL	INPUT CONTROL	ENVIRONMENT	WATTAGE	OUTPUT	FEATURE
PS-Power Supply, 120-277VAC	DALI-DT8-DALI DT8 Tunable White	D-Dry	96-96 Watts	24-24 VDC	AWNDR-Athena

MODELS	96W
Length	14.40"
Width	5.20"
Depth	2.60"

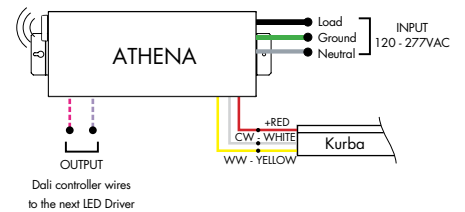

## Power Supplies

See fixture and power supply instructions & spec sheet for wiring information. Dimming possible in select models - view Luminii website for list of compatible dimmers.

### For use with Tunable White

#### VintageDim® 0 - 10V Dimming Power Supplies 0.1% 120VAC - 277VAC

MODEL	INPUT CONTROL	ENVIRONMENT	WATTAGE	OUTPUT
PS - Power Supply, 120-277VAC	010V-WD - 0-10V Dimming (0.1%), Standard Warm Dim Curve (with Tunable White LED) 010V-TW - 0-10V Dimming (0.1%), Two Channel Control, Brightness and CCT1-CCT2 Ratio 010V-2CH - 0-10V Dimming (0.1%), Two Channel Control, LED1 Brightness and LED2 Brightness 010V-WDX - 0-10V Dimming (0.1%), Customizable Warm Dim Curve (with Tunable White LED) 010V-2CHX - 0-10V Dimming (0.1%), Two Channel Control, Customizable Brightness and CCT1-CCT2 Ratio	D-Dry	96-96 Watts 3X96-3x96 Watts <sup>1</sup>	24-24 VDC

1 - 3x96 is only available with input control options 010V-WD and 010V-TW  
2 - Athena only available on 96 watts option

MODELS	96W	3X96
Length	14.40"	15.00"
Width	5.20"	6.62"
Depth	2.60"	4.56"

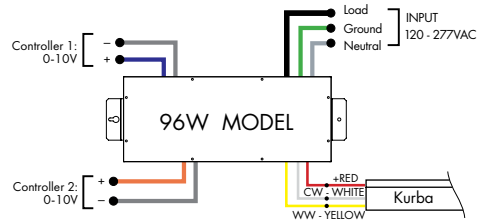
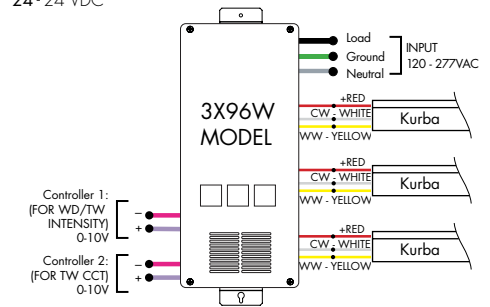

#### Athena 0-10V Warm Dim LED Driver

MODEL	INPUT CONTROL	ENVIRONMENT	WATTAGE	OUTPUT	FEATURE
PS - Power Supply, 120-277VAC	010V-WD - 0-10V Dimming, Standard Warm Dim Curve (with Dynamic White LED)	D-Dry	96-96 W	24-24 VDC	AWN-R-Athena

MODELS	96W
Length	14.40"
Width	5.20"
Depth	2.60"

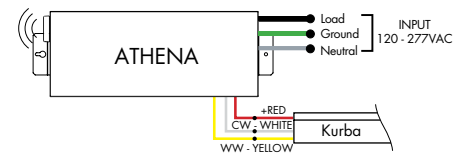

#### Athena 0-10V Two Channel LED Driver

MODEL	INPUT CONTROL	ENVIRONMENT	WATTAGE	OUTPUT	FEATURE
PS - Power Supply, 120-277VAC	010V-2CH - 0-10V Dimming Two Channel Control, LED1 Brightness and LED2 Brightness	D-Dry	96-96 W	24-24 VDC	AWN-R-Athena

MODELS	96W
Length	14.40"
Width	5.20"
Depth	2.60"

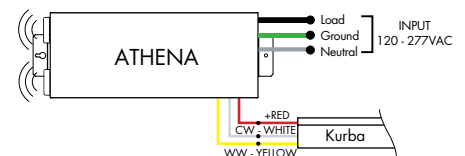

## Power Supplies

See fixture and power supply instructions & spec sheet for wiring information. Dimming possible in select models - view Luminii website for list of compatible dimmers.

### For use with RGB/RGBW, Tunable White

Requires Controller

#### DMX Dimming Power Supplies 0.1% 120VAC - 277VAC

MODEL	INPUT CONTROL	ENVIRONMENT	WATTAGE	OUTPUT
PS - Power Supply, 120-277VAC	DMX - DMX (0.1%)	D - Dry	96 - 96 Watts 3X96 - 3X96 Watts	24 - 24 VDC

MODELS	96W	3X96
<b>Length</b>	14.40"	15.00"
<b>Width</b>	5.20"	6.62"
<b>Depth</b>	2.60"	4.56"

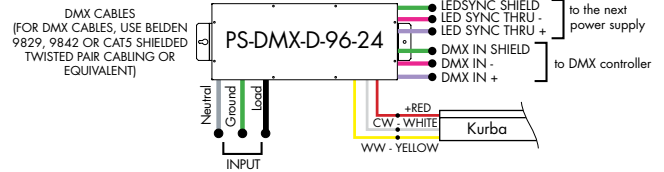
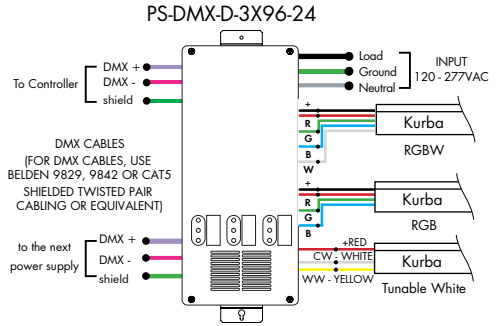

### For use with RGB/RGBW/Pixel

#### Non-Dimming Power Supply 120VAC - 277VAC

MODEL	INPUT CONTROL	ENVIRONMENT	WATTAGE	OUTPUT
PS - PSV Series	ND - Non Dimming	D - Dry	96 - 96 Watts	24 - 24 VDC

Requires a controller and a decoder to work properly

MODELS	96W
<b>Length</b>	14.40"
<b>Width</b>	5.20"
<b>Depth</b>	2.60"

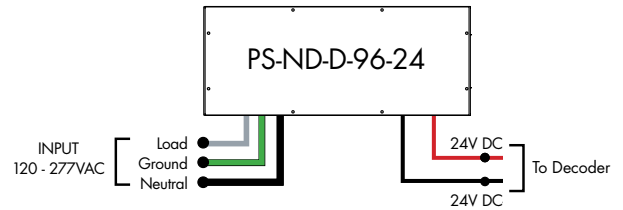

### For use with RGB/RGBW

#### Universal Dimming Power Supplies 1% 120VAC - 277VAC

MODEL	INPUT CONTROL	ENVIRONMENT	WATTAGE	OUTPUT
PS - Power Supply, 120-277VAC	UNI-0-10V Dimming, Phase Dimming	D - Dry W - Wet	30 - 30 Watts 60 - 60 Watts 96 - 96 Watts 3x96 - 3x96 Watts	24 - 24 VDC

Compatibility: View a complete list of compatible dimmers on product page [Link](#) 0-10V - 1% dimming MLV/ELV/TRIAC - 1% dimming, consult dimming compatibility chart

MODELS	PS-UNI-W-30W	PS-UNI-W-60W	PS-UNI-W-96W	PS-UNI-W-3X96W
<b>Length</b>	6.50"	7.40"	8.66"	11.85"
<b>Width</b>	3.73"	3.73"	3.73"	4.32"
<b>Depth</b>	1.61"	1.61"	1.61"	1.81"

MODELS	PS-UNI-D-30W	PS-UNI-D-60W	PS-UNI-D-96W	PS-UNI-D-3X96W
<b>Length</b>	8.77"	8.77"	8.11"	9.94"
<b>Width</b>	4.27"	4.27"	5.60"	7.61"
<b>Depth</b>	1.83"	1.83"	1.83"	2.02"

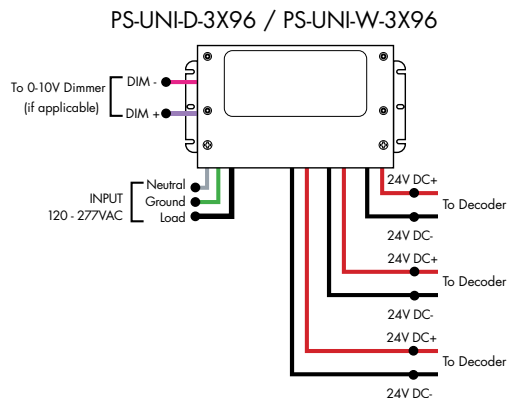
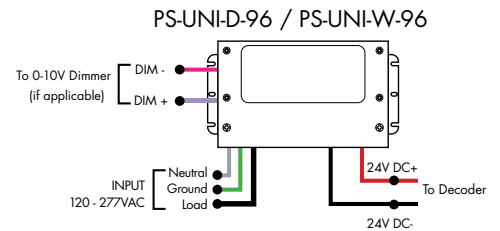

## Controllers and Decoders

### For use with Tunable White Power Supplies



ORDERING CODE

MODEL

**DTW-MC**

DTW-MC - Tunable White controller

Tunable White wall-mount controller controls lighting fixtures, wireless control of TW lighting fixture. Fits in any standard US switch box. Includes all the outputs in the back of the controller.

#### Features

- Switch & dimming control function, control range > 20M.
- Smooth transition between light levels.
- Separately operate dimming and color temperature functions.
- Able to control 1 zone with endless receivers. Each receiver can maximally be controlled by 8 remotes.
- Power, temperature color and dimming functions operated by push button after receivers are connected.

#### Operating Voltage

3V DC battery

#### Color Parameters

- Brightness
- Saturation
- Fading



ORDERING CODE

MODEL

**TW-DMX**

TW-DMX - DMX controller

Tunable White DMX wall-mount controller is a fully touch sensitive controller designed in accordance with standard protocol DMX512. Offers fast and accurate color temperature adjustment and brightness dimming of natural white, warm white and cold white. Designed with a touch color wheel, the DMX512 controller can adjust color temperature and brightness for all white LEDs smoothly and accurately. The DMX controller can control 1 zone with endless decoders.

#### Features

- 1 zone
- 6 color scenes
- DMX Control
- Touch Sensitive Glass Surface
- Dimming and Speed Control
- Memory Function
- Easily Fits Standard US Switch Boxes

#### Operating Voltage

12 - 24V DC

#### Color Parameters

- Brightness
- Saturation
- Primary colors
- Fading
- Color changing speed



ORDERING CODE

MODEL

**SLD-DIMTW**

SLD-DIMTW - Tunable white LED dimming module

The SLD DimTW is a constant voltage warm dimming LED dimming module. The unique dimming module accepts 0-10V control and mimics a smooth, incandescent dimming curve.

#### Features

- Flicker free 0-100% dimming
- High efficiency up to 97%
- High precision dimming ratio:>1:1000
- Fully isolated plastic housing
- Comply with EN55015 and FCC part 15 without additional input filter and capacitors
- compact size, high reliability
- 3 years warranty

#### Operating Voltage

8-48 VDC

## Controllers and Decoders

### For use with Tunable White, RGB/RGBW Power Supplies



Translates controller DMX512 programs for RGB and white LED strips.

Unique DMX address for the decoder can be set easily and displayed by the numeric display on the case. Changing and resetting the DMX address requires manual input.

Use power repeater to expand output.

**Operating Voltage**

12-36 VDC

**Power Capacity**

up to 96W at 24V

**Operating Temperature Range**

from -4°F to +122°F in case

ORDERING CODE

MODEL

**DDMX-RGBW**

DDMX-RGBW - DMX decoder



The RGBW receiver is easily paired with controller by the click of a button. Receiver can be reset to factory settings at any time.

Each receiver can store one static RGB color, one color sequence, and one brightness setting for the white LED strip. Receivers assigned to the same scene within the same zone will have the same LED static color and color sequence.

**Operating Voltage**

12-36 VDC

**Power Capacity**

up to 96W at 24V

**Operating Temperature Range**

from -4°F to +122°F in case

ORDERING CODE

MODEL

**RGBW-RC-R**

RGBW-RC-R - RGBW receiver



Extends identical signal when connected in series to an RGBW LED control system. The RGBW signal repeater works with Luminii RGB and RGBW controllers, receivers, and decoders.

RGBW signal can be extended indefinitely when adequate power supply (not included) is connected to the system.

**Operating Voltage**

12-36 VDC

**Power Capacity**

up to 96W at 24V

**Operating Temperature Range**

from -4°F to +122°F in case

ORDERING CODE

MODEL

**RGBW-SR**

RGBW-SR - RGBW signal repeater

## Controllers and Decoders

### For use with RGB/RGBW Power Supplies



ORDERING CODE

MODEL

**RGBW-MC3**

RGBW-MC3 - 4-zone RGBW controller

Easy to operate wireless interface suitable for static or color changing scenes. Control 4 different color zones separately or at the same time. RGBW receiver (RGBWV-RC-R) required for operation. Assign multiple receivers per zone to cover a large area.

Color wheel enables highly stable and sensitive color control functionality. Create your own color changing sequences with ease and flexibility.

**Power**

qty 3 AAA batteries

**Scenes**

up to 4 unique zones

**Signal**

Wireless (RF)

**Energy Saving**

Deactivates after 10 seconds of inactivity

**Color Parameters**

- Brightness
- Saturation
- Primary colors
- Speed of color changing sequence
- Fading

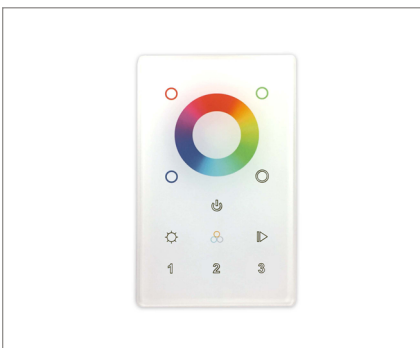

ORDERING CODE

MODEL

ZONES

COLOR

--	--	--

DMX - DMX Controller    3Z - Three Zone    RGBW - Red, Green, Blue, & White  
 1Z - One Zone

DMX /Wireless RGB-W wall-mount controller controls DMX lighting fixtures, wireless control of RGB-W lighting fixture or use both simultaneously. Fits in any standard US switch box. Includes all the outputs in the back of the controller.

Control brightness levels with a single touch, personalize and memorize 3 different scenes, and even create 3 variations of white.

**Features**

- 2 in 1 in-Wall Controller: DMX Control or Wireless RGB-W
- 65,000 Color Options, Dimming and Speed Control
- Memory Function
- 50 Foot Wireless Range
- Easily Fits Standard US Switch Boxes
- Touch Sensitive Glass Surface
- Includes 10 Built in Programs, or Create and Play Your Own

**Operating Voltage**

12 - 24V DC

**Color Parameters**

- Brightness
- Saturation
- Primary colors
- Fading
- Color changing speed

### For use with Tunable White, RGB/RGBW, Pixel Power Supplies

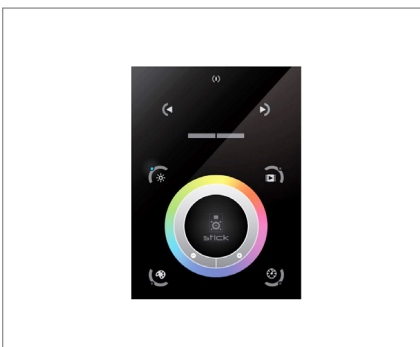

ORDERING CODE

MODEL

**TSDMX-E**

TSDMX-E - Touchscreen DMX controller

Programmable advanced DMX512 lighting controller featuring a touch-screen interface. Operates as stand alone controller or integrated with most architectural lighting control systems. Can controller endless DMX512 enabled devices.

Mounts to standard single or dual gang wall box with the included power supply inside the junction box. Terminal block design for power and data connections.

**Features**

- Sleek glass design which sits 0.43" from the wall
- Graphical color display to show selected environment
- Color/dimmer/speed palette
- Color temperature mixing
- Touch sensitive buttons. No mechanical parts
- Touch sensitive wheel allows for accurate color selection
- Multi-zone microSD memory
- Multi-room control with 500 scenes, 10 zones
- 1024 DMX channels. Control 340 RGB fixtures
- USB & Ethernet connectivity for programming and control

**Power Supply**

7 VDC (included)

**Programmability**

PC, Mac, Tablet, Smartphone

**Output Signal**

DMX512 (1024 channels)

**Color Parameters**

- Brightness
- Saturation
- Speed of color changing sequence
- Fading / dimming / brightness



## Controllers and Decoders

### For use with Pixel Power Supplies



ORDERING CODE

MODEL

**SR-DMX-SPI**

SR-DMX-SPI - Smart Pixel Decoder

The SR-DMX-SPI is a smart LED pixel decoder that controls RGB/RGBW pixel LED strips with SPI signal. Designed with an OLED backlit panel, the pixel controller allows for easy configuration of most settings. Four push buttons are available for control of the LED functions.

\*For pixel only.

#### Features

- 2 in 1 in-Wall Controller: DMX Control or Wireless RGB-W
- SPI signal output for RGB/RGBW pixel light control
- DMX512 controllable and RF/WIFI remote controllable
- Capable of addressing up to 1020 RGB pixels & 765 RGBW pixels
- OLED panel allows for easy configuration

#### Operating Voltage

12 - 36V DC

#### Power capacity

up to 96W at 24V

#### Operating temperature range

from -4°F to +122°F in case

### For use with Tunable White, RGB/RGBW Power Supplies



ORDERING CODE

MODEL

**DDMX-5CH-RDM-PRO**

DDMX-5CH-RDM-PRO - DMX512 Decoder

DMX512 decoder with RDM functionality features 5 PWM output channels with common anode. High PWM output frequency range allows the product to be used in HD video conferencing spaces. All DMX products to be installed per DMX512 Standard.

#### Power

96 Watt

#### Inputs

RJ45, XLR-5Pin, Terminal Block

#### DMX Channels

1 to 5 settable

#### PWM Output Resolution Ratio

8 or 16 bit

#### PWM Output Frequency

500Hz - 30KHz

#### Output Dimming Curve Gamma Value

0.1 ~ 9.9



ORDERING CODE

MODEL

**RGBW-WI-R**

RGBW-WI-R - WIFI generator

RGBW-WI-R creates a local network that enables any electronic device (phone, tablet, etc.) to control the RGB/W strip connected to a RGBW-RC-R receiver.

The control functions are achieved through a free application download for Android and iOS devices called REALCOLOR.

#### Operating Voltage

12-36 VDC

#### Power Supply

PI-130-24 (included)

#### Operating Temperature Range

from -4°F to +122°F in case