

**Features**

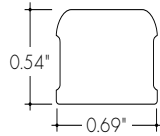

- 24VDC Class 2 and IP68 rated for wet locations, fixtures made to order up to 144". Fixtures can be linked up to 32' depending on output
- Suitable for surface mount, grazer, outdoor, wet, architectural reveals, handrail, and accent lighting
- Proprietary strong bond solder method handles up to 50 lbs of pull force on wire leads and connectors.
- Average Life (L70): 50,000hrs
- 3 year warranty
- WD68 Warm Dim follows the incandescent dimming curve and is compatible with MLV, ELV, and Incandescent dimmers.
- Tunable White allows individual control of CCT and output, can be paired with Vintage Dim power supply for warm dim effect
- RGB offers balanced output across the color gamut and a true white with RGBW
- Smart Pixel allows for infinite color combinations with cascading and chasing effects

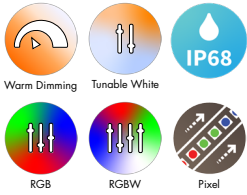

**Finish Options** (see page 3 for additional information)

- Base  Silver Anodized
- Powder Coat  Black  Bronze  White
- Premium  Matte Black  Warm Nickel  Aged Brass  Polished Gold  Chrome



**Technical Information**

TYPE	Warm Dim	Tunable White		RGBW		RGB		Pixel	
OUTPUT OPTIONS	WD68SO (22K-32K)	TW68HO (22K-46K)	TW68VHO (22K-46K)	RGBW36SO	RGBW36HO	RGB42SO	RGB42HO	RGBWX18SO	RGBX18SO
Lumens Output (all channels full on)	182 lm/ft	173 lm/ft	204 lm/ft	110 lm/ft	184 lm/ft	110 lm/ft	162 lm/ft	134 lm/ft	88 lm/ft
Average Power Consumption (for a 4' section)	5.4 W/ft	4.6 W/ft	5.6 W/ft	4 W/ft	7.6 W/ft	4.5 W/ft	8.3 W/ft	5.7 W/ft	4.5 W/ft
Efficacy	34 lm/W	38 lm/W	37 lm/W	28 lm/W	24 lm/W	24 lm/W	20 lm/W	24 lm/W	20 lm/W
Max Run Length (in series)	20 ft	32 ft	32 ft	26 ft	13 ft	28 ft	13 ft	20 ft	30 ft
Ambient Operating Temperature Range*	-15°F - 125°F (-25°C - 50°C)	-15°F - 125°F (-25°C - 50°C)		-15°F - 125°F (-25°C - 50°C)	-15°F - 105°F (-25°C - 40°C)	-15°F - 125°F (-25°C - 50°C)	-15°F - 95°F (-25°C - 35°C)	-15°F - 125°F (-25°C - 50°C)	
Control/Dimming Protocol	MLV, ELV, Inc.	0-10V, DMX				DMX		SPI Protocol UCS 2904	SPI Protocol UCS 2903

\* Ambient Operating Temperature Range to maintain L70 of 50k+ hours in normal mounting conditions for the fixture. Exceeding Ambient Operating Temperature Range may result in decreased life/output. Consult Technical Support for specific inquiries.

Warm Dim (WD68)					Tunable White (TW68)					RGBW (4000K)					Dominant Wavelength		
CCT	CRI	R <sub>f</sub>	R <sub>g</sub>	R <sub>b</sub>	CCT	CRI	R <sub>f</sub>	R <sub>g</sub>	R <sub>b</sub>	Tape	CRI	R <sub>f</sub>	R <sub>g</sub>	R <sub>b</sub>	Color	RGB42/RGBW36	RGBX18/RGBWX18
2200K	96	92	96	94	2200K	97	94	98	95	RGBW36	95	93	106	84	Red	620nm	621nm
3200K	96	93	106	95	3500K	98	96	102	94	RGBWX18	93	91	99	64	Green	525nm	519nm
					4600K	97	94	105	97						Blue	467nm	465nm

**Ordering Code**

MODEL	LENGTH <sup>1</sup>	OUTPUT	CCT	LENS	MOUNTING	FINISH <sup>2</sup>	FEED POSITION LEFT <sup>4</sup>	FEED POSITION RIGHT <sup>4</sup>	ACCESSORIES			
KMW - Kendo M Wet	12"-144" 3" increments	WD68SO - Standard	22K32K-2200K-3200K	GR - Narrow Grazer Beam	FC - Fixed Clip A - Adjustable Hinge Mounting FC45 - Fixed Clip, EFC - 45° Tamper Resistant Fixed	BASE SA - Silver Anodized	WIRE LEADS (72") LWE - Wire End Feed LWB - Wire Back Feed LWSA - Wire Side A Feed LWSB - Wire Side B Feed LNPF - No Power Feed	WIRE LEADS (72") RWE - Wire End Feed RWB - Wire Back Feed RWSA - Wire Side A Feed RWSB - Wire Side B Feed RNPF - No Power Feed	--- N/A, leave blank BLS - Blade lower, Silver BLBK - Blade lower, Black BLWH - Blade lower, White GSS - Glare shield, Silver GSBK - Glare shield, Black GSWH - Glare shield, White			
	12"-144" 3" increments	TW68HO - Standard TW68HO - High	22K46K-2200K-4600K							STANDARD BK - Black BZ - Bronze WH - White	QUICK CONNECTS (4") LFE - Female Q/C, End Feed LFB - Female Q/C, Back Feed LFSA - Female Q/C, Side A Feed LFSB - Female Q/C, Side B Feed LNPF - No Power Feed	QUICK CONNECTS (4") RFE - Female Q/C, End Feed RFB - Female Q/C, Back Feed RFSA - Female Q/C, Side A Feed RFSB - Female Q/C, Side B Feed RNPF - No Power Feed
	12"-144" 2" increments	RGBW36SO - Standard RGBW36HO - High RGB42SO - Standard RGB42HO - High	CLR - Color									
	12"-144" 4" increments	RGBWX18SO - Pixel Standard RGBX18SO - Pixel Standard	PXSPI - Smart Pixel Control									

1 - Custom lengths and increments are available, please consult Inside Sales with specific request.

2 - Non Base finishes may have extended lead times. Custom RALs are available, please consult Inside Sales with specific request.

3 - Polished Gold finishes and Chrome finishes have a maximum fixture length of 96".

4 - LNPF - RNPF is not a valid configuration option

**Powerfeeds and Connectors**

**Power Feed Position Options and Orientation**

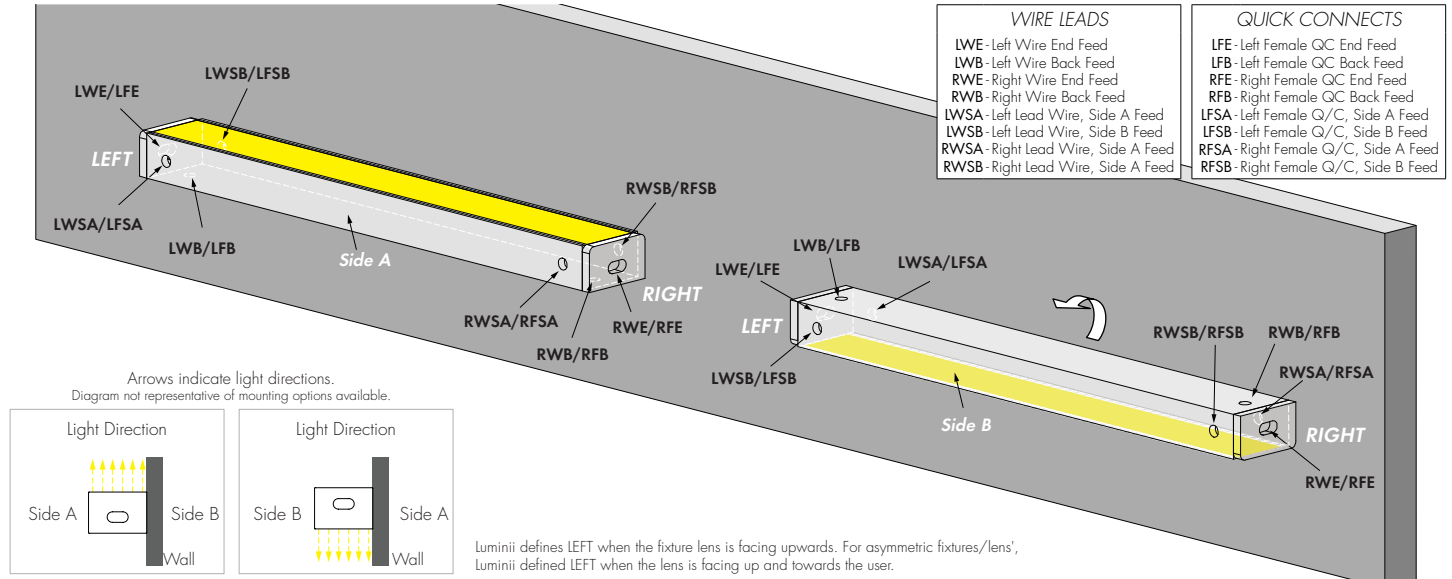

**Linking and Extension Cable Options**

**For use with Warm Dim (WD68):**

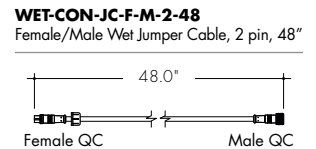
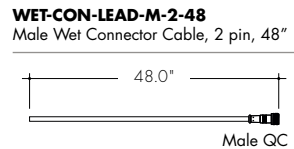
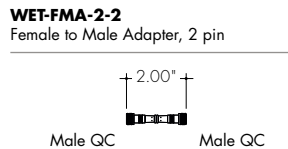
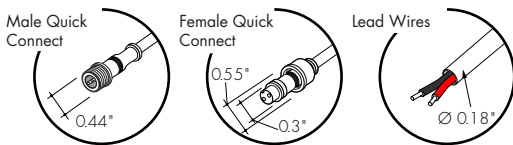

**For use with Tunable White (TW68), RGB Pixel (RGBX18) and RGBW Pixel (RGBW18):**

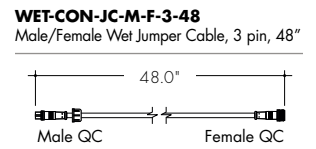
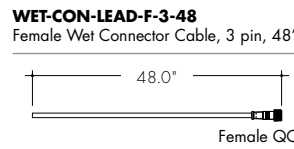
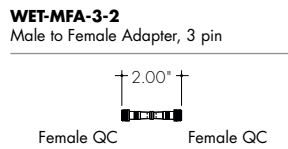
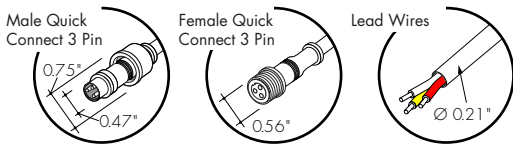

**For use with RGB (RGB42):**

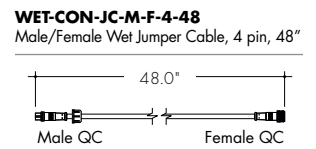
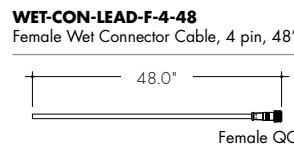
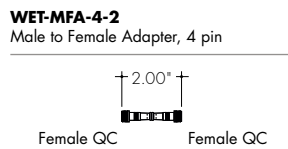
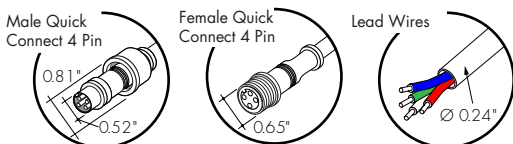

**For use with RGBW (RGBW36):**

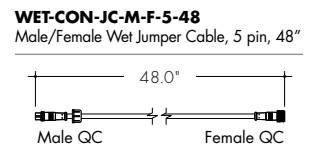
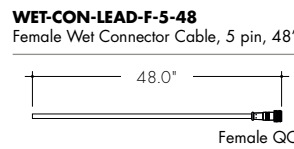
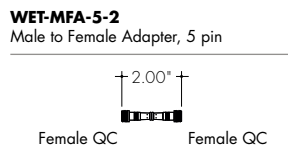
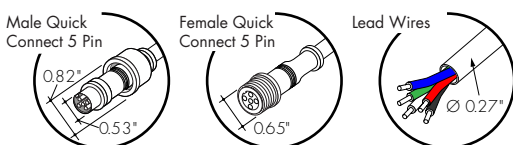

**Sample Layout**

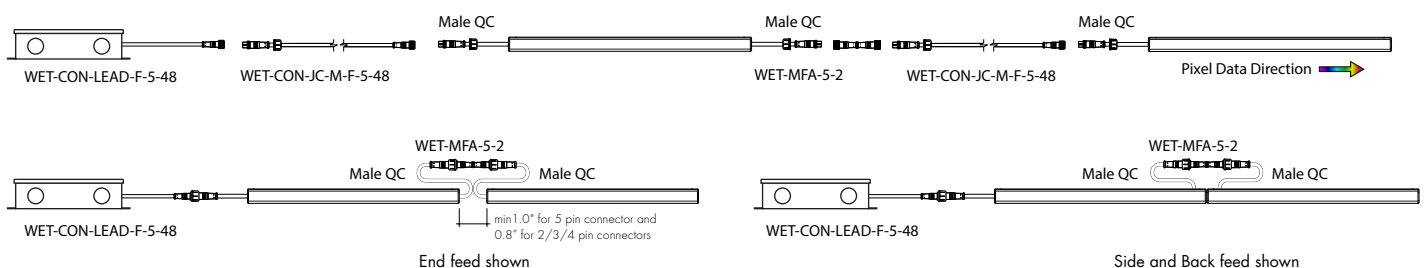



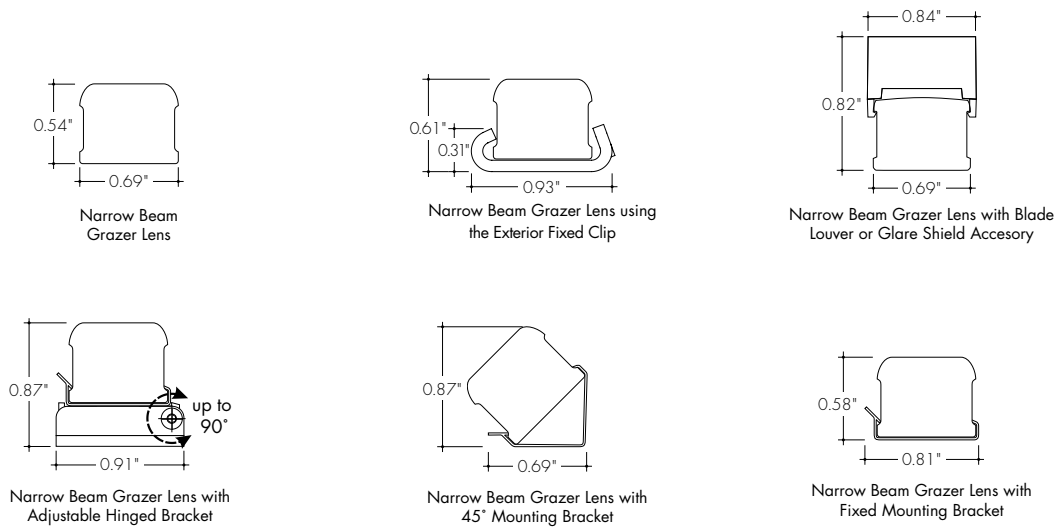



**Product Dimensions**

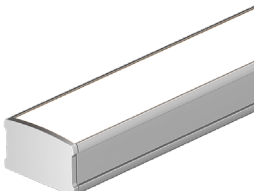

**Finish Options**

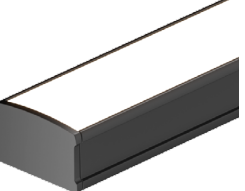
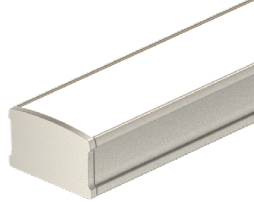
- Finish options are available in a wide variety, allowing for complete customization of style and aesthetic.
- Non Base finishes may have extended lead times and price adder.
- Polished Gold and Chrome finishes have a maximum fixture length of 96".
- Custom RALs are available, please consult Inside Sales with specific request.

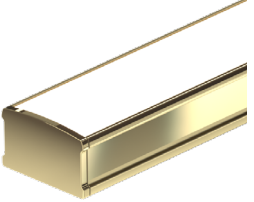
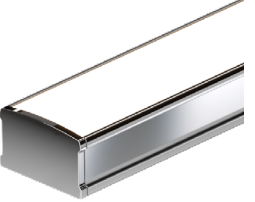
<p><b>Silver Anodized Base</b></p> 	<p><b>Black Powder Coat</b></p> 	<p><b>Bronze Powder Coat</b></p> 	<p><b>White Powder Coat</b></p> 	<p><b>Matte Black Premium</b></p> 
<p>Silver Anodized is a soft silver with a clear finish.</p>	<p>Black is a true deep black with a glossy finish.</p>	<p>Bronze is a rich, dark brown with a satin finish.</p>	<p>White is a polar bright white and field paintable.</p>	<p>Matte Black is a dark, pitch-black with a soft flat finish.</p>
<p><b>Warm Nickel Premium</b></p> 	<p><b>Aged Brass Premium</b></p> 	<p><b>Polished Gold Premium</b></p> 	<p><b>Chrome Premium</b></p> 	
<p>Warm Nickel is a soft, silvery smoke with warm tones and a satin finish.</p>	<p>Aged Brass is a deep brown shade with slightly golden undertones.</p>	<p>Polished Gold is bright and radiant for a brilliant finish.</p>	<p>Chrome is a highly reflective silver polish.</p>	

Light Transmission and Dotting

Output Options	Lens/Accessory											
	Narrow Beam Grazer Lens				Grazer Lens, White Glare Shield				Grazer Lens, White Blade Louver			
Dimming Level	100%	50%	10%	1%	100%	50%	10%	1%	100%	50%	10%	1%
WD68SO	CD	CD	CD	CD	CD	CD	CD	CD	CD	CD	CD	CD
TW68SO (All On)	CD	CD	CD	CD	CD	CD	CD	CD	CD	CD	CD	CD
TW68SO (1-Channel)	CD	CD	CD	CD	CD	CD	CD	CD	CD	CD	CD	CD
TW68HO (All On)	CD	CD	CD	CD	CD	CD	CD	CD	CD	CD	CD	CD
TW68HO (1-Channel)	CD	CD	CD	CD	CD	CD	CD	CD	CD	CD	CD	CD
RGBW36SO	CD	CD	CD	CD	CD	CD	CD	CD	CD	CD	CD	CD
RGBW36HO	CD	CD	CD	CD	CD	CD	CD	CD	CD	CD	CD	CD
RGB42SO	CD	CD	CD	CD	CD	CD	CD	CD	CD	CD	CD	CD
RGB42HO	CD	CD	CD	CD	CD	CD	CD	CD	CD	CD	CD	CD
RGBWX18SO	CD	CD	CD	CD	CD	CD	CD	CD	CD	CD	CD	CD
RGBX18SO	CD	CD	CD	CD	CD	CD	CD	CD	CD	CD	CD	CD
Transmission Percentage	100%				72%				54%			

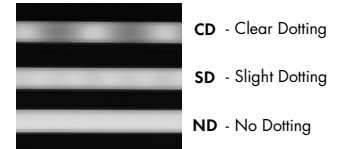

Accessory Options

**LV-GS-KMSC-24-XX**

Glare Shield reduces glare at high angle, field cuttable. Also available with complete fixture, use ordering code **-GSXX**

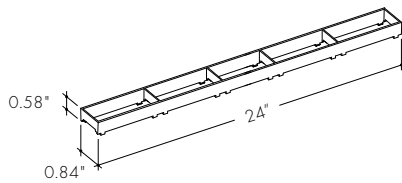

**LV-BL-KMSC-24-XX**

Blade Louver reduces glare at high angle in two directions. Also available with complete fixture, use ordering code **-BLXX**

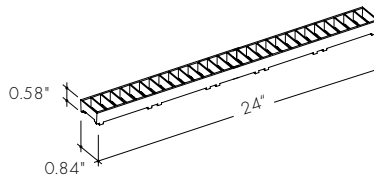

XX	Color
WH	White
BK	Black
SL	Silver

**LVSP-WET**

Splice box: wet rated, low voltage, gray

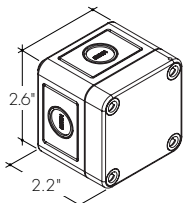

**LVSP-WET-CM**

Connector for splice box, low voltage for cable management, gray.

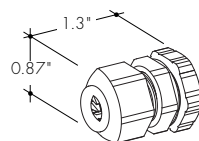

**Power Consumption**

Tested at Full Power with PS-UNI Series power supplies.

Standard Nominal Lengths offered provide minimal shadowing. For alternate lengths, please contact factory with specific request.

**Warm Dim (WD68)**

Nominal Length (in)	Actual Length	Watts SO	Nominal Length (in)	Actual Length	Watts SO	Nominal Length (in)	Actual Length	Watts SO	Nominal Length (in)	Actual Length	Watts SO
<b>12</b>	10 11/16	4.6	<b>47</b>	—	—	<b>82</b>	—	—	<b>117</b>	116 8/16	47.5
<b>13</b>	—	—	<b>48</b>	47 10/16	21.0	<b>83</b>	82 1/16	34.8	<b>118</b>	—	—
<b>14</b>	13 3/16	5.8	<b>49</b>	—	—	<b>84</b>	—	—	<b>119</b>	119	48.3
<b>15</b>	—	—	<b>50</b>	—	—	<b>85</b>	84 9/16	35.7	<b>120</b>	—	—
<b>16</b>	15 10/16	6.9	<b>51</b>	50 1/16	22.0	<b>86</b>	—	—	<b>121</b>	—	—
<b>17</b>	—	—	<b>52</b>	—	—	<b>87</b>	87	36.7	<b>122</b>	121 7/16	49.1
<b>18</b>	—	—	<b>53</b>	52 9/16	23.0	<b>88</b>	—	—	<b>123</b>	—	—
<b>19</b>	18 2/16	8.0	<b>54</b>	—	—	<b>89</b>	—	—	<b>124</b>	123 15/16	49.9
<b>20</b>	—	—	<b>55</b>	—	—	<b>90</b>	89 7/16	37.6	<b>125</b>	—	—
<b>21</b>	20 9/16	9.1	<b>56</b>	55	24.1	<b>91</b>	—	—	<b>126</b>	—	—
<b>22</b>	—	—	<b>57</b>	—	—	<b>92</b>	91 15/16	38.6	<b>127</b>	126 6/16	50.6
<b>23</b>	—	—	<b>58</b>	57 8/16	25.1	<b>93</b>	—	—	<b>128</b>	—	—
<b>24</b>	23	10.2	<b>59</b>	—	—	<b>94</b>	—	—	<b>129</b>	128 13/16	51.5
<b>25</b>	—	—	<b>60</b>	59 15/16	26.1	<b>95</b>	94 6/16	39.6	<b>130</b>	—	—
<b>26</b>	25 8/16	11.3	<b>61</b>	—	—	<b>96</b>	—	—	<b>131</b>	—	—
<b>27</b>	—	—	<b>62</b>	—	—	<b>97</b>	96 13/16	40.5	<b>132</b>	131 5/16	52.5
<b>28</b>	27 15/16	12.3	<b>63</b>	62 6/16	27.1	<b>98</b>	—	—	<b>133</b>	—	—
<b>29</b>	—	—	<b>64</b>	—	—	<b>99</b>	—	—	<b>134</b>	133 12/16	53.3
<b>30</b>	—	—	<b>65</b>	64 14/16	28.0	<b>100</b>	99 5/16	41.4	<b>135</b>	—	—
<b>31</b>	30 6/16	13.4	<b>66</b>	—	—	<b>101</b>	—	—	<b>136</b>	—	—
<b>32</b>	—	—	<b>67</b>	—	—	<b>102</b>	101 12/16	42.2	<b>137</b>	136 3/16	54.2
<b>33</b>	32 14/16	14.5	<b>68</b>	67 5/16	29.0	<b>103</b>	—	—	<b>138</b>	—	—
<b>34</b>	—	—	<b>69</b>	—	—	<b>104</b>	—	—	<b>139</b>	138 11/16	54.8
<b>35</b>	—	—	<b>70</b>	69 12/16	30.0	<b>105</b>	104 4/16	43.0	<b>140</b>	—	—
<b>36</b>	35 5/16	15.6	<b>71</b>	—	—	<b>106</b>	—	—	<b>141</b>	—	—
<b>37</b>	—	—	<b>72</b>	—	—	<b>107</b>	106 11/16	43.9	<b>142</b>	141 2/16	55.4
<b>38</b>	37 13/16	16.7	<b>73</b>	72 4/16	30.9	<b>108</b>	—	—	<b>143</b>	—	—
<b>39</b>	—	—	<b>74</b>	—	—	<b>109</b>	—	—	<b>144</b>	143 9/16	56.2
<b>40</b>	—	—	<b>75</b>	74 11/16	32.0	<b>110</b>	109 2/16	44.8			
<b>41</b>	40 4/16	17.8	<b>76</b>	—	—	<b>111</b>	—	—			
<b>42</b>	—	—	<b>77</b>	—	—	<b>112</b>	111 10/16	45.8			
<b>43</b>	42 11/16	18.9	<b>78</b>	77 2/16	33.1	<b>113</b>	—	—			
<b>44</b>	—	—	<b>79</b>	—	—	<b>114</b>	—	—			
<b>45</b>	—	—	<b>80</b>	79 10/16	33.9	<b>115</b>	114 1/16	46.6			
<b>46</b>	45 3/16	20.0	<b>81</b>	—	—	<b>116</b>	—	—			

**Power Consumption**

Tested at Full Power with PS-UNI Series power supplies.

Standard Nominal Lengths offered provide minimal shadowing. For alternate lengths, please contact factory with specific request.

**Tunable White (TW68)**

Nominal Length (in)	Actual Length	Watts		Nominal Length (in)	Actual Length	Watts		Nominal Length (in)	Actual Length	Watts		Nominal Length (in)	Actual Length	Watts	
		SO	HO			SO	HO			SO	HO			SO	HO
<b>12</b>	10 11/16	4.6	5.9	<b>47</b>	—	—	—	<b>82</b>	—	—	—	<b>117</b>	116 8/16	41.5	50.8
<b>13</b>	—	—	—	<b>48</b>	47 10/16	18.3	23.1	<b>83</b>	82 1/16	29.9	37.3	<b>118</b>	—	—	—
<b>14</b>	13 3/16	4.6	5.9	<b>49</b>	—	—	—	<b>84</b>	—	—	—	<b>119</b>	119	41.9	51.5
<b>15</b>	—	—	—	<b>50</b>	—	—	—	<b>85</b>	84 9/16	30.5	38.5	<b>120</b>	—	—	—
<b>16</b>	15 10/16	5.9	7.4	<b>51</b>	50 1/16	19.0	24.0	<b>86</b>	—	—	—	<b>121</b>	—	—	—
<b>17</b>	—	—	—	<b>52</b>	—	—	—	<b>87</b>	87	31.4	39.5	<b>122</b>	121 7/16	42.7	52.5
<b>18</b>	—	—	—	<b>53</b>	52 9/16	20.0	25.4	<b>88</b>	—	—	—	<b>123</b>	—	—	—
<b>19</b>	18 2/16	6.7	8.4	<b>54</b>	—	—	—	<b>89</b>	—	—	—	<b>124</b>	123 14/16	43.3	53.0
<b>20</b>	—	—	—	<b>55</b>	—	—	—	<b>90</b>	89 7/16	32.7	40.9	<b>125</b>	—	—	—
<b>21</b>	20 9/16	7.9	9.8	<b>56</b>	55	20.7	26.3	<b>91</b>	—	—	—	<b>126</b>	—	—	—
<b>22</b>	—	—	—	<b>57</b>	—	—	—	<b>92</b>	91 15/16	33.6	41.8	<b>127</b>	126 6/16	44.0	53.5
<b>23</b>	—	—	—	<b>58</b>	57 8/16	21.8	27.7	<b>93</b>	—	—	—	<b>128</b>	—	—	—
<b>24</b>	23	8.7	10.8	<b>59</b>	—	—	—	<b>94</b>	—	—	—	<b>129</b>	128 13/16	45.0	54.3
<b>25</b>	—	—	—	<b>60</b>	59 15/16	22.5	28.6	<b>95</b>	94 6/16	34.9	43.3	<b>130</b>	—	—	—
<b>26</b>	25 8/16	9.8	12.3	<b>61</b>	—	—	—	<b>96</b>	—	—	—	<b>131</b>	—	—	—
<b>27</b>	—	—	—	<b>62</b>	—	—	—	<b>97</b>	96 13/16	35.8	44.2	<b>132</b>	131 5/16	45.6	54.8
<b>28</b>	27 15/16	10.6	13.3	<b>63</b>	62 6/16	23.7	29.8	<b>98</b>	—	—	—	<b>133</b>	—	—	—
<b>29</b>	—	—	—	<b>64</b>	—	—	—	<b>99</b>	—	—	—	<b>134</b>	133 12/16	46.5	55.7
<b>30</b>	—	—	—	<b>65</b>	64 14/16	24.6	30.6	<b>100</b>	99 5/16	36.4	44.8	<b>135</b>	—	—	—
<b>31</b>	30 6/16	11.8	14.8	<b>66</b>	—	—	—	<b>101</b>	—	—	—	<b>136</b>	—	—	—
<b>32</b>	—	—	—	<b>67</b>	—	—	—	<b>102</b>	101 12/16	37.4	45.7	<b>137</b>	136 3/16	46.8	56.3
<b>33</b>	32 14/16	12.6	15.8	<b>68</b>	67 5/16	25.4	31.3	<b>103</b>	—	—	—	<b>138</b>	—	—	—
<b>34</b>	—	—	—	<b>69</b>	—	—	—	<b>104</b>	—	—	—	<b>139</b>	138 11/16	47.3	57.4
<b>35</b>	—	—	—	<b>70</b>	69 12/16	26.7	32.4	<b>105</b>	104 4/16	38.0	46.3	<b>140</b>	—	—	—
<b>36</b>	35 5/16	13.4	16.8	<b>71</b>	—	—	—	<b>106</b>	—	—	—	<b>141</b>	—	—	—
<b>37</b>	—	—	—	<b>72</b>	—	—	—	<b>107</b>	106 11/16	39.0	47.2	<b>142</b>	141 2/16	47.6	58.1
<b>38</b>	37 13/16	14.5	18.3	<b>73</b>	72 4/16	27.6	33.1	<b>108</b>	—	—	—	<b>143</b>	—	—	—
<b>39</b>	—	—	—	<b>74</b>	—	—	—	<b>109</b>	—	—	—	<b>144</b>	143 9/16	48.1	59.1
<b>40</b>	—	—	—	<b>75</b>	74 11/16	28.4	34.3	<b>110</b>	109 2/16	39.7	47.8				
<b>41</b>	40 4/16	15.3	19.3	<b>76</b>	—	—	—	<b>111</b>	—	—	—				
<b>42</b>	—	—	—	<b>77</b>	—	—	—	<b>112</b>	111 10/16	40.3	48.9				
<b>43</b>	42 11/16	16.4	20.7	<b>78</b>	77 2/16	28.9	35.2	<b>113</b>	—	—	—				
<b>44</b>	—	—	—	<b>79</b>	—	—	—	<b>114</b>	—	—	—				
<b>45</b>	—	—	—	<b>80</b>	79 10/16	29.5	36.4	<b>115</b>	114 1/16	40.8	49.7				
<b>46</b>	45 3/16	17.2	21.7	<b>81</b>	—	—	—	<b>116</b>	—	—	—				

**Power Consumption**

Tested at Full Power with PS-UNI Series power supplies.

Standard Nominal Lengths offered provide minimal shadowing. For alternate lengths, please contact factory with specific request.

**RGB/RGBW (RGB42/RGBW36)**

Nominal Length (in)	Actual Length	Watts				Nominal Length (in)	Actual Length	Watts				Nominal Length (in)	Actual Length	Watts				Nominal Length (in)	Actual Length	Watts			
		RGBW36		RGB42				RGBW36		RGB42				RGBW36		RGB42				RGBW36		RGB42	
		SO	HO	SO	HO			SO	HO	SO	HO			SO	HO	SO	HO			SO	HO	SO	HO
12	10 11/16	4.0	7.3	4.4	8.6	47	46 2/16	14.4	27.5	16.8	31.3	82	81 9/16	26.1	49.6	29.4	53.8	117	-	-	-	-	
13	12 11/16	4.0	7.3	4.4	8.6	48	-	-	-	-	-	83	-	-	-	-	-	118	117	37.1	66.2	41.3	73.1
14	-	-	-	-	-	49	48 2/16	15.1	28.8	17.5	32.7	84	83 9/16	26.8	50.8	30.0	55.0	119	119	37.8	67.5	41.9	74.0
15	14 10/16	4.5	8.5	5.2	10.0	50	-	-	-	-	-	85	-	-	-	-	-	120	-	-	-	-	
16	-	-	-	-	-	51	50 1/16	15.8	30.0	18.3	34.0	86	85 8/16	27.4	51.9	30.7	56.2	121	120 15/16	38.6	68.7	42.6	74.9
17	16 10/16	5.1	9.7	5.9	11.3	52	-	-	-	-	-	87	-	-	-	-	-	122	-	-	-	-	
18	-	-	-	-	-	53	52 1/16	16.4	31.2	18.9	35.1	88	87 8/16	28.0	52.9	31.4	57.3	123	122 15/16	39.2	69.7	43.2	75.3
19	18 9/16	5.6	10.9	6.7	12.6	54	-	-	-	-	-	89	-	-	-	-	-	124	-	-	-	-	
20	-	-	-	-	-	55	54	17.0	32.4	19.6	36.3	90	89 7/16	28.6	53.8	32.2	58.4	125	124 14/16	39.7	70.7	43.8	75.7
21	20 9/16	6.2	12.1	7.4	13.9	56	56	17.6	33.5	20.3	37.5	91	-	-	-	-	-	126	-	-	-	-	
22	-	-	-	-	-	57	-	-	-	-	-	92	91 7/16	29.2	54.8	32.9	59.5	127	126 14/16	40.3	71.7	44.4	76.1
23	22 8/16	6.7	13.3	8.2	15.2	58	57 15/16	18.2	34.7	21.0	38.7	93	-	-	-	-	-	128	-	-	-	-	
24	-	-	-	-	-	59	-	-	-	-	-	94	93 6/16	29.9	55.8	33.6	60.5	129	128 13/16	40.8	72.8	45.0	76.6
25	24 8/16	7.3	14.5	8.9	16.6	60	59 15/16	18.9	35.9	21.7	39.8	95	-	-	-	-	-	130	-	-	-	-	
26	-	-	-	-	-	61	-	-	-	-	-	96	95 6/16	30.2	56.3	34.0	61.1	131	130 13/16	41.4	73.8	45.6	77.0
27	26 7/16	8.0	15.7	9.6	18.0	62	61 14/16	19.5	37.1	22.4	41.1	97	-	-	-	-	-	132	-	-	-	-	
28	-	-	-	-	-	63	-	-	-	-	-	98	97 5/16	30.8	57.2	34.7	62.2	133	132 12/16	41.9	74.8	46.3	77.4
29	28 7/16	8.6	17.0	10.4	19.4	64	63 14/16	20.2	38.4	23.2	42.4	99	-	-	-	-	-	134	-	-	-	-	
30	-	-	-	-	-	65	-	-	-	-	-	100	99 5/16	31.3	57.9	35.4	63.4	135	134 12/16	42.5	75.5	46.8	78.1
31	30 6/16	9.3	18.2	11.1	20.7	66	65 13/16	20.8	39.7	24.0	43.7	101	-	-	-	-	-	136	-	-	-	-	
32	-	-	-	-	-	67	-	-	-	-	-	102	101 4/16	31.9	58.6	36.0	64.7	137	136 11/16	43.1	76.3	47.3	78.8
33	32 6/16	9.7	18.8	11.5	21.4	68	67 13/16	21.5	41.0	24.7	45.1	103	-	-	-	-	-	138	-	-	-	-	
34	-	-	-	-	-	69	-	-	-	-	-	104	103 4/16	32.4	59.3	36.7	65.9	139	138 11/16	43.7	77.0	47.8	79.6
35	34 5/16	10.3	20.0	12.2	22.8	70	69 12/16	22.1	42.3	25.5	46.4	105	-	-	-	-	-	140	-	-	-	-	
36	-	-	-	-	-	71	-	-	-	-	-	106	105 3/16	32.9	60.0	37.3	67.2	141	140 10/16	44.3	77.7	48.3	80.3
37	36 5/16	11.0	21.3	13.0	24.2	72	71 12/16	22.8	43.5	26.3	47.8	107	-	-	-	-	-	142	-	-	-	-	
38	-	-	-	-	-	73	-	-	-	-	-	108	107 3/16	33.5	60.7	38.0	68.4	143	142 10/16	44.9	78.5	48.8	81.0
39	38 4/16	11.7	22.5	13.7	25.6	74	73 11/16	23.5	44.8	26.9	49.0	109	-	-	-	-	-	144	-	-	-	-	
40	-	-	-	-	-	75	-	-	-	-	-	110	109 2/16	34.0	61.4	38.6	69.7						
41	40 4/16	12.4	23.8	14.5	27.0	76	75 11/16	24.1	46.0	27.6	50.2	111	-	-	-	-	-						
42	-	-	-	-	-	77	-	-	-	-	-	112	111 2/16	34.8	62.6	39.3	70.5						
43	42 3/16	13.1	25.0	15.2	28.5	78	77 10/16	24.8	47.2	28.2	51.4	113	-	-	-	-	-						
44	-	-	-	-	-	79	-	-	-	-	-	114	113 1/16	35.6	63.8	39.9	71.4						
45	44 3/16	13.8	26.3	16.0	29.9	80	79 10/16	25.4	48.4	28.8	52.6	115	-	-	-	-	-						
46	-	-	-	-	-	81	-	-	-	-	-	116	115 1/16	36.3	65.0	40.6	72.3						

**Power Consumption**

Tested at Full Power with PS-UNI Series power supplies.

Standard Nominal Lengths offered provide minimal shadowing. For alternate lengths, please contact factory with specific request.

**PIXEL**

Nominal Length (in)	Actual Length	Watts		Nominal Length (in)	Actual Length	Watts		Nominal Length (in)	Actual Length	Watts		Nominal Length (in)	Actual Length	Watts	
		RGBX18	RGBWX18			RGBX18	RGBWX18			RGBX18	RGBWX18			RGBX18	RGBWX18
		SO	SO			SO	SO			SO	SO			SO	SO
12	8 12/16	4.6	5.7	47	—	—	—	82	—	—	—	117	—	—	—
13	12 11/16	4.6	5.7	48	—	—	—	83	—	—	—	118	—	—	—
14	—	—	—	49	48 2/16	17.4	21.9	84	83 9/16	29.8	37.1	119	119	40.9	51.2
15	—	—	—	50	—	—	—	85	—	—	—	120	—	—	—
16	—	—	—	51	—	—	—	86	—	—	—	121	—	—	—
17	16 10/16	6.1	7.5	52	—	—	—	87	—	—	—	122	—	—	—
18	—	—	—	53	52 1/16	18.9	23.7	88	87 8/16	31.1	38.7	123	122 15/16	42.1	52.8
19	—	—	—	54	—	—	—	89	—	—	—	124	—	—	—
20	—	—	—	55	—	—	—	90	—	—	—	125	—	—	—
21	20 9/16	7.6	9.4	56	56	20.3	25.4	91	—	—	—	126	—	—	—
22	—	—	—	57	—	—	—	92	91 7/16	32.4	40.3	127	126 14/16	43.3	54.3
23	—	—	—	58	—	—	—	93	—	—	—	128	—	—	—
24	—	—	—	59	—	—	—	94	—	—	—	129	—	—	—
25	24 8/16	9.1	11.3	60	59 15/16	21.7	27.1	95	—	—	—	130	—	—	—
26	—	—	—	61	—	—	—	96	95 6/16	33.4	41.6	131	130 13/16	44.5	55.9
27	—	—	—	62	—	—	—	97	—	—	—	132	—	—	—
28	—	—	—	63	—	—	—	98	—	—	—	133	—	—	—
29	28 7/16	10.6	13.2	64	63 14/16	23.0	28.8	99	—	—	—	134	—	—	—
30	—	—	—	65	—	—	—	100	99 5/16	34.6	43.2	135	134 12/16	45.7	57.4
31	—	—	—	66	—	—	—	101	—	—	—	136	—	—	—
32	—	—	—	67	—	—	—	102	—	—	—	137	—	—	—
33	32 6/16	11.7	14.6	68	67 13/16	24.4	30.5	103	—	—	—	138	—	—	—
34	—	—	—	69	—	—	—	104	103 4/16	35.9	44.8	139	138 11/16	46.9	58.9
35	—	—	—	70	—	—	—	105	—	—	—	140	—	—	—
36	—	—	—	71	—	—	—	106	—	—	—	141	—	—	—
37	36 5/16	13.1	16.5	72	71 12/16	25.8	32.3	107	—	—	—	142	—	—	—
38	—	—	—	73	—	—	—	108	107 3/16	37.2	46.4	143	142 10/16	48.0	60.4
39	—	—	—	74	—	—	—	109	—	—	—	144	—	—	—
40	—	—	—	75	—	—	—	110	—	—	—	—	—	—	—
41	40 4/16	14.6	18.3	76	75 11/16	27.1	33.9	111	—	—	—	—	—	—	—
42	—	—	—	77	—	—	—	112	111 2/16	38.4	48.0	—	—	—	—
43	—	—	—	78	—	—	—	113	—	—	—	—	—	—	—
44	—	—	—	79	—	—	—	114	—	—	—	—	—	—	—
45	44 3/16	16.0	20.1	80	79 10/16	28.4	35.5	115	—	—	—	—	—	—	—
46	—	—	—	81	—	—	—	116	115 1/16	39.7	49.6	—	—	—	—



### Voltage Drop Calculator

The below chart assumes nominal voltage of 24 Volts and a Voltage Drop Allowance of 3% through the wire

Wattage [W]	Wire Length From Power Supply to Start of Run [ft]						
	12 AWG	14 AWG	16 AWG	18 AWG	20 AWG	22 AWG	24 AWG
<b>5</b>	1088.2	684.4	430.3	270.6	170.2	107.1	67.3
<b>10</b>	544.1	342.2	215.1	135.3	85.1	53.5	33.7
<b>15</b>	362.7	228.1	143.4	90.2	56.7	35.7	22.4
<b>20</b>	272.0	171.1	107.6	67.7	42.6	26.8	16.8
<b>25</b>	217.6	136.9	86.1	54.1	34.0	21.4	13.5
<b>30</b>	181.4	114.1	71.7	45.1	28.4	17.8	11.2
<b>35</b>	155.5	97.8	61.5	38.7	24.3	15.3	9.6
<b>40</b>	136.0	85.5	53.8	33.8	21.3	13.4	8.4
<b>45</b>	120.9	76.0	47.8	30.1	18.9	11.9	7.5
<b>50</b>	108.8	68.4	43.0	27.1	17.0	10.7	6.7
<b>55</b>	98.9	62.2	39.1	24.6	15.5	9.7	6.1
<b>60</b>	90.7	57.0	35.9	22.6	14.2	8.9	5.6
<b>65</b>	83.7	52.6	33.1	20.8	13.1	8.2	5.2
<b>70</b>	77.7	48.9	30.7	19.3	12.2	7.6	4.8
<b>75</b>	72.5	45.6	28.7	18.0	11.3	7.1	4.5
<b>80</b>	68.0	42.8	26.9	16.9	10.6	6.7	4.2
<b>85</b>	64.0	40.3	25.3	15.9	10.0	6.3	4.0
<b>90</b>	60.5	38.0	23.9	15.0	9.5	5.9	3.7
<b>96</b>	56.7	35.6	22.4	14.1	8.9	5.6	3.5

## Power Supplies

See fixture and power supply instructions & spec sheet for wiring information. Dimming possible in select models - view Luminii website for list of compatible dimmers.

### For use with Warm Dim, WD68

#### Ordering Code Phase Dimming Power Supply 1% 120VAC - 277VAC

MODEL	INPUT CONTROL	ENVIRONMENT	WATTAGE	OUTPUT	OUTPUT CONTROL
PS - Power Supply, 120-277VAC	PH - Phase Dimming (Triac, ELV, MLV)	D - Dry	96 - 96 Watts	24 - 24 VDC	DC - Direct Current

MLV/ELV/TRIAC - 1% dimming, consult dimming compatibility chart [\(Link\)](#)

MODELS	96W
Length	8.25"
Width	4.10"
Depth	1.56"

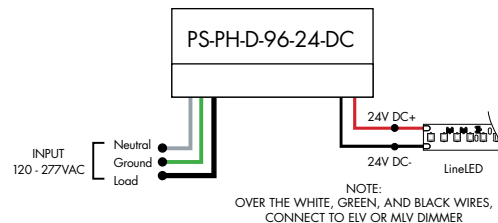

### For use with Tunable White, TW68

#### Ordering Code DALI2 Dimming Power Supplies 0.1% 120VAC - 277VAC

MODEL	INPUT CONTROL	ENVIRONMENT	WATTAGE	OUTPUT	OUTPUT CONTROL
PS - Power Supply, 120-277VAC	DALI-DT8 - DALI DT8 Tunable White (0.1%)	D - Dry	96 - 96 Watts	24 - 24 VDC	PWM - Pulse Width Modulation

MODELS	96W
Length	14.40"
Width	5.20"
Depth	2.60"

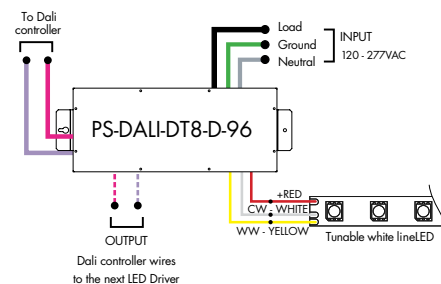

### Athena DALI2-DT8 LED Driver

MODEL	INPUT CONTROL	ENVIRONMENT	WATTAGE	OUTPUT	FEATURE
PS - Power Supply, 120-277VAC	DALI-DT8 - DALI DT8 Tunable White	D - Dry	96 - 96 W	24 - 24 VDC	AWNR - Athena

MODELS	96W
Length	14.40"
Width	5.20"
Depth	2.60"

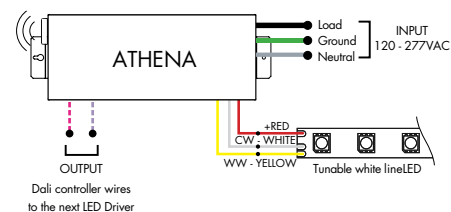

### Power Supplies

See fixture and power supply instructions & spec sheet for wiring information. Dimming possible in select models - view Luminii website for list of compatible dimmers.

### For use with Tunable White, TW68

### Ordering Code VintageDim® 0 - 10V Dimming Power Supplies 120VAC - 277VAC

MODEL	INPUT CONTROL	ENVIRONMENT	WATTAGE	OUTPUT
PS - Power Supply, 120-277VAC	010V-WD - 0-10V Dimming, Standard Warm Dim Curve (with Tunable White LED) 010V-TW - 0-10V Dimming, Two Channel Control, Brightness and CCT1-CCT2 Ratio 010V-2CH - 0-10V Dimming, Two Channel Control, LED1 Brightness and LED2 Brightness 010V-WDX - 0-10V Dimming, Customizable Warm Dim Curve (with Tunable White LED) 010V-2CHX - 0-10V Dimming, Two Channel Control, Customizable Brightness and CCT1-CCT2 Ratio	D-Dry	96 - 96 Watts 3X96 - 3x96 Watts <sup>1</sup>	24 - 24 VDC

1 - 3x96 is only available with input control options 010V-WD and 010V-TW  
 2 - Athena only available on 96 watts option

MODELS	96W	3X96
Length	14.40"	15.00"
Width	5.20"	6.62"
Depth	2.60"	4.56"

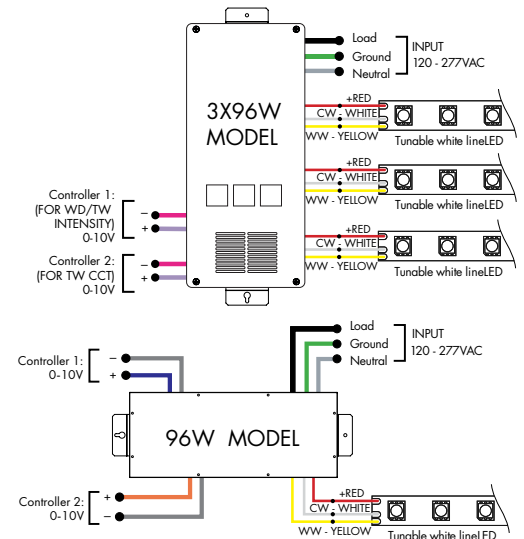

### Athena 0-10V Warm Dim LED Driver

MODEL	INPUT CONTROL	ENVIRONMENT	WATTAGE	OUTPUT	FEATURE
PS - Power Supply, 120-277VAC	010V-WD - 0-10V Dimming, Standard Warm Dim Curve (with Dynamic White LED)	D-Dry	96-96 W	24-24 VDC	AWN - Athena

MODELS	96W
Length	14.40"
Width	5.20"
Depth	2.60"

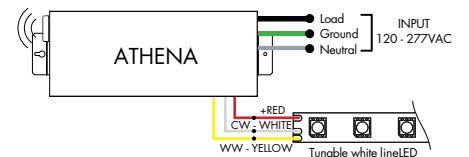

### Athena 0-10V Two Channel LED Driver

MODEL	INPUT CONTROL	ENVIRONMENT	WATTAGE	OUTPUT	FEATURE
PS - Power Supply, 120-277VAC	010V-2CH - 0-10V Dimming Two Channel Control, LED1 Brightness and LED2 Brightness	D-Dry	96-96 W	24-24 VDC	AWN - Athena

MODELS	96W
Length	14.40"
Width	5.20"
Depth	2.60"

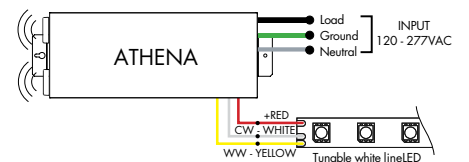

### Power Supplies

See fixture and power supply instructions & spec sheet for wiring information. Dimming possible in select models - view Luminii website for list of compatible dimmers.

**For use with RGB/RGBW, RGB42/RGBW36 or with Tunable White, TW68**

Requires Controller

#### Ordering Code DMX Dimming Power Supplies 0.1% 120VAC - 277VAC

MODEL	INPUT CONTROL	ENVIRONMENT	WATTAGE	OUTPUT
PS-Power Supply, 120-277VAC	DMX-DMX (0.1%)	D-Dry	96-96 Watts 3X96-3X96 Watts	24-24 VDC

MODELS	96W	3X96
<b>Length</b>	14.40"	15.00"
<b>Width</b>	5.20"	6.62"
<b>Depth</b>	2.60"	4.56"

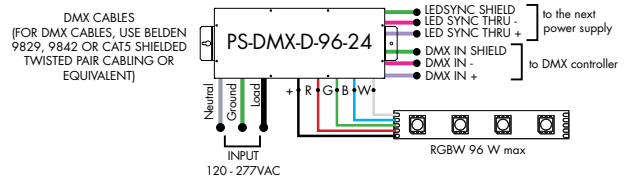
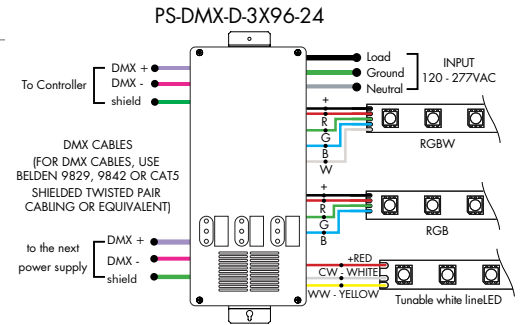

**For use with RGB/RGBW/Pixel, RGB42/RGBW36/RGBX18/RGBWX18**

Requires Controller and Decoder

#### Ordering Code Non-Dimming Power Supply 120VAC - 277VAC

MODEL	INPUT CONTROL	ENVIRONMENT	WATTAGE	OUTPUT
PS-Power Supply, 120-277VAC	ND-Non Dimming	D-Dry	96-96 Watts	24-24 VDC

MODELS	96W
<b>Length</b>	14.40"
<b>Width</b>	5.20"
<b>Depth</b>	2.60"

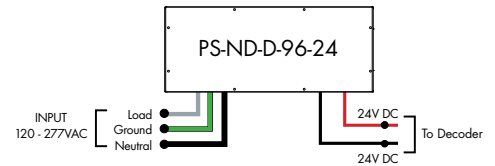

**For use with RGB/RGBW/Pixel, RGB42/RGBW36/RGBX18/RGBWX18**

Requires Controller and Decoder

#### Ordering Code Universal Dimming Power Supplies 1% 120VAC - 277VAC

MODEL	INPUT CONTROL	ENVIRONMENT	WATTAGE	OUTPUT
PS-Power Supply, 120-277VAC	UNI-0-10V Dimming, Phase Dimming	D-Dry W-Wet	30-30 Watts 60-60 Watts 96-96 Watts 3x96-3x96 Watts	24-24 VDC

Compatibility: View a complete list of compatible dimmers on product page [\(Link\)](#)

0-10V - 1% dimming  
MLV/ELV/TRIAC - 1% dimming, consult dimming compatibility chart

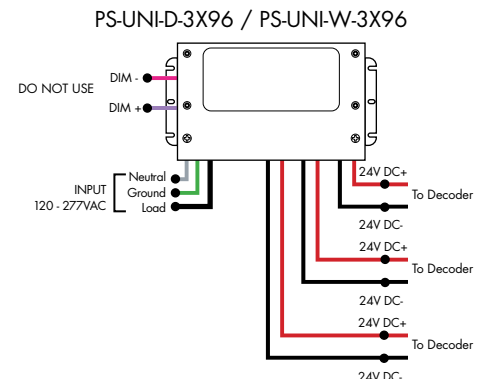
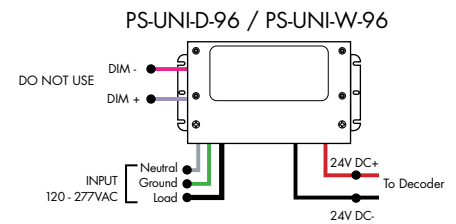

MODELS	PS-UNI-W-30W	PS-UNI-W-60W	PS-UNI-W-96W	PS-UNI-W-3X96W
<b>Length</b>	6.50"	7.40"	8.66"	11.85"
<b>Width</b>	3.73"	3.73"	3.73"	4.32"
<b>Depth</b>	1.61"	1.61"	1.61"	1.81"

MODELS	PS-UNI-D-30W	PS-UNI-D-60W	PS-UNI-D-96W	PS-UNI-D-3X96W
<b>Length</b>	8.77"	8.77"	8.11"	9.94"
<b>Width</b>	4.27"	4.27"	5.60"	7.61"
<b>Depth</b>	1.83"	1.83"	1.83"	2.02"

**Controllers and Decoders**

**For use with Tunable White Power Supplies**



MODEL

**DTW-MC**

DTW-MC - Tunable White controller

Tunable White wall-mount controller controls lighting fixtures, wireless control of TW lighting fixture. Fits in any standard US switch box. Includes all the outputs in the back of the controller.

**Features**

- Switch & dimming control function, control range > 20M.
- Smooth transition between light levels.
- Separately operate dimming and color temperature functions.
- Able to control 1 zone with endless receivers. Each receiver can maximally be controlled by 8 remotes.
- Power, temperature color and dimming functions operated by push button after receivers are connected.

**Operating Voltage**

3V DC battery

**Color Parameters**

- Brightness
- Saturation
- Fading



MODEL

**TW-DMX**

TW-DMX - DMX controller

Tunable White DMX wall-mount controller is a fully touch sensitive controller designed in accordance with standard protocol DMX512. Offers fast and accurate color temperature adjustment and brightness dimming of natural white, warm white and cold white. Designed with a touch color wheel, the DMX512 controller can adjust color temperature and brightness for all white LEDs smoothly and accurately. The DMX controller can control 1 zone with endless decoders.

**Features**

- 1 zone
- 6 color scenes
- DMX Control
- Touch Sensitive Glass Surface
- Dimming and Speed Control
- Memory Function
- Easily Fits Standard US Switch Boxes

**Operating Voltage**

12 - 24V DC

**Color Parameters**

- Brightness
- Saturation
- Primary colors
- Fading
- Color changing speed



MODEL

**SLD-DIMTW**

SLD-DIMTW - Tunable white LED dimming module

The SLD DimTW is a constant voltage warm dimming LED dimming module. The unique dimming module accepts 0-10V control and mimics a smooth, incandescent dimming curve.

**Features**

- Flicker free 0-100% dimming
- High efficiency up to 97%
- High precision dimming ratio:>1:1000
- Fully isolated plastic housing
- Comply with EN55015 and FCC part 15 without additional input filter and capacitors
- compact size, high reliability
- 3 years warranty

**Operating Voltage**

8-48 VDC

## Controllers and Decoders

### For use with Tunable White, RGB/RGBW Power Supplies



MODEL

**RGBW-RC-R**

RGBW-RC-R - RGBW receiver

The RGBW receiver is easily paired with controller by the click of a button. Receiver can be reset to factory settings at any time.

Each receiver can store one static RGB color, one color sequence, and one brightness setting for the white LED strip. Receivers assigned to the same scene within the same zone will have the same LED static color and color sequence.

**Operating Voltage**  
12-36 VDC

**Power Capacity**  
up to 96W at 24V

**Operating Temperature Range**  
from -4°F to +122°F in case



MODEL

**RGBW-SR**

RGBW-SR - RGBW signal repeater

Extends identical signal when connected in series to an RGBW LED control system. The RGBW signal repeater works with Luminii RGB and RGBW controllers, receivers, and decoders.

RGBW signal can be extended indefinitely when adequate power supply (not included) is connected to the system.

**Operating Voltage**  
12-36 VDC

**Power Capacity**  
up to 96W at 24V

**Operating Temperature Range**  
from -4°F to +122°F in case



MODEL

**DDMX-RGBW**

DDMX-RGBW - DMX decoder

Translates controller DMX512 programs for RGB and white LED strips.

Unique DMX address for the decoder can be set easily and displayed by the numeric display on the case. Changing and resetting the DMX address requires manual input.

Use power repeater to expand output.

**Operating Voltage**  
12-36 VDC

**Power Capacity**  
up to 96W at 24V

**Operating Temperature Range**  
from -4°F to +122°F in case

## Controllers and Decoders

### For use with RGB/RGBW Power Supplies



MODEL

**RGBW-MC3**

RGBW-MC3 - 4-zone RGBW controller

Easy to operate wireless interface suitable for static or color changing scenes. Control 4 different color zones separately or at the same time. RGBW receiver (RGBW-RC-R) required for operation. Assign multiple receivers per zone to cover a large area.

Color wheel enables highly stable and sensitive color control functionality. Create your own color changing sequences with ease and flexibility.

**Power**

qty 3 AAA batteries

**Scenes**

up to 4 unique zones

**Signal**

Wireless (RF)

**Energy Saving**

Deactivates after 10 seconds of inactivity

**Color Parameters**

- Brightness
- Saturation
- Primary colors
- Speed of color changing sequence
- Fading

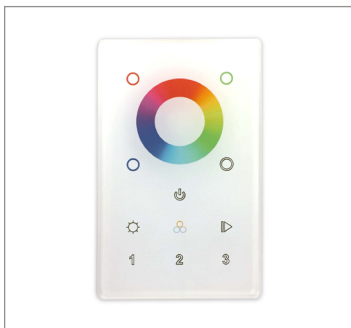

MODEL

ZONES

COLOR

DMX - DMX Controller

3Z - Three Zone  
1Z - One Zone

RGBW - Red, Green, Blue, & White

DMX /Wireless RGB-W wall-mount controller controls DMX lighting fixtures, wireless control of RGB-W lighting fixture or use both simultaneously. Fits in any standard US switch box. Includes all the outputs in the back of the controller.

Control brightness levels with a single touch, personalize and memorize 3 different scenes, and even create 3 variations of white.

**Features**

- 2 in 1 in-Wall Controller: DMX Control or Wireless RGB-W
- 65,000 Color Options, Dimming and Speed Control
- Memory Function
- 50 Foot Wireless Range
- Easily Fits Standard US Switch Boxes
- Touch Sensitive Glass Surface
- Includes 10 Built in Programs, or Create and Play Your Own

**Operating Voltage**

12 - 24V DC

**Color Parameters**

- Brightness
- Saturation
- Primary colors
- Fading
- Color changing speed

### For use with Tunable White, RGB/RGBW, Pixel Power Supplies

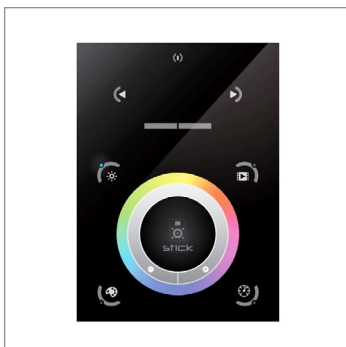

MODEL

**TSDMX-E**

TSDMX-E - Touchscreen DMX controller

Programmable advanced DMX512 lighting controller featuring a touch-screen interface. Operates as stand alone controller or integrated with most architectural lighting control systems. Can controller endless DMX512 enabled devices.

Mounts to standard single or dual gang wall box with the included power supply inside the junction box. Terminal block design for power and data connections.

**Features**

- Sleek glass design which sits 0.43" from the wall
- Graphical color display to show selected environment
- Color/dimmer/speed palette
- Color temperature mixing
- Touch sensitive buttons. No mechanical parts
- Touch sensitive wheel allows for accurate color selection
- Multi-zone microSD memory
- Multi-room control with 500 scenes, 10 zones
- 1024 DMX channels. Control 340 RGB fixtures
- USB & Ethernet connectivity for programming and control

**Power Supply**

7 VDC (included)

**Programmability**

PC, Mac, Tablet, Smartphone

**Output Signal**

DMX512 (1024 channels)

**Color Parameters**

- Brightness
- Saturation
- Speed of color changing sequence
- Fading / dimming / brightness

**Controllers and Decoders**

**For use with Pixel Power Supplies**



MODEL

**SR-DMX-SPI**

SR-DMX-SPI - Smart Pixel Decoder

The SR-DMX-SPI is a smart LED pixel decoder that controls RGB/RGBW pixel LED strips with SPI signal. Designed with an OLED backlit panel, the pixel controller allows for easy configuration of most settings. Four push buttons are available for control of the LED functions.  
\*For pixel only.

**Features**

- 2 in 1 in-Wall Controller: DMX Control or Wireless RGB-W
- SPI signal output for RGB/RGBW pixel light control
- DMX512 controllable and RF/WIFI remote controllable
- Capable of addressing up to 1020 RGB pixels & 765 RGBW pixels
- OLED panel allows for easy configuration

**Operating Voltage**

12 - 36V DC

**Power capacity**

up to 96W at 24V

**Operating temperature range**

from -4°F to +122°F in case

**For use with Tunable White, RGB/RGBW Power Supplies**



MODEL

**DDMX-5CH-RDM-PRO**

DDMX-5CH-RDM-PRO-DMX512 Decoder

DMX512 decoder with RDM functionality features 5 PWM output channels with common anode. High PWM output frequency range allows the product to be used in HD video conferencing spaces. All DMX products to be installed per DMX512 Standard.

**Power**

96 Watt

**Inputs**

RJ45, XLR-5Pin, Terminal Block

**DMX Channels**

1 to 5 settable

**PWM Output Resolution Ratio**

8 or 16 bit

**PWM Output Frequency**

500Hz - 30KHz

**Output Dimming Curve Gamma Value**

0.1 ~ 9.9



MODEL

**RGBW-WI-R**

RGBW-WI-R - WIFI generator

RGBW-WI-R creates a local network that enables any electronic device (phone, tablet, etc.) to control the RGB/W strip connected to a RGBW-RC-R receiver.

The control functions are achieved through a free application download for Android and iOS devices called REALCOLOR.

**Operating Voltage**

12-36 VDC

**Power Supply**

PI-130-24 (included)

**Operating Temperature Range**

from -4°F to +122°F in case