

**Features**

The KRS Channel is a linear aluminum extrusion that has been designed to fit many recess-mount LED lighting needs. The discrete profile and neutral finish allow for the perfect fit in multiple mounting surfaces for any application. Channels come with specified Mounting Clips and End Caps.

**Finish**

Silver anodized, White, Black, Bronze

**Diffuser Lens**

Polycarbonate, snap-in-place, UV resistant

**Mounting**

Multiple mounting Clips

**Warranty**

7 Years



**Product Dimensions**

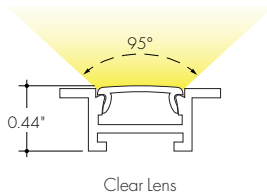
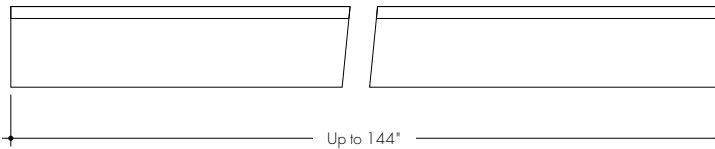
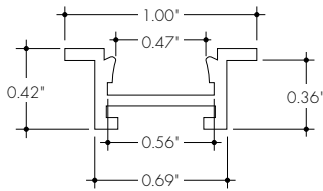

Clear Lens

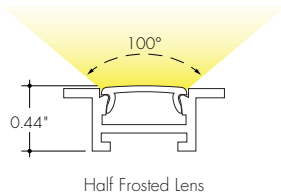

Half Frosted Lens

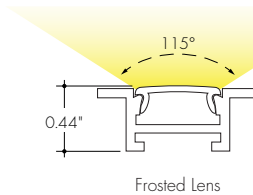

Frosted Lens

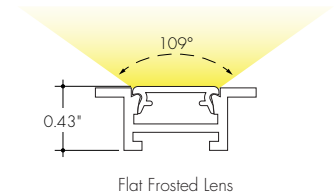

Flat Frosted Lens

**INCLUDED MOUNTING ACCESSORIES**

EXTRUSION LENGTH	HARD SURFACE	GYPSUM SURFACE	ENDCAP PAIR
48"	2	6	1
72"	3	6	1
96"	4	8	1
120"	5	10	1
144"	5	10	1

**TRANSMISSION PERCENTAGE**  
(COMPARED TO LED TAPE WITHOUT CHANNEL)

LENS	TRANSMISSION %
Clear	86%
Half Frosted	71%
Flat Frosted	60%
Frosted	56%

See LED tape spec sheet for lens dotting characteristics & compatibility

Each pair of endcaps includes 2x H3 (no wire feed hole) end caps where applicable. Additional endcaps and mounting clips are available for purchase.

**Ordering code**

MODEL	LENGTH	LENS	MOUNTING <sup>2</sup>	FINISH <sup>4</sup>
KRSC - KRS Channel <sup>1</sup>	48 - 48" 72 - 72" 96 - 96" <sup>3</sup> 120 - 120" <sup>3</sup> 144 - 144" <sup>3</sup>	C - Clear F - Frosted HF - Half Frosted FF - Flat Frosted	HS - Hard Surface Mounting Bracket GS - Gypsum Surface Mounting Bracket	BASE SA - Silver Anodized  POWDER COATED BK - Black BZ - Bronze WH - White

1 - End Caps are included with channel, two of H3(no hole). Order additional End Caps as necessary.  
2 - Mounting Clips are included with channel. Refer to chart above for provided mounting clip quantities. Order additional Mounting Clips as necessary.

3 - For Channels and Lenses over 96", incremental shipping charges will apply.  
4 - Powder Coat finishes may have extended lead times. Custom RALs are available, please consult Inside Sales with specific request.

All Channels come with a specified set of Mounting Clips and End Caps, see Ordering Code for details. Order additional Mounting Clips and End Caps as necessary.

### Mounting Brackets

**MB-KRMSC-G**  
Stainless Steel Gypsum Surface Mounting Bracket  
**-GS**

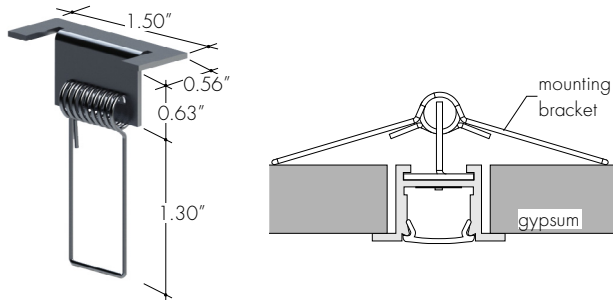

**MB-KRMSC-H**  
Stainless Steel Hard Surface Mounting Bracket  
**-HS**

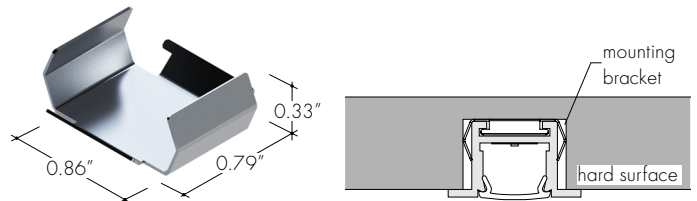

### End Caps

**EC-KRSC-F-H3-XX**  
Silver Anodized End Cap

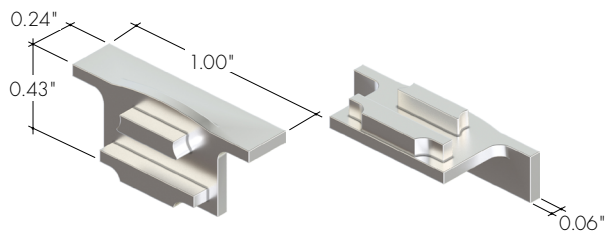

XX	Color
SA	Silver Anodized
WH	White
BK	Black
BZ	Bronze

