

USA Installation Instructions

Remote Controlled Spotlight Type DRX2

⚠ BEFORE YOU START

Read these instructions carefully. For the latest instructions on all our products see www.rclighting.com/downloads

🔧 These instructions cover the following installation methods:

- A 2-Circuit Installation
- B 4" Junction Box Installation
- C Accessory Change

⚠ IMPORTANT SAFETY INFORMATION CONSIGNES DE SÉCURITÉ IMPORTANTES

- A Read all instructions.
Lire toutes les instructions.
- B Do not install any part of a track system less than 5 feet above the floor.
N'installez aucune partie d'un système de voie à moins de 5 pieds du sol.
- C Do not install any luminaire assembly closer than 6 inches from any curtain, or similar combustible material.
N'installez aucun luminaire à moins de 6 pouces d'un rideau ou d'un matériau combustible similaire.

SAVE THESE INSTRUCTIONS CONSERVEZ CES INSTRUCTIONS

PRODUCT IS NOT SUITABLE FOR PHASE DIMMING

🔧 THIS PRODUCT MUST BE INSTALLED IN ACCORDANCE WITH THE APPLICABLE INSTALLATION

CODE BY A PERSON FAMILIAR WITH THE CONSTRUCTION AND OPERATION OF THE PRODUCT AND THE HAZARDS INVOLVED.

FOR USE WITH STUCCHI ONETRACK TRACK SYSTEM
À UTILISER AVEC STUCCHI ONETRACK TRACK SYSTEM

🔧 If using a track adaptor, ensure it is compatible with the track system installed. Failure to do so may result in danger of electric shock and damage to the product.

⚡ Ensure electrical rating shown on product label conforms to incoming voltage supply.

🚫 Do not modify the product in any way. RCL accepts no responsibility for damage caused by modifying this product.

IP20 Dry locations only.

⚠ Caution, product will become hot in use. Allow to cool before touching.

♻ Dispose of this product in accordance with WEEE or other national regulations.

A 2-Circuit Track Installation

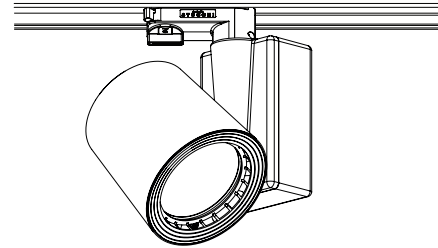

- 1 Ensure the track adaptor is compatible with the 2-Circuit track system installed. Unless otherwise specified, the DRX2 luminaire is supplied with a Onetrack 2-Circuit track adaptor as standard (120V 2-circuit track shown for reference).

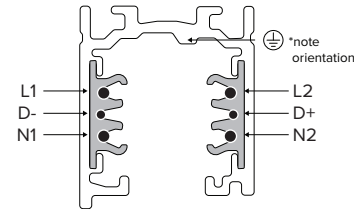

- 2 To mount the track adaptor into the track system, check that both tabs on the adaptor are in the open position and insert into the track.

Ensure the track adaptor is orientated correctly. Align the earthing tabs (A) with the slot (B) on the track.

🔧 NOTES

- Allow a mounting distance of 15 3/4" (~400mm Min) between each luminaire's centre of rotation.
- If suspending Onetrack, be sure conform with Eutrac's mechanical load guidelines detailed in their Installation Details document

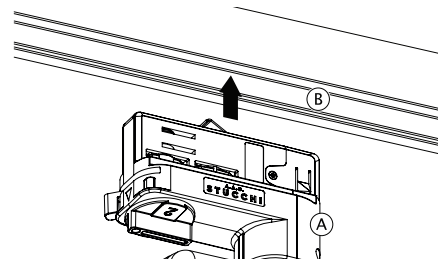

- 3 Rotate tab (C) clockwise 45° to connect the adaptor to the neutral circuit.

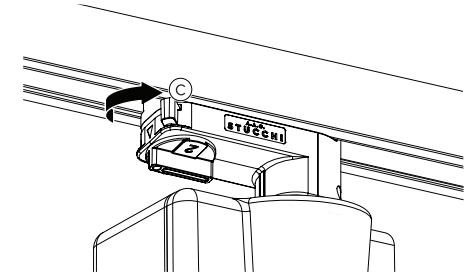

- 4 Rotate tab (D) to the desired circuit position (see section 5).

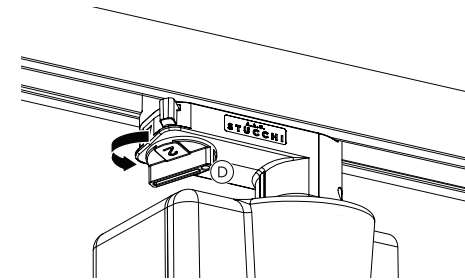

- 5 With the 2-Circuit track adaptor, you can choose which circuit the luminaire is connected to:

Unconnected - The luminaire is fixed to the track but not connected to any circuit.

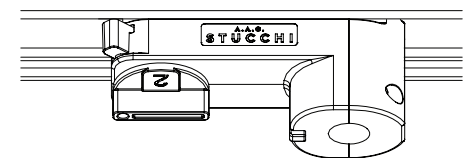

Circuit 2 - From the starting position, rotate the tab clockwise 90°.

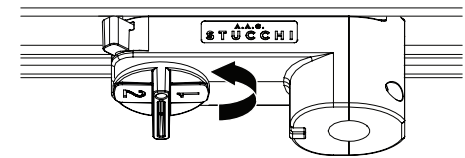

B 4" Junction Box Installation

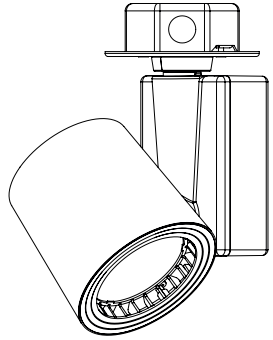

- 1 The junction box required for installation should not exceed 4" in diameter and requires 2x #8-32 UNC threaded mounting holes positioned 3 1/2" (89mm) apart from the centre of origin.

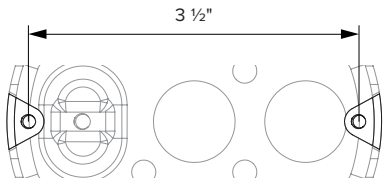

- 2 The junction box requires a minimum clearance distance of 8" (~200mm) above and around the mounting point and a ceiling material thickness of 3/32" - 1 1/2" (~3-35mm).

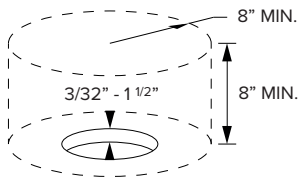

- 3 For multiple installations, ensure a minimum distance of 15 3/4" (~400mm) between mounting points.

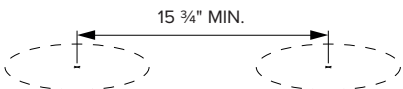

- 4 Mark up the ceiling and cut a circular hole between 4" - 4 1/2" (~Ø95-100mm) in diameter.

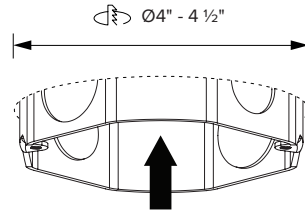

- 5 Insert the 4" junction box through the ceiling cutout and safely screw to a construction bracket using the appropriate screws.

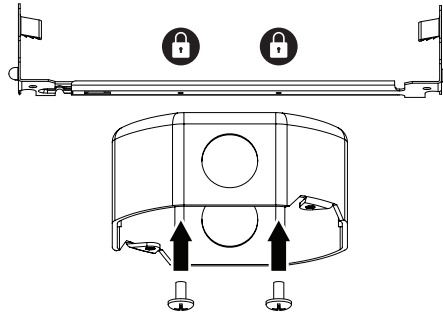

- 6 Examine your joist material. If the joist is wood, hammer in nail support (if applicable) and fix the construction bracket in position with wood screws or nails. If the joist is metal, use suitable screws.

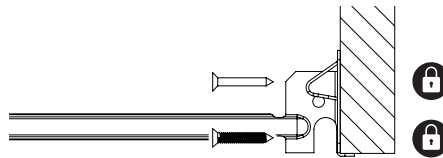

- 7 Run mains voltage cable through the installed junction box and connect to the luminaire using an electrical connector (not supplied).

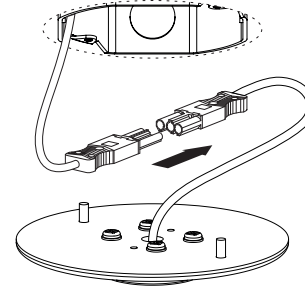

NOTES

- For further instructions on DMX wiring and installation, please refer to Section D or DOC-083.

- 8 With the luminaire safely wired inside the fully installed junction box, secure the luminaire to the underside of the enclosure using the 2x #8-32 screws provided.

Make sure that the underside of the DRX2 mounting plate is flush with the ceiling line.

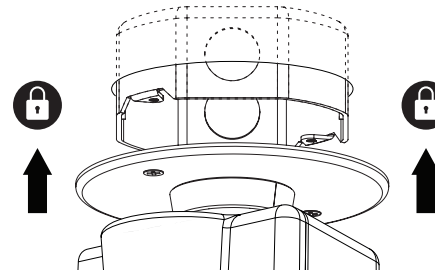

C Accessory Change

- 1 DRX2 accessories work in conjunction with the DRX2 Accessory Clip. To ensure that the accessory is safely held in place at all times, combine the accessory with the clip.

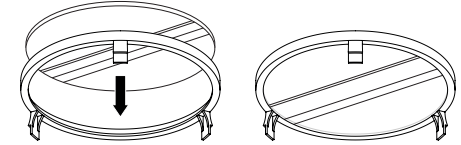

- 2 Using the finger grips on the outside of the clip, raise the accessory into the optic holder of the DRX2.

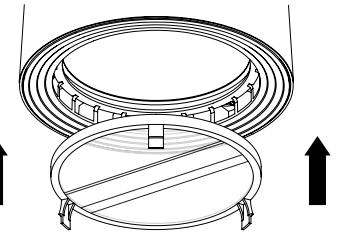

- 3 To fix the accessory clip safely in place, push it through the optic face until all 3 clips snap into place.

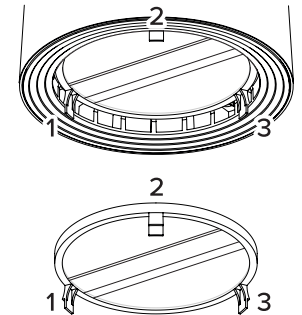



If you have any difficulty installing this product please contact:

Remote Controlled Lighting Ltd (UK) | 42 Riverside Road, London SW17 0BA
+44 (0) 20 8404 2400 | tech@rclighting.com

Remote Controlled Lighting Ltd (Asia) | Unit 13, 8/F, Lai Sun Yuen Long Centre
21-35 Wang Yip Street East, Yuen Long, Hong Kong
T: +852 2310 9733 | F: +852 2310 9723
asia_sales@rclighting.com