

Features

- 24VDC Class 2 fixtures made to order up to 144". Fixtures can be linked up to 40' depending on output
- Suitable for undercabinet, surface mount, and direct view applications
- Approved for closet/storage space installation per NEC 410.16(A) (3) and 410.16(C)(5) on outputs 5.7 W/ft or less
- Class 2 listed for damp locations
- Dot free even illumination with frosted lens
- Average Life (L70): 50,000hrs
- High Color Quality options offer premium quality and vibrant colors with R9 values up to 97
- High Efficacy options offer best in class output and efficacy with over 690 lm/ft and up to 77 lm/W
- Proprietary strong bond solder method handles up to 50 lbs of pull force on wire leads and connectors
- 7 Year warranty

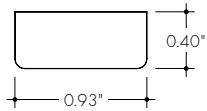

Finish Options (see page 3 for additional information)

Base	<input type="checkbox"/> Silver Anodized
Powder Coat	<input type="checkbox"/> Black <input type="checkbox"/> Bronze <input type="checkbox"/> White
Premium	<input type="checkbox"/> Matte Black <input type="checkbox"/> Warm Nickel <input type="checkbox"/> Aged Brass <input type="checkbox"/> Polished Gold <input type="checkbox"/> Chrome



Technical Information

MODEL	High Color Quality			High Efficacy	
	72SO	72HO	72VHO	HE64VHO	HE64XHO
OUTPUT OPTIONS					
Lumens Output (3000K) (with a Frosted Lens)	159 lm/ft	258 lm/ft	313 lm/ft	617 lm/ft	693 lm/ft
Average Power Consumption (for a 4' section)	2.8 W/ft	4.8 W/ft	6.0 W/ft	7.5 W/ft	9.6 W/ft
Efficacy	57 lm/W	54 lm/W	52 lm/W	82 lm/W	72 lm/W
Max Run Length (in series)	40 ft	31 ft	22 ft	15 ft	13 ft
Ambient Operating Temperature Range*	-5°F - 125°F (-20°C - 50°C)			-5°F - 115°F (-20°C - 45°C)	-5°F - 95°F (-20°C - 35°C)

*Ambient Operating Temperature Range to maintain L70 of 50k+ hours in normal mounting conditions for the fixture. Exceeding Ambient Operating Temperature Range may result in decreased life/output. Consult Technical Support for specific inquiries.

High Color Quality (72)

CCT	Multiplier (reference - 3000K)	TM-30		
		CRI	R _f	R _g R ₉
1900K	0.55	96	94	97 90
2200K	0.70	96	95	101 89
2400K	0.72	98	97	101 91
2700K	0.74	97	96	101 91
3000K	1.00	97	95	104 97
3500K	1.02	97	94	105 97
4100K	1.07	97	90	99 97

High Efficacy (HE64)

CCT	Multiplier (reference - 3000K)	TM-30		
		CRI	R _f	R _g R ₉
2200K	0.73	92	91	97 42
2500K	0.81	93	96	96 62
2700K	0.94	92	90	99 58
3000K	1.00	92	89	99 57
3500K	1.02	92	89	99 60
4000K	1.02	92	86	94 71

Ordering Code

MODEL	LENGTH ¹	OUTPUT ²	CCT	LENS	MOUNTING	FINISH ³	FEED POSITION LEFT ⁴	FEED POSITION RIGHT ⁴	ACCESSORIES ⁵
Bar-Bara	12" - 144" 1" increments	72SO-Standard 72HO-High 72VHO-Very High	19K-1900K 22K-2200K 24K-2400K 27K-2700K 30K-3000K 35K-3500K 41K-4100K	F-Frosted N-Narrow Beam M-Medium BW-Batwing AS-Asymmetric ⁵	FC-Fixed Clip MAG-Magnetic ⁶	BASE SA-Silver Anodized POWDER COAT BK-Black ⁷ BZ-Bronze WH-White ⁷ PREMIUM MBK-Matte Black WN-Warm Nickel AB-Aged Brass PG-Polished Gold ⁸ CH-Chrome ⁸	WIRE LEADS (72") LWE-Wire End Feed LWB-Wire Back Feed LNPF-No Power Feed QUICK CONNECTS (4") LFE-Female Q/C, End Feed LFB-Female Q/C, Back Feed LNPF-No Power Feed	WIRE LEADS (72") RWE-Wire End Feed RWB-Wire Back Feed RNPF-No Power Feed QUICK CONNECTS (4") RFE-Female Q/C, End Feed RFB-Female Q/C, Back Feed RNPF-No Power Feed	---N/A, leave blank BLS-Blade louver, Silver BLBK-Blade louver, Black BLWH-Blade louver, White GSS-Glare shield, Silver GSBK-Glare shield, Black GSWH-Glare shield, White
	12" - 144" 2" increments	HE64VHO-Very High HE64XHO-Max	22K-2200K 25K-2500K 27K-2700K 30K-3000K 35K-3500K 40K-4000K						

1 - Custom lengths and increments are available, please consult Inside Sales with specific request.
 2 - All High Efficacy options can be used to comply with Title 24 JAB. High Color Quality options can be used to comply with Title 24 JAB depending on Output, CCT, and Lens selections. See multiplier charts to calculate specific efficacies.
 3 - Non Base finishes may have extended lead times. Custom RALs are available, please consult Inside Sales with specific request.
 4 - LNPF - RNPF is not a valid configuration option
 5 - Louver Accessories are not compatible with Asymmetric lens.
 6 - Magnetic mounting option is not compatible with the louvers.
 7 - Black or White finish must be selected when ordering a louver or glare shield. See lens options on page 3.
 8 - Polished Gold finishes and Chrome finishes have a maximum fixture length of 96".

Powerfeeds and Connectors

Power Feed Position Options and Orientation

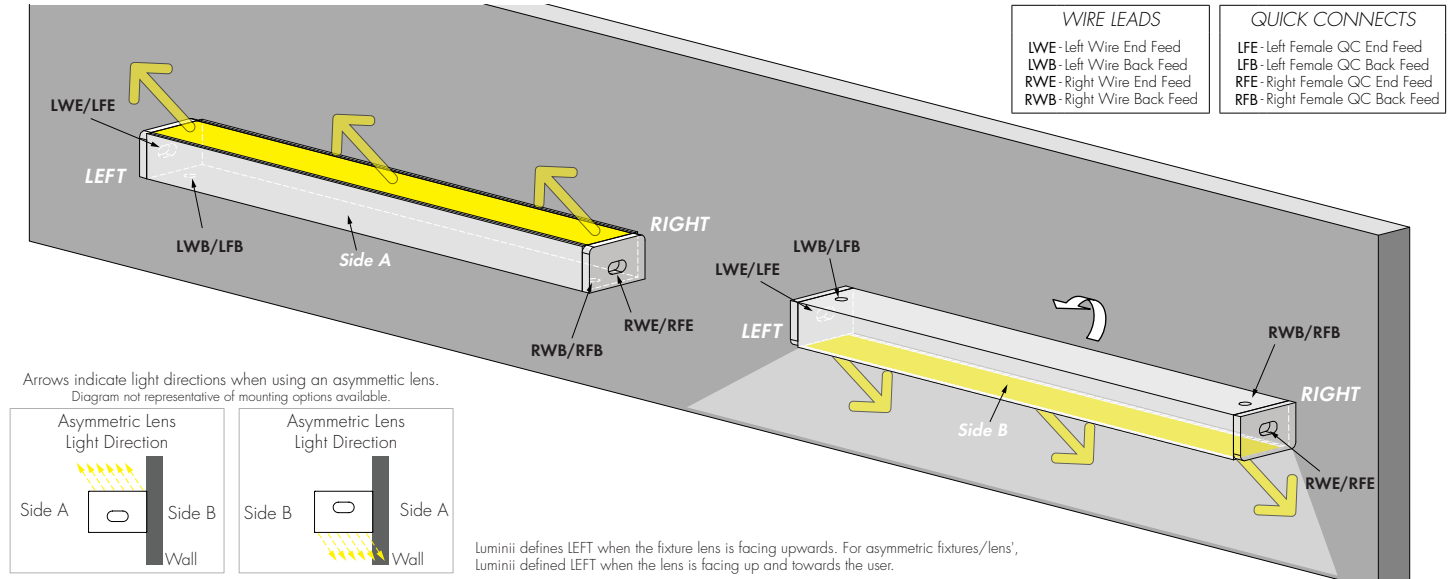

Powerfeeds and Connectors

Linking and Extension Cable Options

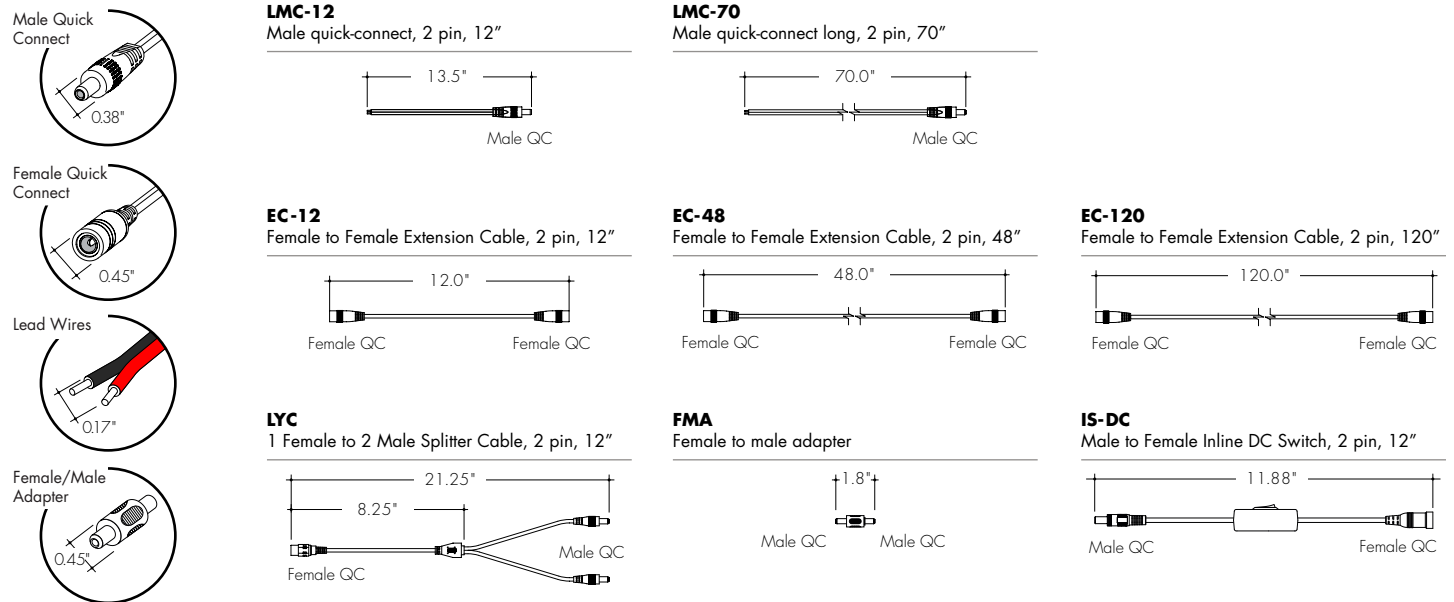

Sample Layout

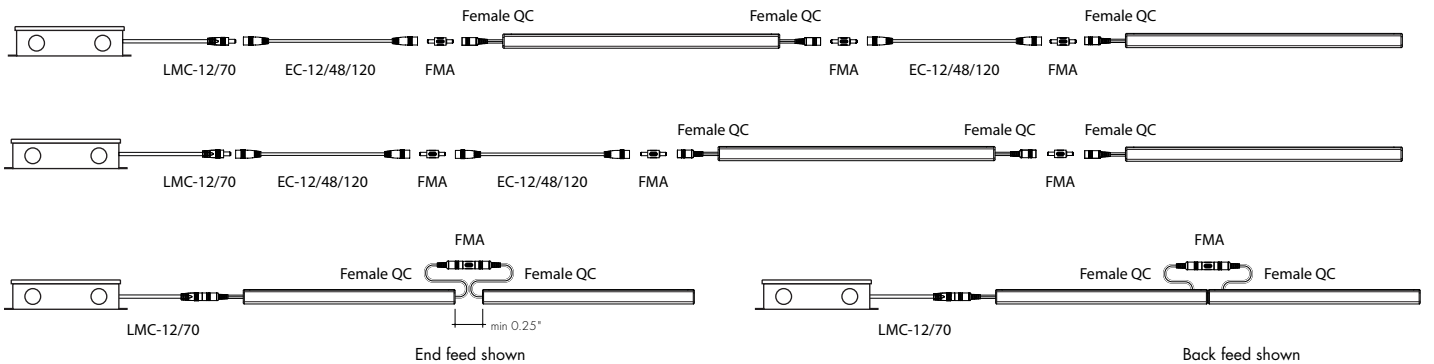

Product Dimensions

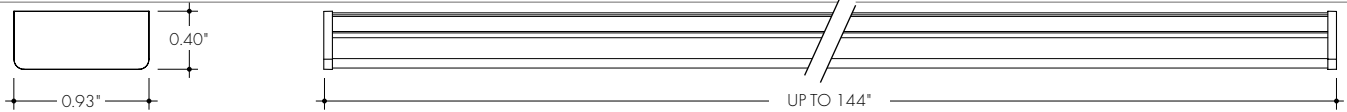

Mounting Clip Details

FC
Fixed Clip

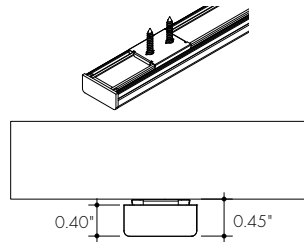

MAG
Magnetic Clip

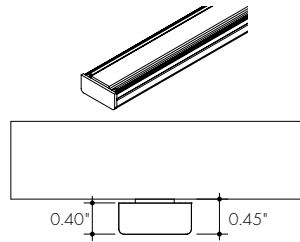

Lens Options

F
Frosted Lens

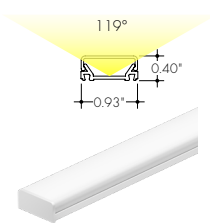

N
Narrow Beam Lens

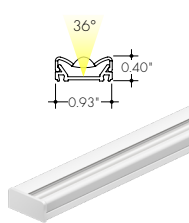

M
Medium Lens

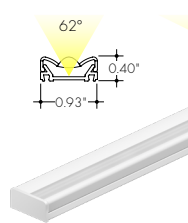

BW
Batwing Lens

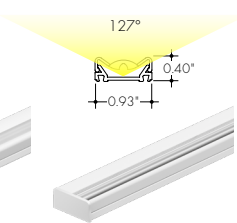

AS
Asymmetric Lens

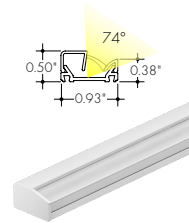

BLXX
Blade Louver (frosted lens shown)

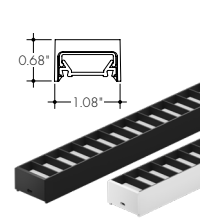

GSXX
Glare Shield (frosted lens shown)

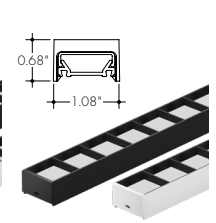

XX	Color
BK	All Black
WB	White Exterior, Black Interior

Finish Options

- Finish options are available in a wide variety, allowing for complete customization of style and aesthetic.
- Non Base finishes may have extended lead times.
- Polished Gold and Chrome finishes have a maximum fixture length of 96".
- Custom RALs are available, please consult Inside Sales with specific request.
- Narrow, Medium, Batwing, and Asymmetric lens offerings will always come with a white finish on the front reflector.

Silver Anodized Base



Silver Anodized is a soft silver with a clear finish.

Black Powder Coat



Black is a true deep black with a glossy finish.

Bronze Powder Coat

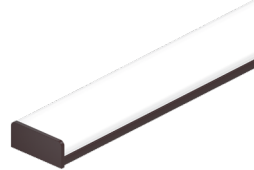

Bronze is a rich, dark brown with a satin finish.

White Powder Coat



White is a polar bright white and field paintable.

Matte Black Premium



Matte Black is a dark, pitch-black with a soft flat finish.

Warm Nickel Premium



Warm Nickel is a soft, silvery smoke with warm tones and a satin finish.

Aged Brass Premium



Aged Brass is a deep brown shade with slightly golden undertones.

Polished Gold Premium

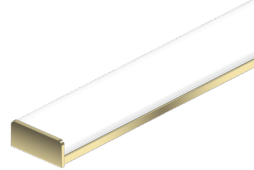

Polished Gold is bright and radiant for a brilliant finish.

Chrome Premium



Chrome is a highly reflective silver polish.

Black with Narrow Beam

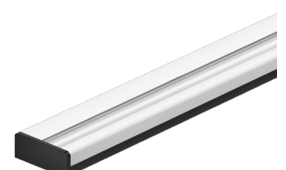

NOTE: Either a white finish or louver/glare shield is recommended with these lens options.

Light Transmission and Dotting

Lens/Accessory

Output Options	Batwing Lens				Narrow Beam Lens				Frosted Lens				Medium Lens				Asymmetric Lens			
	100%	50%	10%	1%	100%	50%	10%	1%	100%	50%	10%	1%	100%	50%	10%	1%	100%	50%	10%	1%
72SO	CD	CD	CD	CD	CD	CD	CD	CD	ND	ND	ND	ND	CD	CD	CD	CD	CD	CD	CD	CD
72HO	CD	CD	CD	CD	CD	CD	CD	CD	ND	ND	ND	ND	CD	CD	CD	CD	CD	CD	CD	CD
72VHO	CD	CD	CD	CD	CD	CD	CD	CD	ND	ND	ND	ND	CD	CD	CD	CD	CD	CD	CD	CD
HE64VHO	CD	CD	CD	CD	CD	CD	CD	CD	ND	ND	ND	ND	CD	CD	CD	CD	CD	CD	CD	CD
HE64XHO	CD	CD	CD	CD	CD	CD	CD	CD	ND	ND	ND	ND	CD	CD	CD	CD	CD	CD	CD	CD
Transmission Percentage	110%				107%				100%				97%				84%			
Transmission Percentage With Blade Louver	46%				53%				39%				46%				Not Compatible			
Transmission Percentage With Glare Shield	64%				73%				54%				66%				Not Compatible			

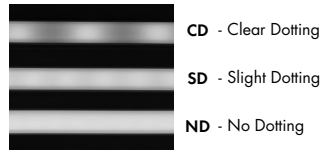

Accessory Options

LV-BL-BARC-24-XX

Blade Louver reduces glare at high angle in two directions. Also available with complete fixture, use ordering code **-BLXX**

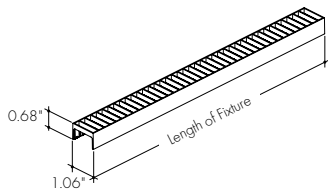

LV-GS-BARC-24-XX

Glare Shield reduces glare at high angle, field cuttable. Also available with complete fixture, use ordering code **-GSXX**

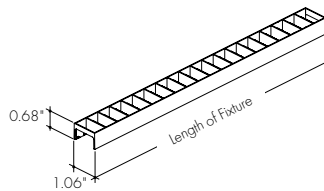

XX	Color
BK	All Black
WB	White Exterior, Black Interior

LVSP-4T-BK

Low Voltage, 4 Terminal Splice Box, Black

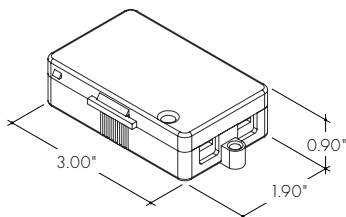

OS-DC-F4-BK

Occupancy Sensor

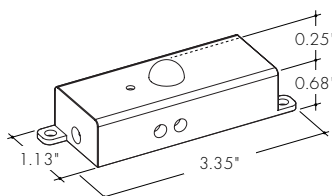

Male Quick Connect, FMA, LMC, LYC, or IS-DC are required for input and output.

DIM-DC-F4-BK

24VDC Low Voltage In-line Dimmer Module

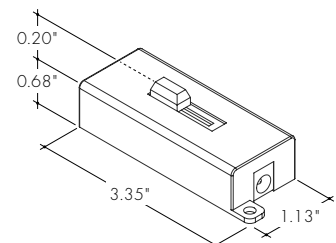

Male Quick Connect, FMA, LMC, LYC, or IS-DC are required for input and output.

Photometry

BAR-48-72VHO-30K-F

Bara, 4ft, 3000K, VHO, Frosted Lens

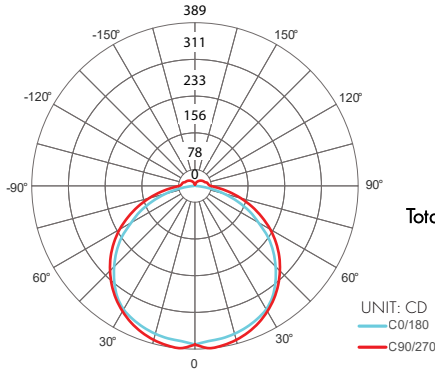

Zonal lumen Summary 3000K

Zone	Lumen	% Fixture	
0-30	301	24.0%	
0-40	501	39.9%	
0-60	906	72.3%	
0-90	1185	94.6%	
Total	0-180	1254	100%

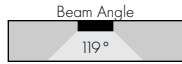

BAR-48-72VHO-30K-N

Bara, 4ft, 3000K, VHO, Narrow Beam

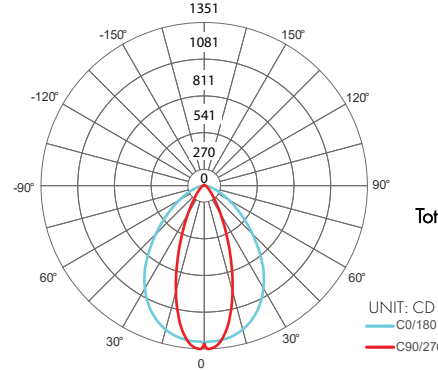

Zonal lumen Summary 3000K

Zone	Lumen	% Fixture	
0-30	686	51.0%	
0-40	935	69.6%	
0-60	1225	91.1%	
0-90	1331	99.0%	
Total	0-180	1344	100%

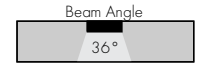

BAR-48-72VHO-30K-M

Bara, 4ft, 3000K, VHO, Medium Lens

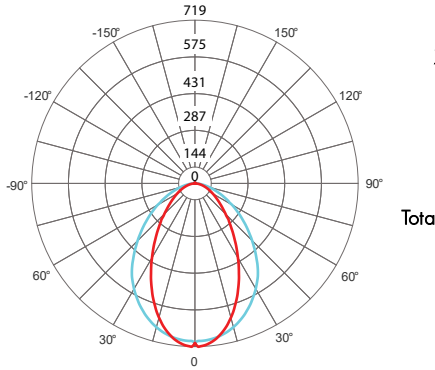

Zonal lumen Summary 3000K

Zone	Lumen	% Fixture	
0-30	451	37.1%	
0-40	682	56.1%	
0-60	1033	85.1%	
0-90	1202	99.0%	
Total	0-180	1214	100%

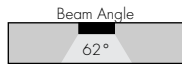

BAR-48-72VHO-30K-BW

Bara, 4ft, 3000K, VHO, Batwing Lens

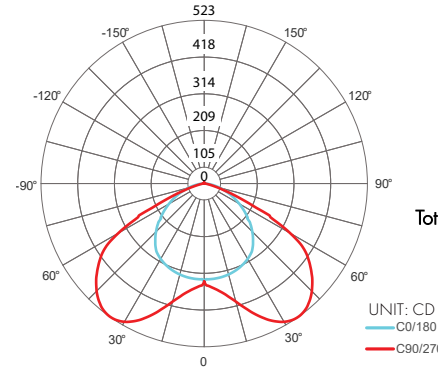

Zonal lumen Summary 3000K

Zone	Lumen	% Fixture	
0-30	285	20.7%	
0-40	518	37.6%	
0-60	1063	77.1%	
0-90	1364	99.0%	
Total	0-180	1378	100%

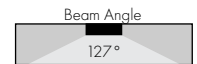

BAR-48-72VHO-30K-AS

Bara, 4ft, 3000K, VHO, Asymmetric Lens

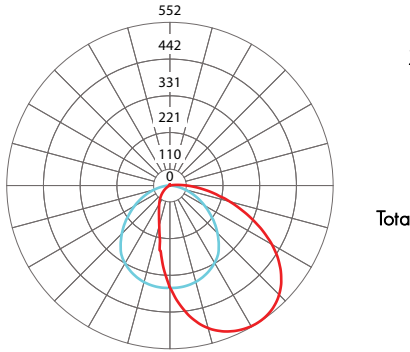

Zonal lumen Summary 3000K

Zone	Lumen	% Fixture	
0-30	247	23.3%	
0-40	413	39.1%	
0-60	769	72.8%	
0-90	1039	98.3%	
Total	0-180	1057	100%

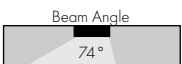

Photometry Charts

	OUTPUT OPTIONS	LIGHT LOSS FACTOR
High Color Quality	72SO	51%
	72HO	82%
	72VHO (Tested data shown)	100%
High Efficacy	HE64VHO	197%
	HE64XHO	221%

Power Consumption

Tested at Full Power with PS-UNI Series power supplies.

*For Back Feed add 4/16" (1/4") to Actual Length. Standard Nominal Lengths offered provide minimal shadowing. For alternate lengths, please consult Inside Sales with specific request.

High Color Quality (72)

Nominal Length (in)	End Feed Actual Length*	Watts			Nominal Length (in)	End Feed Actual Length*	Watts			Nominal Length (in)	End Feed Actual Length*	Watts			Nominal Length (in)	End Feed Actual Length*	Watts		
		SO	HO	VHO			SO	HO	VHO			SO	HO	VHO			SO	HO	VHO
12	11 1/16	2.7	4.4	6.2	47	46 15/16	10.5	17.4	23.1	82	81 11/16	18.3	29.5	38.4	117	116 7/16	25.9	40.8	52.4
13	12 4/16	2.7	4.4	6.2	48	-	-	-	-	83	82 14/16	18.5	29.8	38.8	118	117 9/16	26.1	41.1	52.8
14	13 6/16	2.9	4.8	6.7	49	48 2/16	10.7	17.8	23.5	84	-	-	-	-	119	118 12/16	26.3	41.4	53.2
15	14 9/16	3.1	5.2	7.3	50	49 4/16	11.1	18.6	24.4	85	84	18.7	30.1	39.2	120	119 15/16	26.5	41.7	53.6
16	15 11/16	3.4	5.6	7.8	51	50 7/16	11.4	18.9	24.9	86	85 3/16	19.2	30.8	40.0	121	-	-	-	-
17	16 14/16	3.6	6.0	8.3	52	51 9/16	11.6	19.3	25.3	87	86 5/16	19.4	31.1	40.4	122	121 1/16	26.7	42.0	54.0
18	-	-	-	-	53	52 12/16	11.9	19.7	25.7	88	87 8/16	19.6	31.5	40.8	123	122 4/16	27.1	42.6	54.7
19	18	3.9	6.5	8.9	54	53 14/16	12.1	20.1	26.1	89	88 10/16	19.9	31.8	41.1	124	123 6/16	27.3	42.9	55.0
20	19 3/16	4.4	7.3	9.9	55	-	-	-	-	90	89 13/16	20.1	32.2	41.5	125	124 9/16	27.5	43.1	55.4
21	20 5/16	4.6	7.7	10.5	56	55 1/16	12.3	20.5	26.6	91	90 15/16	20.4	32.5	41.9	126	125 11/16	27.7	43.4	55.7
22	21 8/16	4.8	8.1	11.0	57	56 4/16	12.8	21.3	27.4	92	-	-	-	-	127	126 14/16	27.9	43.7	56.1
23	22 10/16	5.1	8.6	11.5	58	57 6/16	13.1	21.6	27.8	93	92 2/16	20.6	32.9	42.3	128	-	-	-	-
24	23 13/16	5.3	9.0	12.1	59	58 9/16	13.3	22.0	28.3	94	93 4/16	21.1	33.6	43.1	129	128	28.1	43.9	56.4
25	24 15/16	5.6	9.4	12.6	60	59 11/16	13.6	22.4	28.7	95	94 7/16	21.3	33.9	43.4	130	129 3/16	28.5	44.5	57.1
26	-	-	-	-	61	60 14/16	13.8	22.8	29.1	96	95 9/16	21.5	34.2	43.8	131	130 5/16	28.7	44.7	57.4
27	26 2/16	5.8	9.8	13.1	62	-	-	-	-	97	96 12/16	21.8	34.6	44.2	132	131 8/16	28.9	45.0	57.8
28	27 4/16	6.2	10.5	14.1	63	62	14.0	23.1	29.6	98	97 15/16	22.0	34.9	44.6	133	132 10/16	29.1	45.3	58.1
29	28 7/16	6.5	10.9	14.5	64	63 3/16	14.5	23.8	30.5	99	-	-	-	-	134	133 13/16	29.3	45.5	58.4
30	29 9/16	6.7	11.2	15.0	65	64 5/16	14.7	24.1	31.0	100	99 1/16	22.2	35.2	45.0	135	134 15/16	29.5	45.7	58.7
31	30 12/16	6.9	11.6	15.5	66	65 8/16	14.9	24.4	31.4	101	100 4/16	22.5	35.9	45.9	136	-	-	-	-
32	31 14/16	7.1	12.0	16.0	67	66 10/16	15.1	24.7	31.9	102	101 6/16	22.7	36.2	46.3	137	136 2/16	29.6	45.9	59.1
33	-	-	-	-	68	67 13/16	15.3	25.0	32.4	103	102 9/16	22.9	36.5	46.7	138	137 4/16	30.0	46.3	59.7
34	33 1/16	7.3	12.3	16.5	69	68 15/16	15.5	25.4	32.8	104	103 11/16	23.1	36.8	47.1	139	138 7/16	30.2	46.5	60.0
35	34 4/16	7.8	13.1	17.4	70	-	-	-	-	105	104 14/16	23.3	37.1	47.5	140	139 9/16	30.3	46.8	60.3
36	35 6/16	8.0	13.4	17.9	71	70 2/16	15.8	25.7	33.3	106	-	-	-	-	141	140 12/16	30.5	47.0	60.6
37	36 9/16	8.2	13.8	18.4	72	71 4/16	16.2	26.3	34.2	107	106	23.5	37.4	48.0	142	141 15/16	30.7	47.2	61.0
38	37 11/16	8.4	14.2	18.9	73	72 7/16	16.4	26.6	34.7	108	107 3/16	23.9	38.1	48.8	143	-	-	-	-
39	38 14/16	8.7	14.5	19.3	74	73 9/16	16.6	26.9	35.1	109	108 5/16	24.1	38.4	49.2	144	143 1/16	30.8	47.4	61.3
40	-	-	-	-	75	74 12/16	16.8	27.3	35.5	110	109 8/16	24.3	38.7	49.6					
41	40	8.9	14.9	19.8	76	75 14/16	17.1	27.6	35.9	111	110 10/16	24.5	39.0	50.0					
42	41 3/16	9.3	15.6	20.7	77	-	-	-	-	112	111 13/16	24.8	39.3	50.4					
43	42 5/16	9.6	16.0	21.2	78	77 1/16	17.3	27.9	36.3	113	112 15/16	25.0	39.6	50.8					
44	43 8/16	9.8	16.4	21.7	79	78 4/16	17.7	28.5	37.2	114	-	-	-	-					
45	44 10/16	10.0	16.7	22.1	80	79 6/16	17.9	28.9	37.6	115	114 2/16	25.2	39.9	51.2					
46	45 13/16	10.2	17.1	22.6	81	80 9/16	18.1	29.2	38.0	116	115 4/16	25.6	40.5	52.0					

Power Consumption

Tested at Full Power with PS-UNI Series power supplies.

*For Back Feed add 4/16" (1/4") to Actual Length. Standard Nominal Lengths offered provide minimal shadowing. For alternate lengths, please consult Inside Sales with specific request.

High Efficacy (HE64)

Nominal Length (in)	End Feed Actual Length*	Watts		Nominal Length (in)	End Feed Actual Length*	Watts		Nominal Length (in)	End Feed Actual Length*	Watts		Nominal Length (in)	End Feed Actual Length*	Watts	
		VHO	XHO			VHO	XHO			VHO	XHO			VHO	XHO
12	11 4/16	7.6	9.7	47	46 1/16	28.2	35.9	82	-	-	-	117	-	-	-
13	12 12/16	7.6	9.7	48	47 9/16	29.5	37.6	83	82 7/16	51.7	63.4	118	117 4/16	72.8	80.7
14	-	-	-	49	-	-	-	84	83 15/16	52.3	63.8	119	118 12/16	73.3	81.0
15	14 4/16	8.9	11.3	50	49 2/16	30.1	38.4	85	-	-	-	120	-	-	-
16	15 13/16	9.5	12.1	51	50 10/16	31.4	40.2	86	85 7/16	53.6	64.7	121	120 4/16	74.4	81.7
17	-	-	-	52	-	-	-	87	86 15/16	54.2	65.3	122	121 12/16	74.8	82.0
18	17 5/16	10.7	13.6	53	52 2/16	32.0	41.1	88	-	-	-	123	-	-	-
19	18 13/16	11.4	14.4	54	53 10/16	33.3	42.9	89	88 7/16	55.5	66.3	124	123 5/16	75.6	82.5
20	-	-	-	55	-	-	-	90	90	56.2	66.8	125	124 13/16	76.0	82.8
21	20 5/16	12.6	16.0	56	55 2/16	34.0	43.8	91	-	-	-	126	-	-	-
22	21 13/16	13.2	16.8	57	56 11/16	35.2	45.5	92	91 8/16	57.5	67.9	127	126 5/16	76.8	83.4
23	-	-	-	58	-	-	-	93	-	-	-	128	127 13/16	77.2	83.6
24	23 6/16	14.5	18.3	59	58 3/16	36.5	47.3	94	93	58.2	68.4	129	-	-	-
25	24 14/16	15.1	19.1	60	59 11/16	37.2	48.2	95	94 8/16	59.5	69.5	130	129 6/16	78.0	84.2
26	-	-	-	61	-	-	-	96	-	-	-	131	130 14/16	78.4	84.5
27	26 6/16	16.4	20.7	62	61 3/16	38.4	50.0	97	96 1/16	60.1	70.0	132	-	-	-
28	27 14/16	17.0	21.4	63	62 12/16	39.1	50.8	98	97 9/16	61.4	71.1	133	132 6/16	79.2	85.0
29	-	-	-	64	-	-	-	99	-	-	-	134	133 14/16	79.6	85.4
30	29 7/16	18.2	23.0	65	64 4/16	40.4	52.5	100	99 1/16	62.0	71.7	135	-	-	-
31	30 15/16	18.9	23.8	66	65 12/16	41.0	53.4	101	100 9/16	63.2	72.9	136	135 7/16	80.3	86.2
32	-	-	-	67	-	-	-	102	-	-	-	137	136 15/16	80.6	86.6
33	32 7/16	20.1	25.3	68	67 4/16	42.3	55.1	103	102 1/16	63.8	73.5	138	-	-	-
34	33 15/16	20.7	26.1	69	68 12/16	42.9	55.9	104	103 10/16	65.0	74.7	139	138 7/16	81.3	87.5
35	-	-	-	70	-	-	-	105	-	-	-	140	139 15/16	81.7	87.9
36	35 7/16	22.0	27.6	71	70 5/16	44.2	57.6	106	105 2/16	65.6	75.3	141	-	-	-
37	37	22.6	28.4	72	71 13/16	44.9	58.5	107	106 10/16	66.8	76.5	142	141 7/16	82.4	88.7
38	-	-	-	73	-	-	-	108	-	-	-	143	143	82.7	89.1
39	38 8/16	23.9	30.1	74	73 5/16	46.1	59.7	109	108 2/16	67.4	77.1	144	-	-	-
40	-	-	-	75	74 13/16	46.7	60.1	110	109 11/16	68.5	78.0				
41	40	24.5	30.9	76	-	-	-	111	-	-	-				
42	41 8/16	25.7	32.6	77	76 6/16	48.0	60.9	112	111 3/16	69.6	78.7				
43	-	-	-	78	77 14/16	48.6	61.3	113	112 11/16	70.1	79.0				
44	43 1/16	26.4	33.4	79	-	-	-	114	-	-	-				
45	44 9/16	27.6	35.1	80	79 6/16	49.8	62.2	115	114 3/16	71.2	79.7				
46	-	-	-	81	80 14/16	50.4	62.6	116	115 12/16	71.7	80.0				

Voltage Drop Calculator

The below chart assumes nominal voltage of 24 Volts and a Voltage Drop Allowance of 3% through the wire

Wattage [W]	Maximum Wire Length From Power Supply to Start of Run [ft]						
	12 AWG	14 AWG	16 AWG	18 AWG	20 AWG	22 AWG	24 AWG
5	1088.2	684.4	430.3	270.6	170.2	107.1	67.3
10	544.1	342.2	215.1	135.3	85.1	53.5	33.7
15	362.7	228.1	143.4	90.2	56.7	35.7	22.4
20	272.0	171.1	107.6	67.7	42.6	26.8	16.8
25	217.6	136.9	86.1	54.1	34.0	21.4	13.5
30	181.4	114.1	71.7	45.1	28.4	17.8	11.2
35	155.5	97.8	61.5	38.7	24.3	15.3	9.6
40	136.0	85.5	53.8	33.8	21.3	13.4	8.4
45	120.9	76.0	47.8	30.1	18.9	11.9	7.5
50	108.8	68.4	43.0	27.1	17.0	10.7	6.7
55	98.9	62.2	39.1	24.6	15.5	9.7	6.1
60	90.7	57.0	35.9	22.6	14.2	8.9	5.6
65	83.7	52.6	33.1	20.8	13.1	8.2	5.2
70	77.7	48.9	30.7	19.3	12.2	7.6	4.8
75	72.5	45.6	28.7	18.0	11.3	7.1	4.5
80	68.0	42.8	26.9	16.9	10.6	6.7	4.2
85	64.0	40.3	25.3	15.9	10.0	6.3	4.0
90	60.5	38.0	23.9	15.0	9.5	5.9	3.7
96	56.7	35.6	22.4	14.1	8.9	5.6	3.5

Power Supplies

See Power Supply instructions and spec sheet for wiring information. For a complete list of compatible dimmers, see Compatible Dimming Chart on the Resources page.

Ordering Code Universal Dimming Power Supplies 1% 120VAC - 277VAC

MODEL	INPUT CONTROL	ENVIRONMENT	WATTAGE	OUTPUT
PS-Power Supply, 120-277VAC	UNI-0-10V Dimming, Phase Dimming	D-Dry W-Wet	30-30 Watts 60-60 Watts 96-96 Watts 3x96-3x96 Watts	24-24 VDC

Compatibility: View a complete list of compatible dimmers on product page [\(Link\)](#)

0-10V - 1% dimming
MLV/ELV/TRIAC - 1% dimming, consult dimming compatibility chart

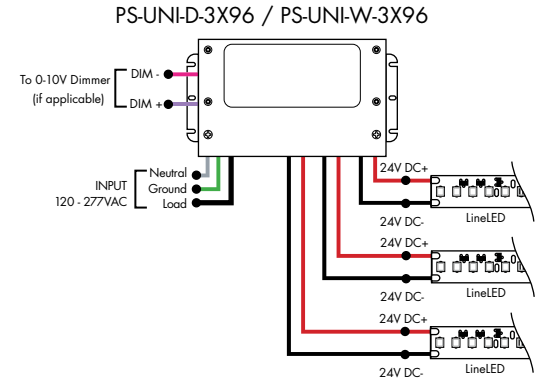
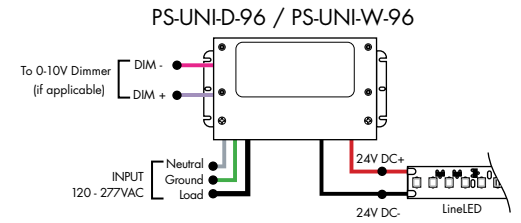

MODELS	PS-UNI-W-30W	PS-UNI-W-60W	PS-UNI-W-96W	PS-UNI-W-3X96W
Length	6.50"	7.40"	8.66"	11.85"
Width	3.73"	3.73"	3.73"	4.32"
Depth	1.61"	1.61"	1.61"	1.81"

MODELS	PS-UNI-D-30W	PS-UNI-D-60W	PS-UNI-D-96W	PS-UNI-D-3X96W
Length	8.77"	8.77"	8.11"	9.94"
Width	4.27"	4.27"	5.60"	7.61"
Depth	1.83"	1.83"	1.83"	2.02"

Ordering Code 0-10V Dimming Power Supplies 0.1% 120VAC - 277VAC

MODEL	INPUT CONTROL	ENVIRONMENT	WATTAGE	OUTPUT
PS-Power Supply, 120-277VAC	010V-LIN-0-10V Dimming (0.1%), Linear 010V-LOG-0-10V Dimming (0.1%), Logarithmic	D-Dry	96-96 Watts 3X96-3x96 Watts	24-24 VDC

MODELS	96W	3X96
Length	14.40"	15.00"
Width	5.20"	6.62"
Depth	2.60"	4.45"

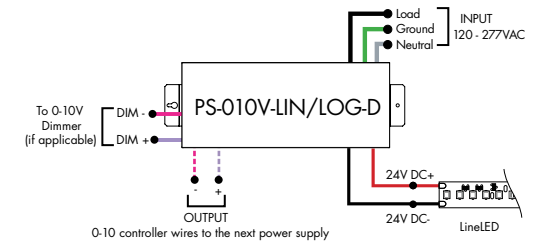
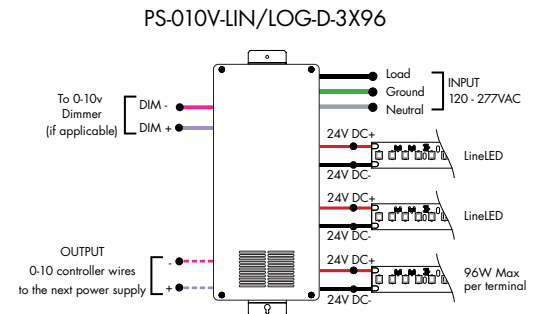

Athena 0-10V LED Driver

MODEL	INPUT CONTROL	ENVIRONMENT	WATTAGE	OUTPUT	FEATURE
PS-Power Supply, 120-277VAC	010V-LIN-0-10V Dimming, Linear 010V-LOG-0-10V Dimming, Logarithmic	D-Dry	96-96 W	24-24 VDC	AWNR-Athena

MODELS	96W
Length	14.40"
Width	5.20"
Depth	2.60"

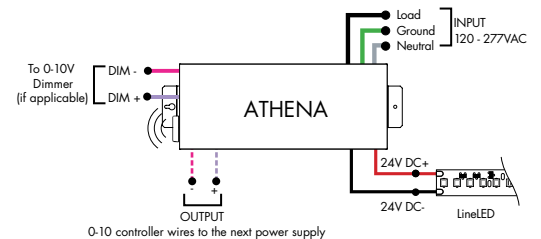

Power Supplies

See Power Supply instructions and spec sheet for wiring information. For a complete list of compatible dimmers, see Compatible Dimming Chart on the Resources page.

Ordering Code DALI Dimming Power Supplies 0.1% 120VAC - 277VAC

MODEL	INPUT CONTROL	ENVIRONMENT	WATTAGE	OUTPUT
PS-Power Supply, 120-277VAC	DALI-DALI (0.1%)	D-Dry	96-96 Watts 3X96-3X96 Watts	24-24 VDC

Model	96W	3X96
Length	14.40"	15.00"
Width	5.20"	6.62"
Depth	2.60"	4.56"

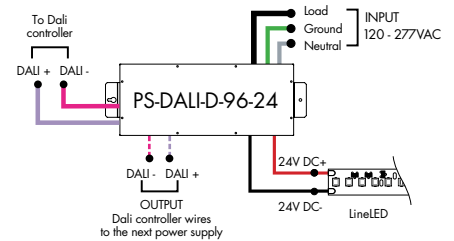
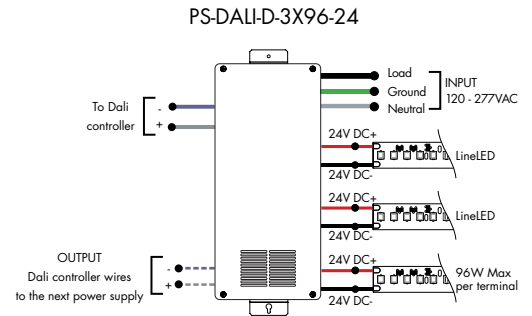

Ordering Code DMX Dimming Power Supplies 0.1% 120VAC - 277VAC Requires Zonal Control

MODEL	INPUT CONTROL	ENVIRONMENT	WATTAGE	OUTPUT
PS-Power Supply, 120-277VAC	DMX-DMX (0.1%)	D-Dry	96-96 Watts 3X96-3X96 Watts	24-24 VDC

*Zonal control power supplies. Control multiple tapes/zones using DMX channels.

MODELS	96W	3X96
Length	14.40"	15.00"
Width	5.20"	6.62"
Depth	2.60"	4.56"

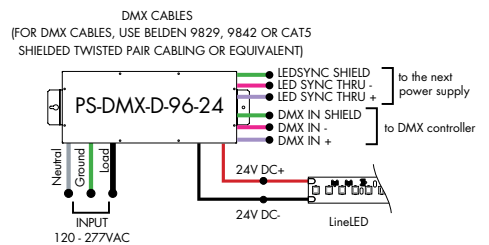
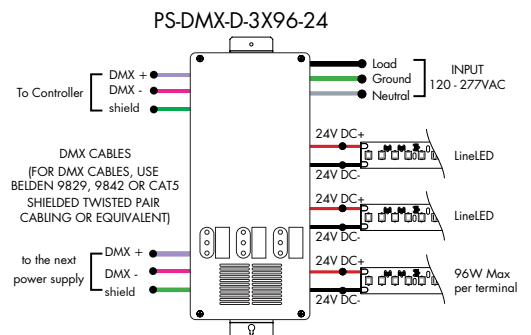

Ordering Code Enlightened Enabled Dimming Power Supplies 1% 120VAC - 277VAC

MODEL	INPUT CONTROL	ENVIRONMENT	WATTAGE	OUTPUT	FEATURE
PS-Power Supply, 120-277VAC	010V-0-10V Dimming (1%)	D-Dry	96-96 Watts	24-24 VDC	ENL-0-10V Enlightened

Model	96W
Length	14.40"
Width	5.20"
Depth	2.60"

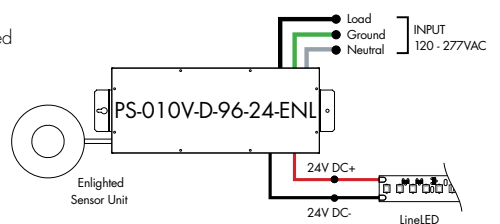

Power Supplies

See Power Supply instructions and spec sheet for wiring information. For a complete list of compatible dimmers, see Compatible Dimming Chart on the Resources page.

Ordering Code Non-Dimming Power Supply 120VAC - 277VAC

MODEL	INPUT CONTROL	ENVIRONMENT	WATTAGE	OUTPUT
PS - Power Supply, 120-277VAC	ND - Non Dimming	D - Dry	96-96 Watts	24 - 24 VDC

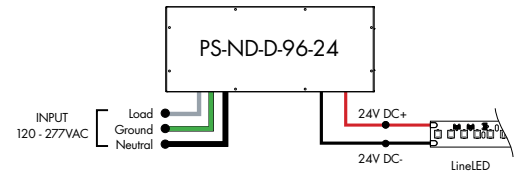

MODELS	96W
Length	14.40"
Width	5.20"
Depth	2.60"

Ordering Code Phase Dimming Power Supply 1% 120VAC - 277VAC

MODEL	INPUT CONTROL	ENVIRONMENT	WATTAGE	OUTPUT	OUTPUT CONTROL
PS - Power Supply, 120-277VAC	PH - Phase Dimming (Triac, ELV, MLV)	D - Dry	96 - 96 Watts	24 - 24 VDC	DC - Direct Current

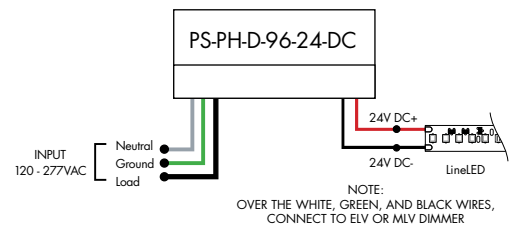

MLV/ELV/TRIAC - 1% dimming, consult dimming compatibility chart ([link](#))

MODELS	96W
Length	8.25"
Width	4.10"
Depth	1.56"

Ordering Code In-Ground Power Supplies

MODEL	INPUT CONTROL	ENVIRONMENT	WATTAGE	OUTPUT
PS120 - Power Supply, 120VAC PS240 - Power Supply, 240VAC PS277 - Power Supply, 277VAC	ELV - ELV Dimming (1%)	IG - In Ground	2X96 - 2X96 Watts	24 - 24 VDC

MODELS	2X96W
Length	8.40"
Width	8.30"
Depth	8.10"

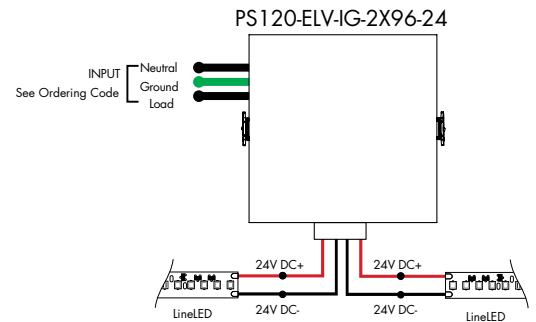

Power Supplies

See Power Supply instructions and spec sheet for wiring information. For a complete list of compatible dimmers, see Compatible Dimming Chart on the Resources page.



Luminii is a Lutron OEM Advantage Partner

Lutron Power Supplies 1%

MODEL

L3DA4U1UKL-CV240

HiLume™ 1% EcoSystem Voltage LED driver
40W max

MODELS	L3DA4U1UKL-CV240
Length	4.98"
Width	4.00"
Depth	2.62"

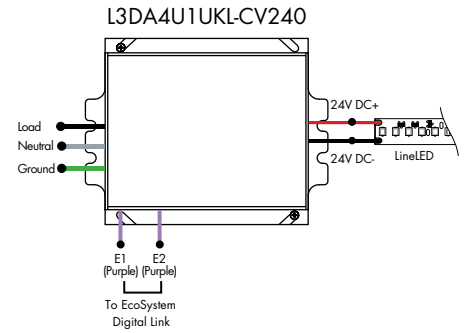

Luminii is a Lutron OEM Advantage Partner

Lutron Power Supplies 0.1%

MODEL

L3D0-96W24V-U

HiLume™ 0.1% EcoSystem Voltage LED Driver with Soft-On, Fade-to-Black™
96W max

MODELS	L3D0
Length	10.50"
Width	5.50"
Depth	2.00"

