

Features

The BOS Channel linear aluminum extrusion has been designed to fit many LED lighting needs. Multiple mounting and lens options allow for great flexibility and adaptability for any application. Extrusion and diffuser lenses are also field cuttable. Substantial aluminum mass in profile provides excellent heat sink for high power LEDs. Channels come with specified Mounting Clips and End Caps.

Finish

Silver anodized, White, Black, Bronze

Diffuser Lens

Polycarbonate, snap-in-place, UV resistant

Mounting

Multiple mounting clips

Warranty

7 Years



Product Dimensions

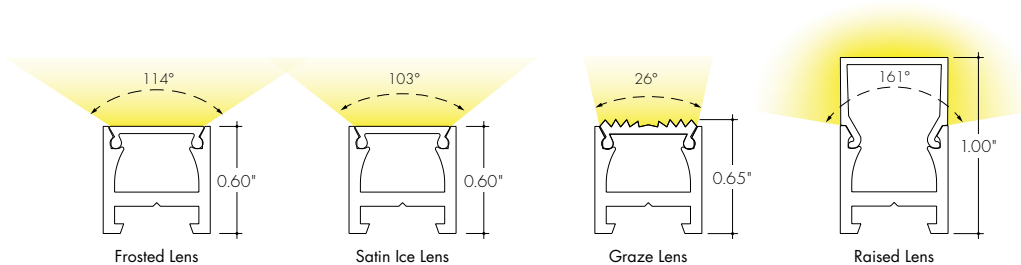
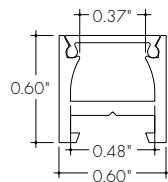

INCLUDED MOUNTING ACCESSORIES

EXTRUSION LENGTH	FIXED CLIP	SCREW-IN/MAGNETIC/ADJUSTABLE	END CAP PAIR
48"	48"	3	1
72"	72"	3	1
96"	96"	4	1
120"	120"	4	1
144"	144"	5	1

TRANSMISSION PERCENTAGE
(COMPARED TO LED TAPE WITHOUT CHANNEL)

LENS	TRANSMISSION %
Graze	76%
Satin Ice	66%
Raised	60%
Frosted	52%

See LED tape spec sheet for lens dotting characteristics & compatibility

Each pair of endcaps includes 1x H3 (no wire feed hole) and 1x H4 (with hole) where applicable. Additional endcaps and mounting clips are available for purchase.

Ordering Code

MODEL	LENGTH	LENS	MOUNTING ²	FINISH ⁴
BOSC-Bosc Channel ¹	48-48" 72-72" 96-96" ³ 120-120" ³ 144-144" ³	F-Frosted SI-Satin Ice G-Graze R-Raised	FC-Fixed Clip SC-Screw-In MAG-Magnetic A-Adjustable Hinge Mounting	BASE SA-Silver Anodized POWDER COATED BK-Black BZ-Bronze WH-White

1 - End Caps are included with channel, one of H3 (no hole) and one of H4 (with hole). Order additional End Caps as necessary.
 2 - Mounting Clips are included with channel. Refer to chart above for provided mounting clip quantities. Order additional Mounting Clips as necessary.
 3 - For Channels and lenses over 96", incremental shipping charges will apply.
 4 - Non Base finishes may have extended lead times. Custom RALs are available, please consult Inside Sales with specific request.

Bosca Channel Corner Options

BOSC-FC-90
Flat Corner

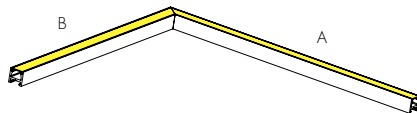
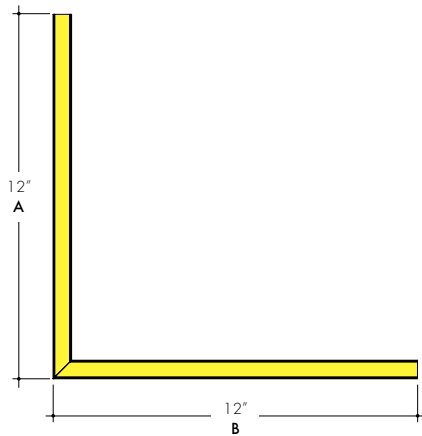

Dimensions measured from the mounting surface face

BOSC-IC-90
Inner Corner

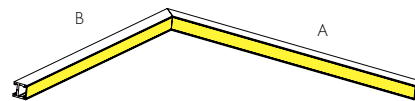
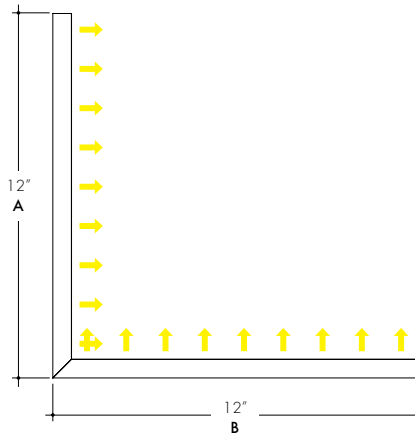

Dimensions measured for the length of the outer (longer) edge of the extrusion

BOSC-OC-90
Outside Corner

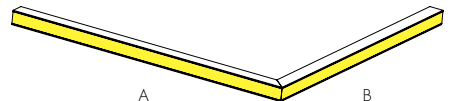
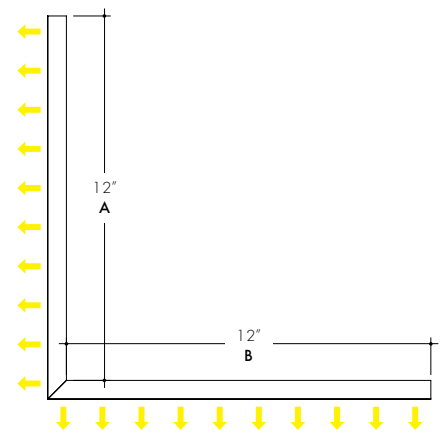

Dimensions measured from the mounting surface face

Ordering Code

MODEL	CORNER TYPE	CORNER ANGLE ²	LENS	MOUNTING ³	FINISH ⁴
BOSC-Bosca Channel ¹	IC-Inner Corner FC-Flat Corner OC-Outer Corner	90-90°	F-Frosted SI-Satin Ice G-Graze R-Raised	FC-Fixed Clip SC-Screw-In MAG-Magnetic	<p><i>BASE</i></p> <p>SA-Silver Anodized</p> <hr/> <p><i>POWDER COATED</i></p> <p>BK-Black BZ-Bronze WH-White</p>

1 - End Caps are not included with channel, order End Caps as necessary.
 2 - Custom Corner angle are available upon request.
 3 - 2 Mounting Clips are included with each corner. Order additional Mounting Clips as necessary.
 4 - Powder Coat finishes may have extended lead times. Custom RALs are available, please consult Inside Sales with specific request.

Mounting Clips

MC-BOSC-SNAP-XX
Fixed Clip
-FC

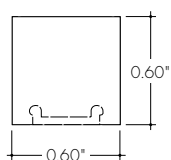

Fixed Clip

MB-BOSC-XX
Screw-in mounting bracket
-SC

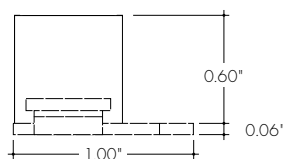

Screw-in

MB-BOSC-MAG
Magnetic bracket
-MAG

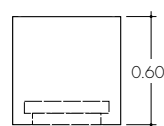

Magnetic Bracket

MB-BOSC-A-XX
Adjustable Mounting Bracket
-A

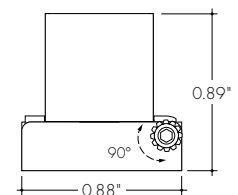

Adjustable Bracket

*Not available with corners

All Channels come with a specified set of Mounting Clips and End Caps, see Ordering Code for details. Order additional Mounting Clips and End Caps as necessary.

Mounting Clips

MC-BOSC-SNAP-XX

Fixed Clip available in 48", 72", 96", 120", 144"
-FC

XX	Length
48	48"
72	72"
96	96"
120	120"
144	144"

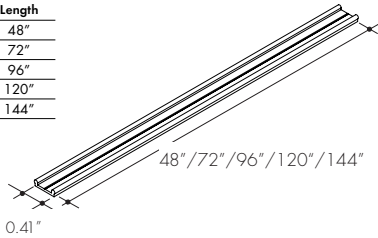

MB-BOSC-XX

Screw-in mounting bracket
-SC

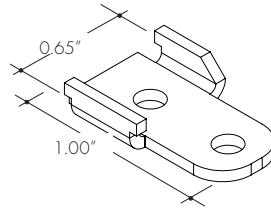

XX	Color
SA	Silver Anodized
WH	White
BK	Black
BZ	Bronze

MB-BOSC-MAG

Magnetic bracket
-MAG

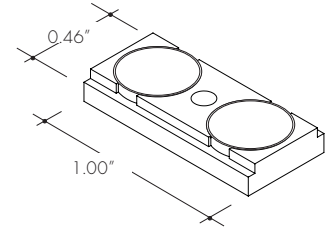

MB-BOSC-A-XX

Adjustable Mounting Bracket*
-A

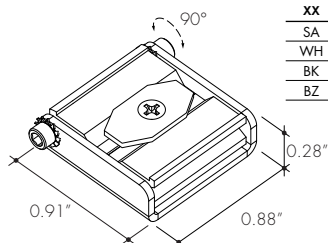

XX	Color
SA	Silver Anodized
WH	White
BK	Black
BZ	Bronze

*Not available with corners

Endcaps

EC-BOS-F-H4-XX

Endcap with powerfeed opening

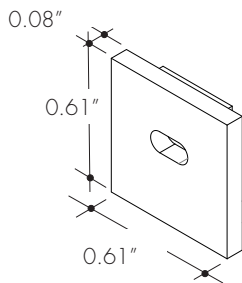

EC-BOS-G-H4-XX

Endcap with powerfeed opening

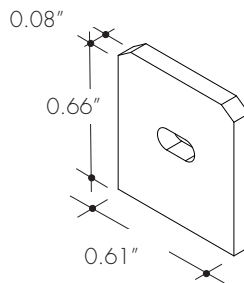

EC-BOS-R-H4-XX

Endcap with powerfeed opening

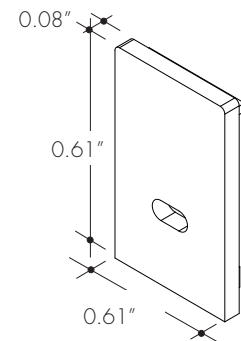

EC-BOS-F-H3-XX

Endcap without powerfeed opening

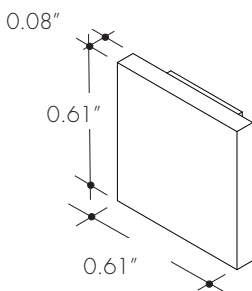

EC-BOS-G-H3-XX

Endcap without powerfeed opening

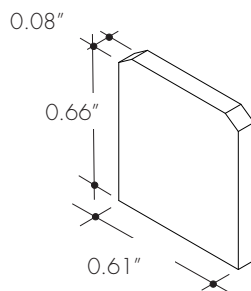

EC-BOS-R-H3-XX

Endcap without powerfeed opening

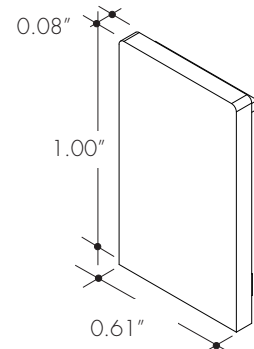

XX	Color
SA	Silver Anodized
WH	White
BK	Black
BZ	Bronze