

Features

The BAR Channel linear aluminum extrusion has been designed to fit many LED lighting needs. Multiple mounting and lens options allow for great flexibility and adaptability for any application. Extrusion and diffuser lenses are also field cuttable. Substantial aluminum mass in profile provides excellent heat sink for high power LEDs. Channels come with specified Mounting Clips and End Caps.

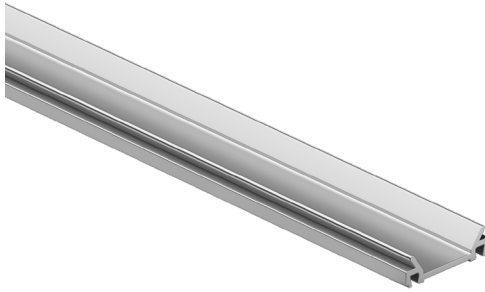

Finish

Silver anodized, White, Black, Bronze

Diffuser Lens

Polycarbonate, snap-in-place, UV resistant

Mounting

Multiple mounting clips

Declare. MADE IN U.S.A.

Product Dimensions

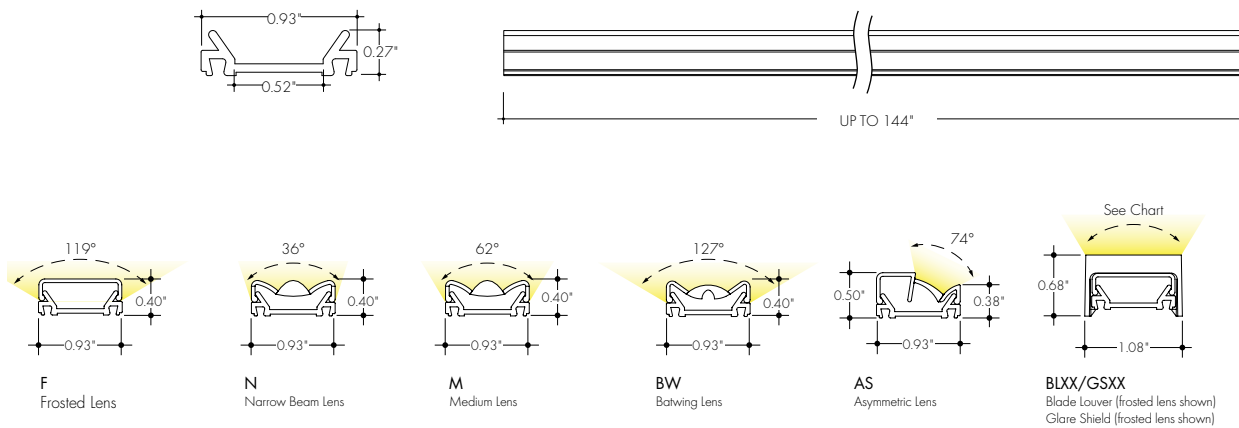

Beam Angles	
Lens	BLXX / GSXX
Narrow Beam	38°
Medium	54°
Batwing	102°
Frosted	100°

INCLUDED MOUNTING ACCESSORIES

EXTRUSION LENGTH	END CAP PAIR	FIXED CLIP	9/16" LAY-IN GRID	15/16" LAY-IN GRID	9/16" TEGULAR CLIP	9/16" SLOT TEE CLIP
48"	1	3	3	3	3	3
72"	1	4	4	4	4	4
96"	1	5	5	5	5	5
120"	1	6	6	6	6	6
144"	1	7	7	7	7	7

Each pair of endcaps includes 1x H3 (no wire feed hole) and 1x H4 (with hole) where applicable. Additional endcaps and mounting clips are available for purchase.

TRANSMISSION PERCENTAGE
(COMPARED TO LED TAPE WITHOUT CHANNEL)

LENS	TRANSMISSION %		
	LENS ONLY	BLXX	GSXX
Batwing	64%	37%	27%
Narrow Beam	63%	43%	31%
Frosted	58%	32%	23%
Medium	56%	38%	27%
Asymmetric	49%	N/A	N/A

See LED tape spec sheet for lens dotting characteristics & compatibility

Ordering Code

MODEL	LENGTH	LENS	MOUNTING ²	FINISH ⁵
BARC-Bara Channel ¹	48-48" 72-72" 96-96" ³ 120-120" ³ 144-144" ³	F-Frosted N-Narrow Beam M-Medium BW-Batwing AS-Asymmetric ⁴	FC-Fixed Clip TB9-9/16" Lay-in Grid TB15-15/16" Lay-in Grid TT9-9/16" Tegular Clip TS9-9/16" Slot Tee Clip	BASE SA-Silver Anodized POWDER COATED WH-White BK-Black BZ-Bronze

- 1 - End Caps are included with channel, one of H3 (no hole) and one of H4 (with hole). Order additional End Caps as necessary.
- 2 - Mounting Clips are included with channel. Refer to chart above for provided mounting clip quantities. Order additional Mounting Clips as necessary.
- 3 - For Channels and lenses over 96", incremental shipping charges will apply.
- 4 - If Asymmetric lens is selected, EC-BAR-AR-H4 and EC-BAR-AL-H4 will be included instead of regular end caps.
- 5 - Non SA finishes may have extended lead times and price adder. Custom RALs are available, please consult Inside Sales with specific request.

All Channels come with a specified set of Mounting Clips and End Caps, see Ordering Code for details. Order additional Mounting Clips and End Caps as necessary.

Mounting Clips

MB-BARC-CB-SS
Bara Fixed Clip
-FC

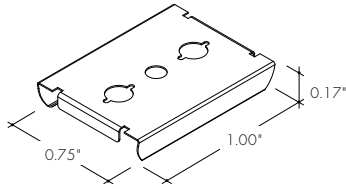

MB-BARC-TB9-SS
Bara 9/16" Lay-in Grid Mounting Bracket
-TB9

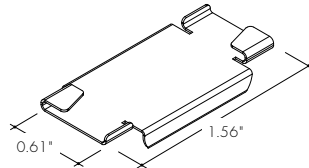

MB-BARC-TB15-SS
Bara 15/16" Lay-in Grid Mounting Bracket
-TB15

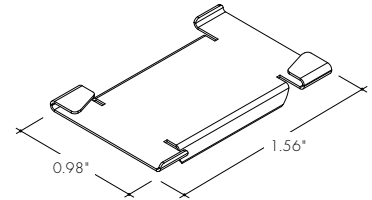

MB-BARC-TS9-SS
Bara 9/16" Slot Tee Mounting Bracket
-TS9

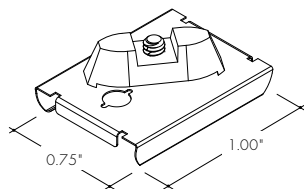

MB-BARC-TT9-SS
Bara 9/16" Tegalur Mounting Bracket
-TT9

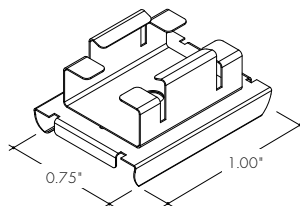

Endcaps

EC-BAR-F-H3-XX
Endcap without powerfeed opening

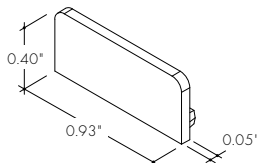

EC-BAR-F-H4-XX
Endcap with powerfeed opening

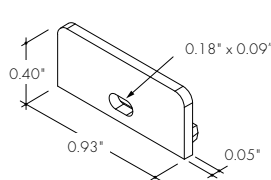

EC-BAR-BL-H4-XX
Endcap with powerfeed opening for Blade Louver

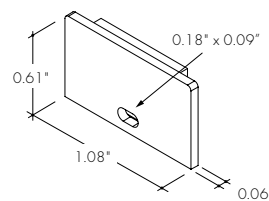

EC-BAR-BL-H3-XX
Endcap without powerfeed opening for Blade Louver

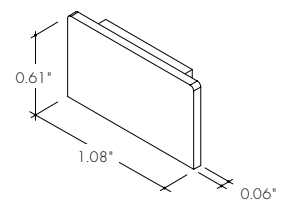

EC-BAR-AL-H4-XX
Endcap with powerfeed opening for Asymmetric Lens left

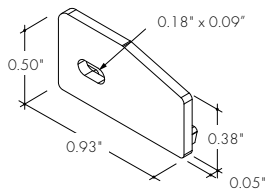

EC-BAR-AR-H4-XX
Endcap with powerfeed opening for Asymmetric Lens right

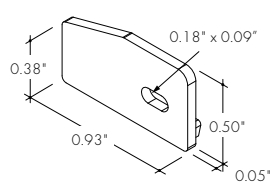

EC-BAR-AL-H3-XX
Endcap for Asymmetric Lens left

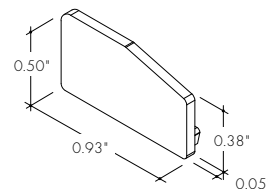

EC-BAR-AR-H3-XX
Endcap for Asymmetric Lens right

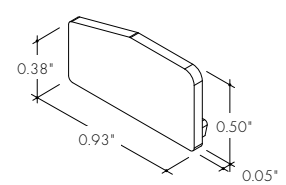

XX	Color
SA	Silver Anodized
WH	White
BK	Black
BZ	Bronze

Blade Louver Accessory - Optional

LV-BL-BARC-24-XX
Blade Louver reduces glare at high angle in two directions
Also available with complete fixture, use ordering code

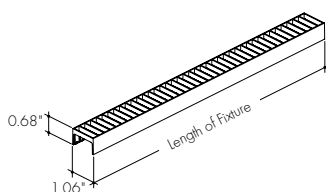

This louver/lens sits on top of Bara lens. Not compatible with asymmetric lens. Make sure to order Blade Louver end caps.

LV-GS-BARC-24-XX
Glare Shield reduces glare at high angle, field cuttable.
Also available with complete fixture, use ordering code

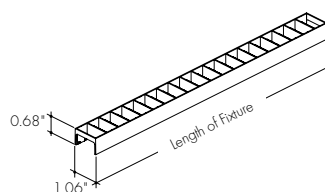

This louver/lens sits on top of Bara lens. Not compatible with asymmetric lens. Make sure to order Blade Louver end caps.

XX	Color
WH	White
BK	Black